

## ÖSTERREICH

### ZENTRALE WELS

**Office & Showroom**  
Europastraße 45  
4600 Wels, Austria  
+43 7242 698-0  
office@moltoluce.com

### PRODUKTION WEISSKIRCHEN

**Office**  
Gewerbepark 6 + 10  
4616 Weißkirchen, Austria  
+43 7243 60063  
office.weisskirchen@moltoluce.com

## WIEN

**Office & Showroom**  
Vorarlberger Allee 28  
1230 Wien, Austria  
+43 1 6160300  
office.wien@moltoluce.com

## GRAZ

**Office**  
Robert-Viertl-Straße 2  
8055 Graz, Austria  
+43 316 672525-0  
office.graz@moltoluce.com

## INNSBRUCK

**Office**  
Orbis Office, Resselstraße 33  
6020 Innsbruck, Austria  
+43 512 345688  
office.innsbruck@moltoluce.com

## DEUTSCHLAND

### MÜNCHEN

**Office & Showroom**  
Walter-Gropius-Straße 23  
80807 München, Germany  
+49 89 4520565-0  
office.muenchen@moltoluce.com

### KÖLN

**Office & Showroom**  
Schanzenstraße 39 D14  
51063 Cologne, Germany  
+49 221 222882-0  
office.koeln@moltoluce.com

### HAMBURG

**Office & Showroom**  
Wandsbeker Allee 77  
22041 Hamburg, Germany  
+49 40 2847850-1  
office.hamburg@moltoluce.com

## SCHWEIZ

### LENZBURG

**Office**  
Niederlenzerstrasse 25  
5600 Lenzburg, Switzerland  
+41 62 885 70 30  
office.lenzburg@moltoluce.com

## ITALIEN

### BRESCIA

**Office & Showroom**  
Viale Duca D'Aosta 28  
25121 Brescia, Italy  
+39 030 2400679  
office.brescia@moltoluce.com



MOLTOLUCE.COM



FR\_04\_24  
12000

kat-tecnico24\_de\_en



MOLTO LUCE®

TECNICO

# TECNICO 2024

STYLE • INDOOR • OUTDOOR • FLEX.light

MOLTO LUCE®

MOLTO LUCE®



## MOLTO LUCE

Als **österreichischer Produzent und Gesamtanbieter für Lichtlösungen** mit mehr als 40 Jahren Erfahrung, gelingt es uns täglich, unsere Kunden mit maßgeschneiderten Beleuchtungskonzepten und einem Service mit Handschlag-Qualität zu begeistern. Unsere Leidenschaft für Licht wird durch herausragende Technik und modernstes Design vervollständigt.

Mit unserem „**People. Power. Planet.**“ Programm gehen wir über den sozialen Aspekt und den Umweltschutz hinaus. Wir setzen den Fokus ebenso darauf, dass unsere Produkte durch eine höchstmögliche Effizienz nicht nur **Energiekosten**, sondern auch **C02 sparen**.

As Austrian producer and single-source supplier for lighting solutions with more than 40 year of experience, we succeed on a daily basis to delight our customers with tailor-made lighting concepts and service with „Handshake-quality“. Our passion for light is completed through superior technology and state-of the art design.

With our „**People. Power. Planet. Programme.**“ we go beyond the social aspect and environmental protection. We also focus on ensuring that our products not only **save energy costs** but also **reduce C02** by maximising efficiency.



## Jetzt Neu: Interaktivität im Katalog

Mit der Vision unseren Kunden mehr zu bieten, als es in einem gedruckten Katalog möglich ist, haben wir die **digitale** Version des TECNICO Katalogs mit spannenden, interaktiven Features ausgestattet. Die Wirkung einer Leuchte **per Knopfdruck** wahrnehmen und über die geschaffene Atmosphäre staunen. Lichtberechnungsdateien, Tageslichtrenderings, Farb- und Modellauswahl, Animationen uvm. machen es möglich. „Wir haben den Unterschied **spürbar** gemacht. Mehr dazu auf [moltoluce.com](http://moltoluce.com)“

## Now new: interactivity in the catalogue

With the aim of providing our customers with more than what is possible in a printed catalogue, we have equipped the digital version of the TECNICO catalogue with exciting interactive features. Experience the effect of a luminaire at the touch of a button and marvel at the atmosphere created. Light calculation files, daylight renderings, colour and model selection, animations and more enable it. „We have made a noticeable difference. Learn more on [moltoluce.com](http://moltoluce.com)“.



## TECNICO

Mit der diesjährigen Ausgabe des TECNICO Kataloges von Molto Luce, setzen wir neue Maßstäbe wenn es um Produkte für's **Daily Business** geht. Mit dem Ziel eine 100%ige Produkt-Verfügbarkeit zu gewährleisten, haben wir durch **lagernde Artikel** die Wartezeiten auf ein Minimum reduziert. „Auf Knopfdruck geliefert.“ Und das **innerhalb von 24h!** In unserem breiten und abwechslungsreichen Sortiment findet man neben dekorativen Produkten mit Fokus auf den **Private und Hospitality Bereich** auch **Outdoor** Produkte sowie **flexible LED** Streifen inkl. Aluminium Profile. Abgerundet wird diese Auswahl durch nützliche **Accessoires** wie Netzgeräte, Leuchtmittel und Controller, die beim individuellen Einsatz oder der Lichtsteuerung helfen.

With this year's edition of the TECNICO catalogue from MoltoLuce catalogue, we are setting new standards when it comes to products for daily business. With the aim of guaranteeing 100% product availability, we have reduced waiting times to a minimum by keeping items in stock. „Delivered at the touch of a button.“ And within 24 hours! In our wide and diverse assortment decorative products with focus on the private and hospitality sector, outdoor products and flexible outdoor products as well as flexible LED strips incl. aluminium profiles can be found. This selection is rounded off by useful accessories such as power supply units, light sources and controllers which help with customised use cases or lighting control.

## Produktvielfalt für alle Anwendungsbereiche

Die Produktvielfalt von MOLTO LUCE kennt so gut wie keine Grenzen. Neben den Daily Business Produkten des TECNICO Katalogs bieten unser **Konfigurator** sowie unsere weiteren **Produktfolder- und Kataloge** eine große Auswahl an qualitativen Lichtlösungen für die individuellen Einsatzbereiche. Egal ob **Industrie, Office, Retail** oder **Private Living** – mit unseren Produkten liegt man immer richtig.

## Product variety for all areas of application

MOLTO LUCE's product diversity knows virtually no bounds. In addition to the products listed in the TECNICO catalogue, our **configurator** and other **product folders** provide a wide selection of options for **industries, offices, retail spaces, and private residences**. MOLTO LUCE offers an extensive range of high-quality lighting solutions for various applications. Our products are always the perfect choice.







## STYLE

VUTO PD	S. 008/P. 008
MELLI F	S. 010/P. 010
MELLI SDI	S. 012/P. 012
MELLI SD	S. 012/P. 012
MEYJO T	S. 016/P. 016
MEYJO F	S. 016/P. 016
PERFORA M	S. 020/P. 020
PERFORA L	S. 020/P. 020
PERFORA PRO M	S. 022/P. 022
PERFORA PRO L	S. 022/P. 022
PERFORA PRO XL	S. 022/P. 022
NUUN SD	S. 024/P. 024
NUUN PD	S. 024/P. 024
GILO PD	S. 026/P. 026
MIMO T	S. 028/P. 028
MIMO F	S. 028/P. 028
MIMO DOUBLE F	S. 028/P. 028
EEDEN S T	S. 030/P. 030
EEDEN M T	S. 031/P. 031
EEDEN M F 1	S. 032/P. 032
EEDEN M F 2	S. 032/P. 032
EEDEN M PD	S. 033/P. 033

## INDOOR

CHICCO ROUND R	S. 038/P. 038
IVY ROUND R	S. 038/P. 038
SUNRAY I/II/III/IV	S. 040/P. 040
SPEAKER 1/2	S. 042/P. 042
ENERGY 2130/2180/2245	S. 042/P. 042
AGON FLAT	S. 044/P. 044
AGON ROUND	S. 045/P. 045
SATOR	S. 046/P. 046
PONTOS ROUND	S. 046/P. 046
KALIO ROUND	S. 047/P. 047
ELIX MINI R	S. 048/P. 048
ELIX R	S. 048/P. 048
SERIE 146 HV GU10	S. 050/P. 050
SERIE 223 HV GU10	S. 050/P. 050
SERIE 3380 HV GU10	S. 050/P. 050
SERIE 015 G4	S. 051/P. 051
SERIE 1101 HV GU10	S. 051/P. 051
WILLI 68R	S. 052/P. 052
SERIE 68 HV GU10	S. 054/P. 054
SERIE 332 HV GU10	S. 054/P. 054
QANA ROUND R	S. 054/P. 054
LIRO R	S. 058/P. 058
CHICCO SQUARE R	S. 060/P. 060
IVY SQUARE R	S. 060/P. 060
KALIO SQUARE R	S. 061/P. 061
AGON FLAT SQUARE	S. 062/P. 062
AGON SQUARE	S. 062/P. 062
SATOR SQUARE	S. 064/P. 064
PONTOS SQUARE	S. 064/P. 064
SERIE 4236 HV GU10	S. 066/P. 066
QANA SQUARE R	S. 066/P. 066
QANA DOUBLE SQUARE R	S. 066/P. 066
MOON ROUND R	S. 070/P. 070
MOON SQUARE R	S. 070/P. 070
MAAN SQUARE	S. 072/P. 072
MAAN ROUND	S. 072/P. 072
AEON ROUND SMALL	S. 080/P. 080
AEON ROUND BIG	S. 080/P. 080
AEON SQUARE SMALL	S. 082/P. 082
AEON SQUARE BIG	S. 082/P. 082
POLUS	S. 084/P. 084
UP AC	S. 084/P. 084
LIRO SD	S. 084/P. 084
CARMİ	S. 086/P. 086
ARIK SHORT	S. 087/P. 087
DESCO M	S. 088/P. 088
DESCO L	S. 088/P. 088
MAG SDI	S. 090/P. 090
MAG SD TURN	S. 090/P. 090
MAGIS MINI SD	S. 092/P. 092
MAGIS MINI DOUBLE SD	S. 092/P. 092
MAGIS SD	S. 094/P. 094
MAGIS DOUBLE SD	S. 094/P. 094
MISSOR I	S. 098/P. 098
MISSOR II	S. 098/P. 098
MISSOR I SD GU10	S. 100/P. 100
MISSOR II SD GU10	S. 100/P. 100
MISSOR III SD GU10	S. 100/P. 100
MISSOR III SD GU10	S. 100/P. 100
QANA ROUND SD	S. 102/P. 102

QANA BOX 1 SD	S. 102/P. 102
QANA BOX 2 SD	S. 102/P. 102
MUSO ROUND SD	S. 106/P. 106
MUSO ROUND SD SENSOR	S. 106/P. 106
MUSO ROUND SD DALI	S. 106/P. 106
MUSO SQUARE SD	S. 108/P. 108
MUSO SQUARE SD SENSOR	S. 108/P. 108
MUSO LINEAR SD	S. 110/P. 110
MUSO 120 LINEAR CCT DALI	S. 110/P. 110
ALKOR 2 E27	S. 112/P. 112
APUS E27	S. 112/P. 112
ELSA E27	S. 112/P. 112
DELIA E27	S. 114/P. 114
DELIA	S. 114/P. 114
AURA E27	S. 116/P. 116
TITAN E27	S. 116/P. 116
LINA E27	S. 118/P. 118
TILIA E27	S. 118/P. 118
ISIS E27	S. 120/P. 120
FORO SHORT PD	S. 124/P. 124
FORO LONG PD	S. 124/P. 124
NOVEL	S. 126/P. 126
ALICA	S. 126/P. 126
BO SINGLE	S. 128/P. 128
BO DOUBLE	S. 128/P. 128
TAKE 69	S. 128/P. 128
AROK	S. 130/P. 130
CLARUS	S. 131/P. 131
SERIE 44 SHORT SD	S. 132/P. 132
SERIE 44 LONG SD	S. 132/P. 132
MATAR	S. 132/P. 132
LANU ROUND W	S. 134/P. 134
LANU FLAT W	S. 135/P. 135
MOTUS LONG W	S. 136/P. 136
ZHOOM W	S. 136/P. 136
WALL 68R	S. 140/P. 140
WALL 68R IP44	S. 142/P. 142
WINDOW I	S. 144/P. 144
PAN	S. 144/P. 144
WINDOW II	S. 145/P. 145
3-PHASE SCHIENE/TRACK	S. 148/P. 148
3-PHASE SCHIENE DALI/TRACK DALI	S. 150/P. 150
MOOVE TRACK	S. 154/P. 154
SHOPSTAR LEAN TRACK	S. 154/P. 154
MAG TRACK	S. 156/P. 156
MAGIS TRACK	S. 156/P. 156
TRACK SET MOOVE	S. 158/P. 158
TRACK SET MAG	S. 159/P. 159
RETRO 595R	S. 162/P. 162
RETRO 620R	S. 162/P. 162
RETRO 1230R	S. 162/P. 162
FIT	S. 164/P. 164
FIT LONG	S. 164/P. 164
RUBE PDI	S. 166/P. 166



## OUTDOOR

IVY ROUND R	S. 174/P. 174
CHICCO ROUND	S. 174/P. 174
IVY SQUARE R	S. 176/P. 176
CHICCO SQUARE	S. 176/P. 176
NONA MINI	S. 179/P. 179
NONA	S. 179/P. 179
FORIS SD	S. 181/P. 181
WILLIAM SD	S. 181/P. 181
FORIS W	S. 183/P. 183
FORIS DOUBLE W	S. 183/P. 183
WILLIAM W	S. 183/P. 183
SOPO ROUND M	S. 185/P. 185
SOPO ROUND L	S. 185/P. 185
SOPO SQUARE M	S. 185/P. 185
SOPO SQUARE L	S. 185/P. 185
TURN 2 SD GU10	S. 186/P. 186
FYNN 0 SD	S. 186/P. 186
LINE 25W	S. 188/P. 188
LINE 25 DOUBLE	S. 188/P. 188
LINE 50W	S. 188/P. 188
LINE 50 DOUBLE	S. 188/P. 188
WADO W	S. 190/P. 190
WADO DOUBLE W	S. 190/P. 190
CORBA ROUND W	S. 191/P. 191
CORBA SQUARE W	S. 191/P. 191
NEXT W	S. 192/P. 192
BEN ROUND W	S. 192/P. 192
BEN SQUARE W	S. 192/P. 192
PARE W	S. 194/P. 194
NELL W	S. 195/P. 195
FOCO W	S. 195/P. 195
PIGO W	S. 196/P. 196
ZEON W	S. 196/P. 196
FYNN C W	S. 196/P. 196
KODA TEN ONE	S. 198/P. 198
KODA TEN TWO	S. 198/P. 198
KODA TEN STRETTO	S. 198/P. 198
KODA TWENTY ONE	S. 198/P. 198
KODA TWENTY TWO	S. 198/P. 198
KODA THIRTY ONE	S. 199/P. 199
KODA THIRTY TWO	S. 199/P. 199
CADO MINI W	S. 200/P. 200
CADO W	S. 201/P. 201
MONA MINI F	S. 204/P. 204
MONA F	S. 204/P. 204
YARA ROUND F	S. 206/P. 206
YARA SQUARE F	S. 206/P. 206
ZEON F	S. 207/P. 207
BOOPER F	S. 208/P. 208
ALIAR F	S. 208/P. 208
WILLIAM F	S. 211/P. 211
FYNN CP F	S. 211/P. 211
CHOPA F	S. 214/P. 214
HARK	S. 214/P. 214
FORIS F	S. 215/P. 215
MICRO RODIO SYM.	S. 216/P. 216
MICRO RODIO L SYM.	S. 216/P. 216
MINI RODIO SYM.	S. 217/P. 217
RODIO SYM. LED	S. 217/P. 217
ZUBEHÖR/ACCESSOIRES	S. 218/P. 218



## FLEX.light

KONFIGURATOR/CONFIGURATOR	S. 224/P. 224
FLEX.light VANTI	S. 228/P. 228
FLEX.light LATO	S. 230/P. 230
FLEX.light COLLINA	S. 232/P. 232
FLEX.light PREMIUM 5W	S. 234/P. 234
FLEX.light PREMIUM 9W	S. 235/P. 235
FLEX.light PREMIUM 18W	S. 235/P. 235
FLEX.light PREMIUM 28W	S. 235/P. 235
FLEX.light BASIC 4,8W	S. 238/P. 238
FLEX.light BASIC 9,6W	S. 238/P. 238
FLEX.light BASIC 14,4W	S. 240/P. 240
FLEX.light DIM2WARM 14,4W	S. 242/P. 242
FLEX.light TUNABLE WHITE 14,4W	S. 242/P. 242
FLEX.light RGBW 18,1W	S. 244/P. 244
FLEX.light 4,8W (IP67)	S. 246/P. 246
FLEX.light TUNABLE WHITE 14,4W (IP67)	S. 247/P. 247
FLEX.light RGBW 18,1W (IP67)	S. 248/P. 248
FLEX.light BASIC 48V 4,8W (IP67)	S. 250/P. 250
AUFBAUPROFILE/SURFACE PROFIL	S. 252/P. 252
EINBAUPROFILE/RECESSED PROFIL	S. 262/P. 262

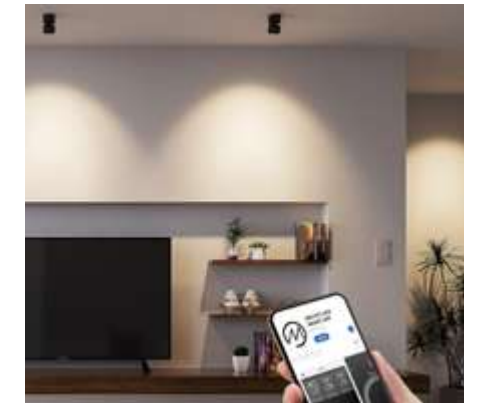

## ACCESSOIRES

KONSTANTSPANNUNGSKONVERTER/ CONSTANT VOLTAGE DRIVER	S. 266/P. 266
KONSTANTSPANNUNGSKONVERTER DIM/ CONSTANT VOLTAGE DRIVER DIM.	S. 270/P. 270
DALI STEUERUNG/ DALI CONTROL	S. 274/P. 274
LICHTSZENEKONTROLLER DALI/ LIGHT SCENE CONTROLLER DALI	S. 275/P. 275
FUNK-STEUERUNG/ RADIO CONTROLLER	S. 275/P. 275
BLUETOOTHSTEUERUNG/ BLUETOOTH CONTROLLER	S. 277/P. 277
TRANSFORMATOREN/ TRANSFORMER	S. 278/P. 278
KONSTANTSTROM KONVERTER/ CONSTANT CURRENT DRIVER	S. 279/P. 279
KONSTANTSTROM KONVERTER DIM/ CONSTANT CURRENT DRIVER DIM	S. 283/P. 283
LEUCHTMITTEL/ BULBS	S. 290/P. 290
SCHALTPLÄNE/WIRING DIAGRAMS	S. 294/P. 294

# INDEX



# TECNICO STYLE





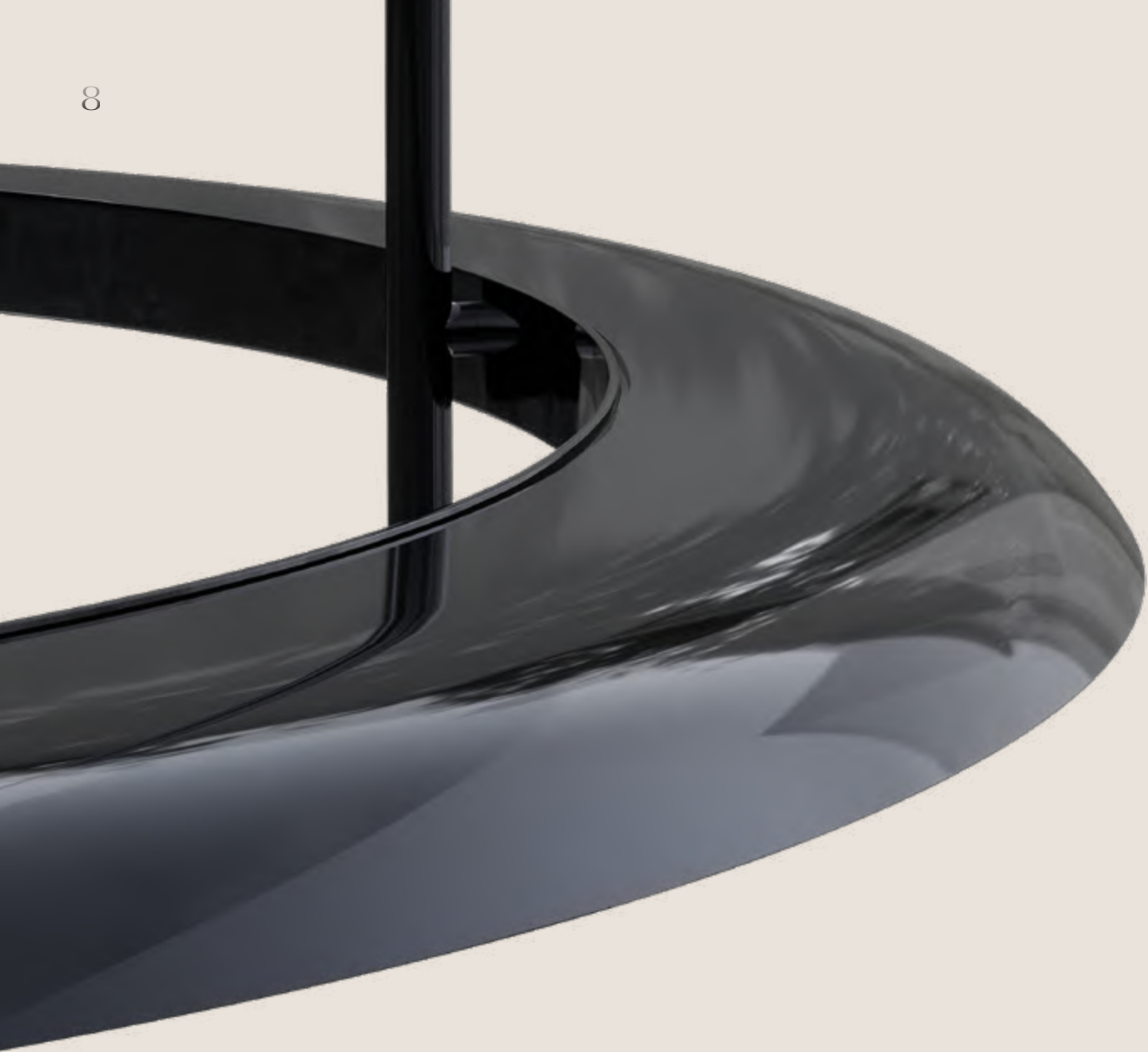

# VUTO NEW

„Anello vuoto“ bedeutet „leerer Ring“. Dabei heißt „vuoto“ so viel wie „leer“ und erinnert an das Wort „Voute“, was Gewölbe bedeutet. Dies spiegelt sich im Konzept der Leuchte wieder. Eine elegante, flache Designerleuchte, entworfen von Johannes Tomm. Die Leuchte wird in zwei Oberflächen verfügbar sein. In einem edlem Klavierlack Schwarz oder optional in einem schlichteren Schwarz matt mit weißem Reflektor für eine effizientere Ausleuchtung. Unsere VUTO schwebt dank zwei sehr filigranen Halterungs-Stäben zeitlos im Raum. Die Leuchte wird DALI dimmbar und in der Lichtfarbe 2700K mit einem CRI90 erhältlich sein.

„Anello vuoto“ means „empty ring“. However, „vuoto“ means as „empty“ and is reminiscent of the word „voute“, which means arch. This is reflected in the concept of the luminaire. An elegant, flat designer luminaire, designed by Johannes Tomm. The luminaire will be available in two finishes. In an elegant black piano lacquer or optionally in a simpler matt black with a white reflector for more efficient illumination. Our VUTO floats timelessly in the room thanks to two very delicate mounting rods. The luminaire is DALI dimmable and available in the light colour 2700K with a CRI90.

## VUTO PD



ART. NR./CODE	LEISTUNG/POWER	LUMEN	CRI>	KELVIN	Ø x H	Abh./Susp.	FARBE/COLOUR	PREIS/PRICE
222-00110	SYS 35W	900	90	2700	600 x 330	4000	black/white	999,00
222-00111	SYS 35W	900	90	2700	600 x 330	4000	glossy black/white	1099,00





Elegantes Design gepaart mit technischen Raffinessen setzt stilvolle Akzente in jedem Raum.

Elegant design paired with technical refinements sets stylish accents in any room.

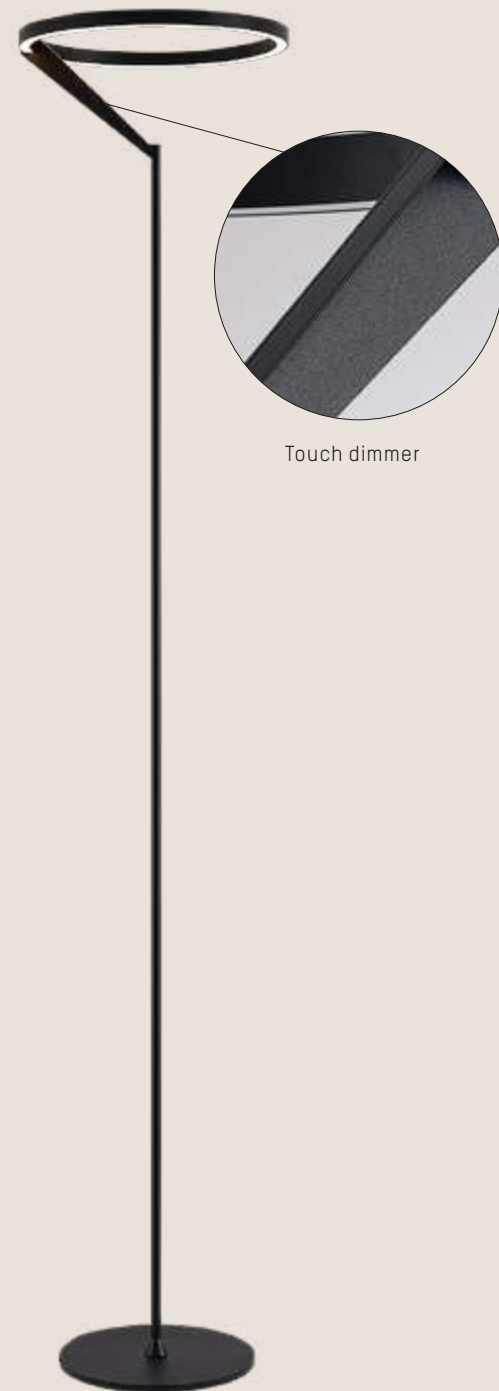

Touch dimmer

## MELLI F

ART. NR./CODE	LEISTUNG/POWER	LUMEN	CRI>	KELVIN	Ø x H	FARBE/COLOUR	REFL.	PREIS/PRICE
222-00039	SYS 20W	960	90	2700/3000	330 x 1680	black	110°	499,00



# MELLI F



Die elegante Stehleuchte MELLI beeindruckt mit ihrem filigranen Leuchtendesign und setzt stilvolle Akzente in jedem Raum. Dank der einstellbaren Lichtfarbe (2700/3000K) können individuelle Lichtstimmungen geschaffen werden. Die Stehleuchte verfügt über einen praktischen Touchdimmer, der stufenloses Dimmen ermöglicht. Das hochwertige Gehäuse mit schwarzer Pulverbeschichtung verleiht MELLI eine edle Optik.

The elegant MELLI floor lamp impresses with its filigree luminaire design and sets stylish accents in any room. Thanks to the adjustable light colour (2700/3000K), individual lighting moods can be created. The floor lamp has a practical touch dimmer that allows infinitely variable dimming. The high-quality housing with black powder coating gives MELLI a noble look.





# MELLI

Stilvoll und funktional präsentiert sich die Leuchtenserie MELLI. Hergestellt aus hochwertigem Aluminium und in elegantem Schwarz gehalten, besticht sie durch ihr schlichtes Design und ihre vielseitigen Anwendungsmöglichkeiten. Egal, ob als Wand- oder Deckenleuchte oder sogar als Stehleuchte, sie erzeugt ein angenehmes Licht und schafft eine gemütliche Atmosphäre. Die Lichtfarbe kann je nach persönlichen Vorlieben zwischen warmweißem 2700K und neutralweißem 3000K variiert werden. Dies sollte vor der Montage eingestellt werden. Darüber hinaus kann MELLI je nach gewünschter Lichtwirkung entweder indirekt oder direkt/indirekt strahlend im Raum für perfekte Lichtstimmung sorgen.

The MELLI luminaire series is stylish and functional. Made from high-quality aluminium and finished in elegant black, it impresses with its simple design and versatile application options. Whether as a wall or ceiling light or even as a floor lamp, it produces a pleasant light and creates a cosy atmosphere. The light colour can be varied between warm white 2700K and neutral white 3000K depending on personal preference. This should be set before installation. In addition, depending on the desired lighting effect, MELLI can provide either indirect or direct/indirect light in the room to create the perfect lighting mood.

## MELLI SDI direkt-indirekt/direct-indirect



ART. NR./CODE	LEISTUNG/POWER	LUMEN	CRI>	KELVIN	Ø x H	FARBE/COLOUR	PREIS/PRICE
222-00037	SYS 30W	1080/1140	90	2700/3000	330 x 146	black	399,00



## MELLI SD indirekt/indirect



ART. NR./CODE	LEISTUNG/POWER	LUMEN	CRI>	KELVIN	Ø x H	FARBE/COLOUR	PREIS/PRICE
222-00038	SYS 15W	490/520	90	2700/3000	330 x 135	black	349,00



**MELLI SDI**  
direkt-indirekter Lichtaustritt  
direct-indirect light emission



**MELLI SD**  
indirekter Lichtaustritt  
indirect light emission



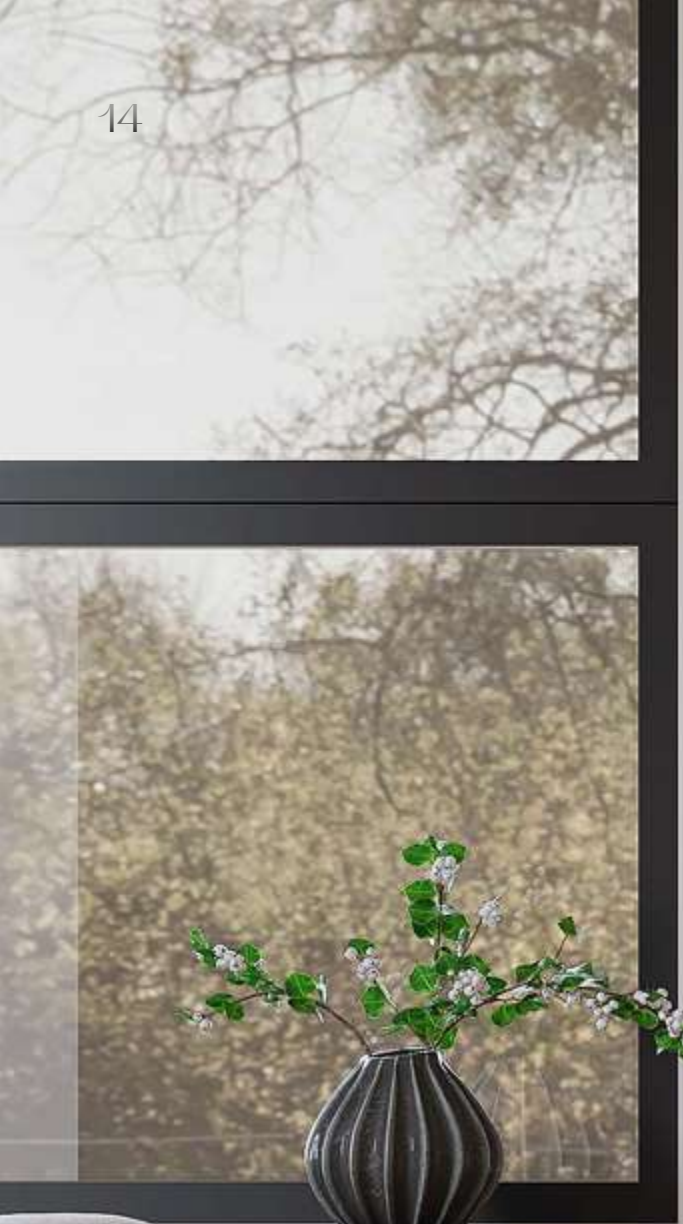



Mit einer angenehmen Farbtemperatur erzeugt MEYJO eine behagliche Atmosphäre und steigert das Wohlbefinden.

With a pleasant colour temperature, MEYJO creates a cosy atmosphere and increases well-being.

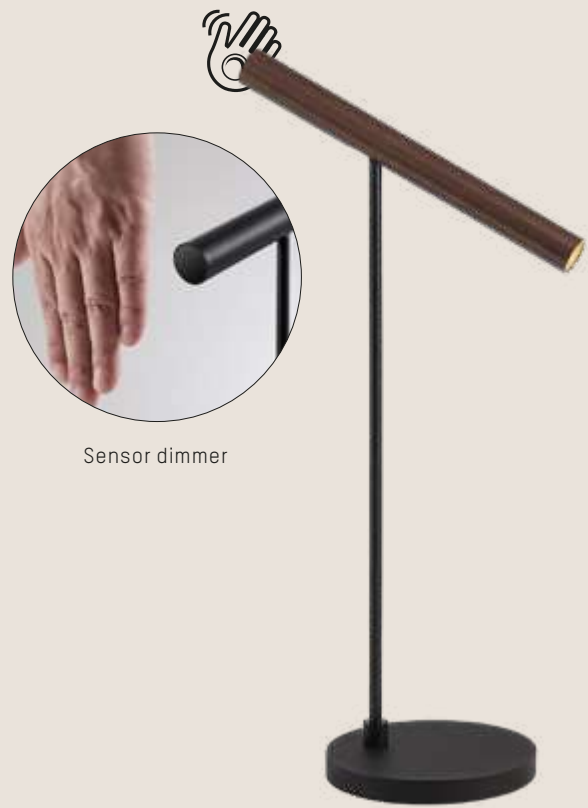

Sensor dimmer



### MEYJO T



ART. NR./CODE	LEISTUNG/POWER	LUMEN	CRI>	KELVIN	Ø x H x L/Ø x H x L	FARBE/COLOUR	REFL.	PREIS/PRICE
222-00048	SYS 9W	450	90	2700	140 x 435 x 250	black/black	28°	290,00
222-00049	SYS 9W	450	90	2700	140 x 435 x 250	black/gold	28°	290,00
222-00050	SYS 9W	450	90	2700	140 x 435 x 250	black/coffee	28°	290,00



### MEYJO F



ART. NR./CODE	LEISTUNG/POWER	LUMEN	CRI>	KELVIN	Ø x H x L/Ø x H x L	FARBE/COLOUR	REFL.	PREIS/PRICE
222-00051	SYS 9W	450	90	2700	250 x 1400 x 250	black/black	28°	390,00
222-00052	SYS 9W	450	90	2700	250 x 1400 x 250	black/gold	28°	390,00
222-00053	SYS 9W	450	90	2700	250 x 1400 x 250	black/coffee	28°	390,00



# MEYJO T/F



Die überarbeitete Tisch- und Stehleuchte MEYJO beeindruckt mit einer verbesserten Sensorensteuerung, die das Bedienen noch intuitiver gestaltet. Mithilfe der innovativen Gestensteuerung durch einen versteckten Sensor, lässt sich die Leuchte mühelos kontrollieren. Die stufenlose Dimmfunktion ermöglicht eine präzise Anpassung des Lichts an individuelle Bedürfnisse. Die neue MEYJO hat eine Höhe von nur mehr 1,4m, was erhöhte Stabilität bedeutet. Zudem erstrahlt die Leuchte in neuen, attraktiven Farbvarianten wie Schwarz, Gold gebürstet und Coffee gebürstet.

The improved MEYJO table and floor luminaire impresses with an improved sensor control that makes operation even more intuitive. The luminaire can be controlled effortlessly with the help of the innovative gesture control via a hidden sensor. The infinitely variable dimming function enables precise adjustment of the light to individual needs. The new MEYJO has a height of only 1.4m, which leads to increased stability. In addition, the luminaire shines in new, attractive colour variations such as black, brushed gold and brushed coffee.





# PERFORA





Die neue PERFORA lässt ab sofort auch das Einstellen der Lichtfarbe auf 2700K oder 3000K zu. Dadurch lässt sich die Farbtemperatur an individuelle Vorlieben anpassen.

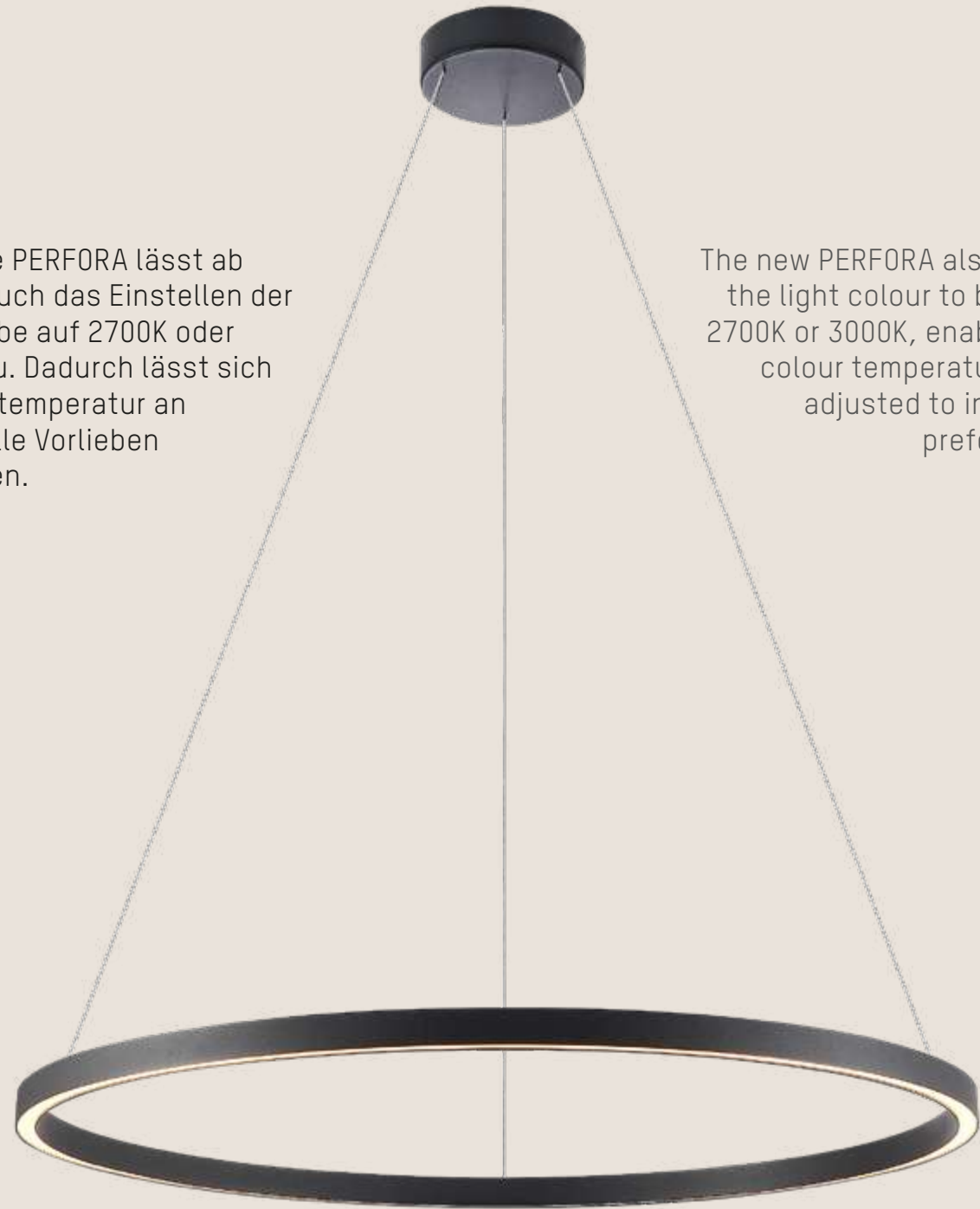

The new PERFORA also allows the light colour to be set to 2700K or 3000K, enabling the colour temperature to be adjusted to individual preferences.

### PERFORA M



ART. NR./CODE	LEISTUNG/POWER	LUMEN	CRI>	KELVIN	Ø x H	Abh./Susp.	FARBE/COLOUR	PREIS/PRICE
222-00073	SYS 38W	1870/2020	90	2700/3000	600 x 30	2000	white	669,00
222-00074	SYS 38W	1870/2020	90	2700/3000	600 x 30	2000	black	669,00

### PERFORA L



ART. NR./CODE	LEISTUNG/POWER	LUMEN	CRI>	KELVIN	Ø x H	Abh./Susp.	FARBE/COLOUR	PREIS/PRICE
222-00075	SYS 65W	2890/3180	90	2700/3000	900 x 30	2000	white	959,00
222-00076	SYS 65W	2890/3180	90	2700/3000	900 x 30	2000	black	959,00

# PERFORA



Die stillichere Ringleuchte PERFORA begeistert mit ihrer neuen Funktion: einer einstellbaren Lichtfarbe von 2700K oder 3000K. Damit bietet sie die Möglichkeit, die Farbtemperatur ganz nach individuellen Vorlieben anzupassen. Zudem ist PERFORA DALI dimmbar, wodurch die Lichtintensität flexibel reguliert werden kann. Das hochwertige pulverbeschichtete Finish verleiht der Leuchte eine edle Optik und sorgt für eine langlebige Oberfläche.

The stylish PERFORA ring luminaire inspires with its new function of an adjustable light colour of 2700K or 3000K. This luminaire offers the possibility of adjusting the colour temperature entirely according to individual preferences. In addition, PERFORA DALI is dimmable, allowing the light intensity to be flexibly regulated. The high-quality powder-coated finish gives the luminaire a noble appearance and ensures a long-lasting surface.





# PERFORA PRO NEW

Die direkt- und indirekt leuchtend erhältliche PERFORA PRO kombiniert Nutzen und Design wie keine andere. Dank der niedrigen Blendwirkung (UGR18) und der angenehmen Farbtemperaturen von 2700K oder 3000K schafft sie ein dezentes aber doch wirkungsvolles Lichtelebnis. Die Leuchte ist per DALI2 und PUSH DIM steuerbar.

Available with direct and indirect light, PERFORA PRO combines utility and design like no other. Thanks to the low glare effect (UGR18) and the pleasant colour temperatures of 2700K or 3000K, it creates a discreet yet effective lighting experience. The luminaire can be controlled via DALI2 and PUSH DIM.



## PERFORA PRO M direkt-indirekt/direct-indirect

ART. NR./CODE	LEISTUNG/POWER	LUMEN	CRI>	KELVIN	Ø x H/Ø x H	Abh./Susp.	FARBE/COLOUR	PREIS/PRICE
222-00156	SYS 45W	↓ 2320/3480↑	90	2700/3000	655 x 38	3000	black	799,00

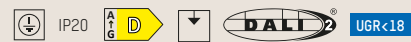

## PERFORA PRO L direkt-indirekt/direct-indirect

ART. NR./CODE	LEISTUNG/POWER	LUMEN	CRI>	KELVIN	Ø x H/Ø x H	Abh./Susp.	FARBE/COLOUR	PREIS/PRICE
222-00157	SYS 60W	↓ 3120/6240↑	90	2700/3000	905 x 38	3000	black	999,00



## PERFORA PRO XL direkt-indirekt/direct-indirect

ART. NR./CODE	LEISTUNG/POWER	LUMEN	CRI>	KELVIN	Ø x H/Ø x H	Abh./Susp.	FARBE/COLOUR	PREIS/PRICE
222-00158	SYS 80W	↓ 4160/6240↑	90	2700/3000	1205 x 38	3000	black	1249,00







# NUUN NEW

Namensgeber sind die U-förmigen Leuchtenköpfe die auf der mattschwarzen Mittelstange angereiht sind. Gold oder coffee gebürstet kombiniert mit matt schwarz wirkt sie elegant als Pendel über dem Esstisch oder als variabel einstellbare Aufbauleuchte. Die Köpfe sind dreh- und schwenkbar. Die Leuchte selbst ist über einen DIP-Switch 2700/3000K einstellbar und DALI dimmbar. Die Leuchtenserie NUUN ist somit eine elegante und dekorative Ergänzung im TECNICO STYLE



Named by the U-shaped luminaire heads, which are arranged on the matt black centre bar. Brushed gold or coffee combined with matt black, it looks elegant as a pendant above the dining table or as a variably adjustable surface-mounted luminaire. The heads can be swivelled and tilted. The light itself is adjustable via a dipswitch 2700/3000K and DALI dimmable. The NUUN luminaire series is therefore an elegant and decorative addition to the TECNICO STYLE

## NUUN SD

ART. NR./CODE	LEISTUNG/POWER	LUMEN	CRI>	KELVIN	L x B x H/L x W x H	FARBE/COLOUR	PREIS/PRICE
222-00126	SYS 18W	1410	90	2700/3000	900 x 70 x 245	black/gold	499,00
222-00127	SYS 18W	1410	90	2700/3000	900 x 70 x 245	black/coffee	499,00

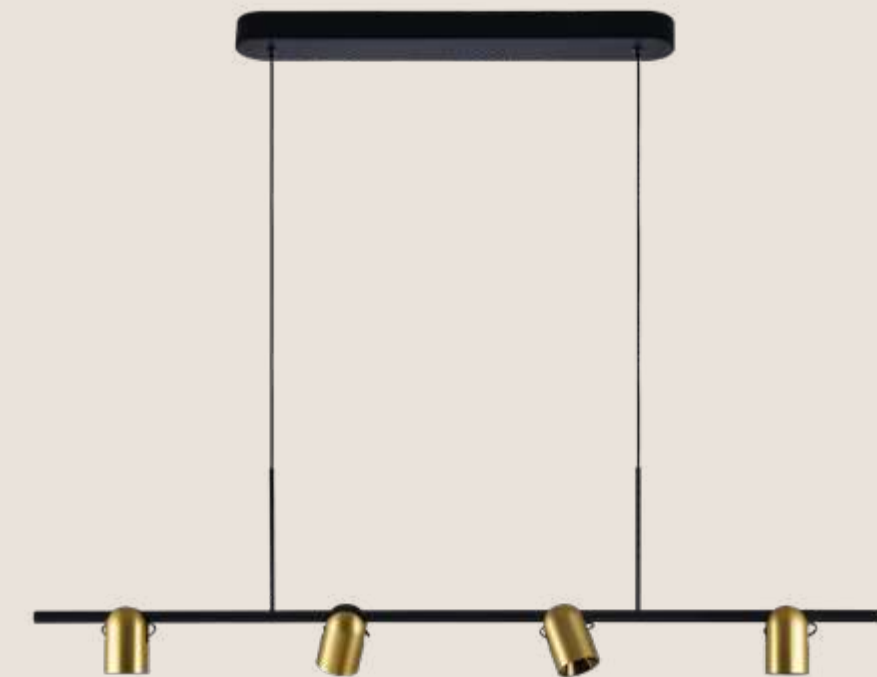

## NUUN PD

ART. NR./CODE	LEISTUNG/POWER	LUMEN	CRI>	KELVIN	L x B x H/L x W x H	Abh./Susp.	FARBE/COLOUR	PREIS/PRICE
222-00124	SYS 25W	1880	90	2700/3000	1150 x 60 x 90	2500	black/gold	649,00
222-00125	SYS 25W	1880	90	2700/3000	1150 x 60 x 90	2500	black/coffee	649,00





## GILO



Die schlichte und minimalistische Hängeleuchte aus Aluminiumdruckguss GILO PD mit opalem Acryl Diffusor glänzt durch zeitloses Design. Die pulverbeschichtete Oberfläche sowie der Konverter und Deckenbaldachin sind in matt Weiß oder Schwarz erhältlich. Die Länge der Abhängung beläuft sich auf 2000mm.

The simple and minimalist GILO PD pendant light made of with an opal acrylic diffuser boasts a timeless design. The powder-coated surface as well as the driver and ceiling canopy are available in matt white or black. The length of the suspension is 2000mm.



## GILO PD



ART. NR./CODE	LEISTUNG/POWER	LUMEN	CRI>	KELVIN	Ø x H	Abh./Susp.	FARBE/COLOUR	PREIS/PRICE
472-2429150	SYS 6W	340	90	3000	80 x 90	2000	white	179,00
472-2429160	SYS 6W	340	90	3000	80 x 90	2000	black	179,00







Mehr Flexibilität durch die magnetisch befestigten Strahlerköpfe.  
More flexibility thanks to the magnetically attached spotlight heads.



**MIMO T**



ART. NR./CODE	V DC USB ACCU	LUMEN	CRI>	KELVIN	Ø x H	FARBE/COLOUR	PREIS/PRICE
333-00001	2,2W	50	80	2700	30 x 358	anthracite	149,00
333-00002	2,2W	50	80	2700	30 x 358	sand	149,00



**MIMO F**



ART. NR./CODE	V DC USB ACCU	LUMEN	CRI>	KELVIN	Ø x H	FARBE/COLOUR	PREIS/PRICE
333-00003	2,2W	50	80	2700	30 x 1200	anthracite	199,00
333-00004	2,2W	50	80	2700	30 x 1200	sand	199,00

**MIMO DOUBLE F**



ART. NR./CODE	V DC USB ACCU	LUMEN	CRI>	KELVIN	Ø x H	FARBE/COLOUR	PREIS/PRICE
333-00005	2,2W	100	80	2700	30 x 1200	anthracite	249,00
333-00006	2,2W	100	80	2700	30 x 1200	sand	249,00



**MIMO** NEW



Unsere Akkuleuchte MIMO überzeugt neben dem ansprechendem Design auch durch angenehm warmweißes Licht (2700K). Dank des Schutzfaktors IP54 kann die Leuchte im Innen- aber auch im Außenbereich verwendet werden. Egal ob als Leseleuchte oder als Ergänzung für die Outdoor Lounge. Dank ihrem magnetisch befestigten und 360° schwenkbaren Leuchten-Kopf bietet MIMO volle Flexibilität.

In addition to its attractive design, our rechargeable MIMO light also impresses with its pleasant warm white light (2700K). Thanks to the IP54 protection factor, the light can be used both indoors and outdoors. Whether as a reading light or as an addition to the outdoor lounge. Thanks to its magnetically attached and 360° swivelling light head, MIMO offers complete flexibility.







Unsere EEDEN S T sorgt dank Tunable White (2700K bis 3000K), für eine angenehme Atmosphäre auf jedem Tisch. Sie ist in 4 Farben erhältlich und mit ihrem satinierten Leuchtenkopf ein echter Hingucker. Dank 8h Akkulaufzeit bei gleichbleibender Leuchtkraft ist sie bereit für stimmungsvolle Abende.

Thanks to tunable white (2700K to 3000K), our EEDEN S T creates a pleasant atmosphere on any table. It is available in 4 colours and is a real eye-catcher with its satined luminaire head. Thanks to its 8-hour battery life with constant luminosity, it is ready for atmospheric evenings.



### EEDEN S T

ART. NR./CODE	V DC USB ACCU	LUMEN	CRI>	KELVIN	Ø x H/Ø x H	FARBE/COLOUR	PREIS/PRICE
135-9006ss5t	3,7	120	80	2700/3000	126 x 369	green	129,00
135-9006su5t	3,7	120	80	2700/3000	126 x 369	rust brown	129,00
135-9006s65t	3,7	120	80	2700/3000	126 x 369	black	129,00
135-9006s95t	3,7	120	80	2700/3000	126 x 369	anthracite	129,00



### KERAMIKSCHIRM/CERAMIC SCREEN

ART. NR./CODE	FARBE/COLOUR	PREIS/PRICE
135-000100b0	seablue	79,00
135-000100f0	omeagreen	79,00
135-000100r0	bronze	79,00
135-000100s0	deer grey	109,00



Im Unterschied zur S Version bietet die M Version der EEDEN Tischleuchte eine noch höhere Akkulaufzeit von bis zu 11h bei 100% Leuchtkraft. Zudem ist sie in 3 Stufen dimmbar. Ihre Leuchtenköpfe sind zu je 3 Stück stapelbar, was eine einfache Lagerung und ein schnelles Aufladen über Nacht ermöglicht.

In comparison to the S version, the M version of the EEDEN table luminaire offers an even longer battery life of up to 11 hours at 100% luminosity. It is also dimmable in 3 levels. The lamp heads can be stacked in batches of 3, making them easy to store and quick to recharge overnight.

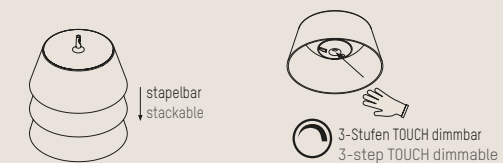

### EEDEN M T Version mit Standfuss/Version with stand

ART. NR./CODE	V DC USB ACCU	LUMEN	CRI>	KELVIN	Ø x H/Ø x H	FARBE/COLOUR	PREIS/PRICE
135-9002366t	3,7	140	80	2700	210 x 448	black	189,00
135-9002966t	3,7	140	80	3000	210 x 448	black	189,00

### EEDEN M T Version mit Tischklammer/Version with table clamp

135-9003366t	3,7	140	80	2700	210 x 448	black	189,00
135-9003966t	3,7	140	80	3000	210 x 448	black	189,00





Durch einen robusten Standfuß oder Erdspeiß aus Metall hält die EEDEN M F allen Einsatzmöglichkeiten stand. Wie auch bei der EEDEN M T machen die lange Akkulaufzeit von 11h und die stapelbaren Leuchtenköpfe sie zu einem praktischen Eyecatcher im In- und Outdoor Bereich.

Thanks to a robust metal base or ground spike, the EEDEN M F is ideal for any application. As with the EEDEN M T, the long battery life of 11 hours and the stackable lamp heads make it a practical eye-catcher for indoor and outdoor use.

**EEDEN M F 1** Version mit Standfuss/Version with stand



ART. NR./CODE	V DC USB ACCU	LUMEN	CRI>	KELVIN	Ø x H/Ø x H	FARBE/COLOUR	PREIS/PRICE
135-9004366t	3,7	140	80	2700	280 x 1300	black	229,00
135-9004966t	3,7	140	80	3000	280 x 1300	black	229,00

**EEDEN M F 2** Version mit Erdspeiß/Version with ground pike

135-9005366t	3,7	140	80	2700	210 x 1540	black	189,00
135-9005966t	3,7	140	80	3000	210 x 1540	black	189,00

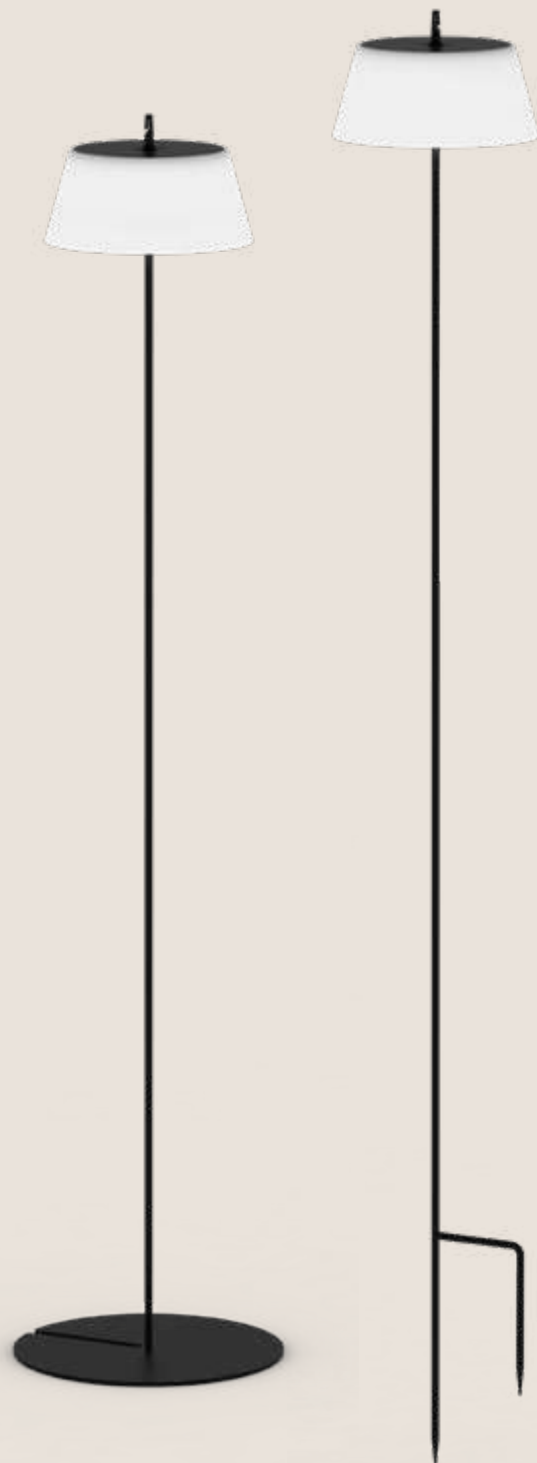
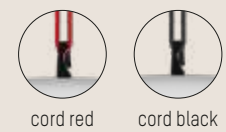
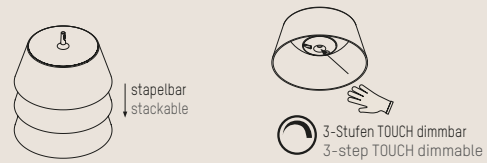

Die EEDEN Produktfamilie wird durch eine Pendelversion abgerundet. Dank dem, in Schwarz oder Rot erhältlichen, Abhängungsseil sind die individuellen Montage-Möglichkeiten nahezu endlos.

The EEDEN product family is rounded off by a pendant version. Thanks to a suspension cord, available in red or black, the individual mounting options are almost endless.

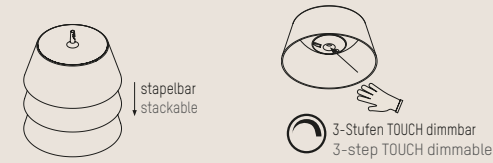

**EEDEN M PD**



ART. NR./CODE	V DC USB ACCU	LUMEN	CRI>	KELVIN	Ø x H/Ø x H	SEIL/CORD	FARBE/COLOUR	PREIS/PRICE
135-9001366t	3,7	140	80	2700	210 x 128	black	black	149,00
135-9001966t	3,7	140	80	3000	210 x 128	black	black	149,00
135-900136tt	3,7	140	80	2700	210 x 128	red	black	149,00
135-900196tt	3,7	140	80	3000	210 x 128	red	black	149,00





# TECNICO INDOOR





























































TECNICO INDOOR

DECKENEINBAULEUCHTEN  
CEILING RECESSED LUMINAIRES





# PRODUKTÜBERSICHT/INDEX

 <b>CHICCO ROUND R</b> S. 039/P. 039	 <b>IVY ROUND R</b> S. 039/P. 039	 <b>SUNRAY I/II/III/IV</b> S. 040/P. 040	 <b>SPEAKER 1/2</b> S. 042/P. 042	 <b>ENERGY 2130/2180/2245</b> S. 042/P. 042	 <b>AGON FLAT ROUND</b> S. 044/P. 044
 <b>AGON ROUND</b> S. 045/P. 045	 <b>SATOR</b> S. 046/P. 046	 <b>PONTOS ROUND</b> S. 046/P. 046	 <b>KALIO ROUND R</b> S. 047/P. 047	 <b>ELIX MINI R</b> S. 048/P. 048	 <b>ELIX R</b> S. 048/P. 048
 <b>SERIE 146 HV GU10</b> S. 050/P. 050	 <b>SERIE 223 HV GU10</b> S. 050/P. 050	 <b>SERIE 3380 HV GU10</b> S. 050/P. 050	 <b>SERIE 015 G4</b> S. 051/P. 051	 <b>SERIE 1101 HV GU10</b> S. 051/P. 051	 <b>WILLI 68R</b> S. 052/P. 052
 <b>SERIE 68 HV GU10</b> S. 054/P. 054	 <b>SERIE 332 HV GU10</b> S. 054/P. 054	 <b>QANA ROUND R</b> S. 054/P. 054	 <b>LIRO R</b> S. 058/P. 058	 <b>CHICCO SQUARE R</b> S. 060/P. 060	 <b>IVY SQUARE R</b> S. 060/P. 060
 <b>KALIO SQUARE R</b> S. 061/P. 061	 <b>AGON FLAT SQUARE</b> S. 062/P. 062	 <b>AGON SQUARE</b> S. 062/P. 062	 <b>SATOR SQUARE</b> S. 064/P. 064	 <b>PONTOS SQUARE</b> S. 064/P. 064	 <b>SERIE 4236 HV GU10</b> S. 066/P. 066
 <b>QANA SQUARE R</b> S. 066/P. 066	 <b>QANA DOUBLE SQUARE R</b> S. 066/P. 066	 <b>MOON ROUND R</b> S. 070/P. 070	 <b>MOON SQUARE R</b> S. 070/P. 070	 <b>MAAN SQUARE</b> S. 072/P. 072	 <b>MAAN ROUND</b> S. 072/P. 072
 <b>AEON ROUND SMALL</b> S. 080/P. 080	 <b>AEON ROUND BIG</b> S. 080/P. 080	 <b>AEON SQUARE SMALL</b> S. 082/P. 082	 <b>AEON SQUARE BIG</b> S. 082/P. 082	 <b>POLUS</b> S. 084/P. 084	 <b>UP AC</b> S. 084/P. 084
 <b>LIRO SD</b> S. 084/P. 084	 <b>CARMI</b> S. 086/P. 086	 <b>ARIK SHORT</b> S. 087/P. 087	 <b>DESCO M</b> S. 088/P. 088	 <b>DESCO L</b> S. 088/P. 088	 <b>MAG SDI</b> S. 090/P. 090
 <b>MAG SD TURN</b> S. 090/P. 090	 <b>MAGIS MINI SD</b> S. 092/P. 092	 <b>MAGIS MINI DOUBLE SD</b> S. 092/P. 092	 <b>MAGIS SD</b> S. 094/P. 094	 <b>MAGIS DOUBLE SD</b> S. 094/P. 094	 <b>MISSOR I</b> S. 098/P. 098
 <b>MISSOR II</b> S. 098/P. 098	 <b>MISSOR I SD GU10</b> S. 100/P. 100	 <b>MISSOR II SD GU10</b> S. 100/P. 100	 <b>MISSOR III SD GU10</b> S. 100/P. 100	 <b>QANA ROUND SD</b> S. 102/P. 102	 <b>QANA BOX 1 SD</b> S. 102/P. 102

# TECNICO INDOOR

 <b>QANA BOX 2 SD</b> S. 102/P. 102	 <b>MUSO ROUND SD</b> S. 106/P. 106	 <b>MUSO ROUND SD SENSOR</b> S. 106/P. 106	 <b>MUSO ROUND SD DALI</b> S. 106/P. 106	 <b>MUSO SQUARE SD</b> S. 108/P. 108	 <b>MUSO SQUARE SD SENSOR</b> S. 108/P. 108
 <b>MUSO LINEAR SD</b> S. 110/P. 110	 <b>MUSO 120 LINEAR CCT DALI</b> S. 110/P. 110	 <b>ALKOR 2 E27</b> S. 112/P. 112	 <b>APUS E27</b> S. 112/P. 112	 <b>ELSA E27</b> S. 112/P. 112	 <b>DELIA E27</b> S. 114/P. 114
 <b>DELIA</b> S. 114/P. 114	 <b>AURA E27</b> S. 116/P. 116	 <b>TITAN E27</b> S. 116/P. 116	 <b>LINA E27</b> S. 118/P. 118	 <b>TILIA E27</b> S. 118/P. 118	 <b>ISIS E27</b> S. 120/P. 120
 <b>FORO SHORT PD</b> S. 124/P. 124	 <b>FORO LONG PD</b> S. 124/P. 124	 <b>NOVEL</b> S. 126/P. 126	 <b>ALICA</b> S. 126/P. 126	 <b>BO SINGLE</b> S. 128/P. 128	 <b>BO DOUBLE</b> S. 128/P. 128
 <b>TAKE 69</b> S. 128/P. 128	 <b>AROK</b> S. 130/P. 130	 <b>CLARUS</b> S. 131/P. 131	 <b>SERIE 44 SHORT SD</b> S. 132/P. 132	 <b>SERIE 44 LONG SD</b> S. 132/P. 132	 <b>MATAR</b> S. 132/P. 132
 <b>LANU ROUND W</b> S. 134/P. 134	 <b>LANU FLAT W</b> S. 135/P. 135	 <b>MOTUS LONG W</b> S. 136/P. 136	 <b>ZHOOM W</b> S. 136/P. 136	 <b>WALL 68R</b> S. 140/P. 140	 <b>WALL 68R IP44</b> S. 142/P. 142
 <b>WINDOW I</b> S. 144/P. 144	 <b>PAN</b> S. 144/P. 144	 <b>WINDOW II</b> S. 145/P. 145	 <b>3-PHASE TRACK</b> S. 148/P. 148	 <b>3-PHASE TRACK DALI</b> S. 150/P. 150	 <b>MOOVE TRACK</b> S. 154/P. 154
 <b>TRACK SET MOOVE</b> S. 158/P. 158	 <b>TRACK SET MAG</b> S. 159/P. 159	 <b>SHOPSTAR LEAN TRACK</b> S. 154/P. 154	 <b>MAG TRACK</b> S. 156/P. 156	 <b>MAGIS TRACK</b> S. 156/P. 156	
 <b>RETRO 595R</b> S. 162/P. 162	 <b>RETRO 620R</b> S. 162/P. 162	 <b>RETRO 1230R</b> S. 162/P. 162	 <b>FIT</b> S. 164/P. 164	 <b>FIT LONG</b> S. 164/P. 164	 <b>RUBE PDI</b> S. 166/P. 166



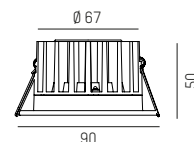

Einbaustrahler, Aluminiumdruckguss, Feinstruktur matt pulverbeschichtet, starr, zurückversetzte Lichtquelle, exkl. Konverter

Recessed spotlight, die-cast aluminium, powder-coated, fixed, recessed light source, excl. driver

### CHICCO ROUND R



ART. NR./CODE	LEISTUNG/POWER	mA	LUMEN	CRI>	KELVIN	Ø x ET/Ø x ID	⊙	FARBE/COLOUR	REFL.	PREIS/PRICE
308-0010790302704	LED 7W	350	530	90	2700	90 x 80	78	silver	30°	54,00
308-0010790302705	LED 7W	350	540	90	2700	90 x 80	78	white	30°	54,00
308-0010790302706	LED 7W	350	510	90	2700	90 x 80	78	black	30°	54,00
308-0010790303004	LED 7W	350	560	90	3000	90 x 80	78	silver	30°	54,00
308-0010790303005	LED 7W	350	590	90	3000	90 x 80	78	white	30°	54,00
308-0010790303006	LED 7W	350	560	90	3000	90 x 80	78	black	30°	54,00



### KONVERTER/DRIVER



ART. NR./CODE	INFO	WATT	mA	V DC	V AC	L x B x H/L x W x H	FARBE/COLOUR	PREIS/PRICE
30-880006	on/off	15W	350	44	230	156 x 43 x 30	white	13,00
24-151403	DALI	17W	350	49	230	111 x 52 x 22	white	57,20

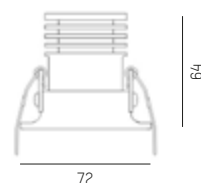

Einbaustrahler, Aluminiumdruckguss, Feinstruktur matt pulverbeschichtet, starr, zurückversetzte Lichtquelle, exkl. Konverter

Recessed spotlight, die-cast aluminium, powder-coated, fixed, with recessed light source, 2 beam angles, excl. driver

### IVY ROUND R



ART. NR./CODE	LEISTUNG/POWER	mA	LUMEN	CRI>	KELVIN	Ø x ET/Ø x ID	⊙	FARBE/COLOUR	REFL.	PREIS/PRICE
472-0260790203005	LED 7W	200	700	90	3000	72 x 94	60	white	20°	59,00
472-0260790203006	LED 7W	200	660	90	3000	72 x 94	60	black	20°	59,00
472-0260790403005	LED 7W	200	640	90	3000	72 x 94	60	white	40°	59,00
472-0260790403006	LED 7W	200	630	90	3000	72 x 94	60	black	40°	59,00



### KONVERTER/DRIVER



ART. NR./CODE	INFO	WATT	mA	V DC	V AC	L x B x H/L x W x H	FARBE/COLOUR	PREIS/PRICE
30-880006	on/off	8,5W	200	44	230	156 x 43 x 30	white	13,00
24-151395	DALI	9W	180	50	230	108 x 52 x 22	white	58,20





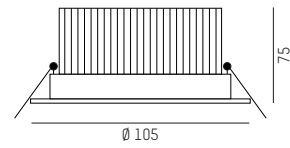

Einbaustrahler, Aluminium-druckguss, Feinstruktur matt pulverbeschichtet, passiv gekühlt, starr, Schutzglas, exkl. Konverter

Recessed spotlight, die-cast aluminium, fine structure matt powder-coated, passively cooled, rigid, protective glass, excl. converter



**SUNRAY I**

ART. NR./CODE	UGR<19		CRI>	KELVIN	Ø x ET/Ø x ID	Ⓢ	FARBE/COLOUR	REFL.	PREIS/PRICE
	LUMEN/W BEI 250mA LUMEN/W WITH 250mA	LUMEN/W BEI 350mA LUMEN/W WITH 350mA							
	<b>LED 10W</b>	<b>LED 14W</b>							
8-09519455	1000	1400	80	3000	105 x 105	95	white	36°	49,00
8-09514455	1050	1500	80	4000	105 x 105	95	white	36°	49,00

KONVERTER SEPARAT ORDERN/ORDER DRIVER SEPARATELY									
	30-880006	30-880106	on/off					13,00	14,00
	24-151403	24-151403	DALI					57,20	57,20

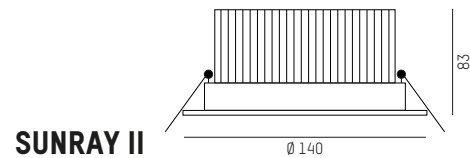

**SUNRAY II**

ART. NR./CODE	UGR<19			CRI>	KELVIN	Ø x ET/Ø x ID	Ⓢ	FARBE/COLOUR	REFL.	PREIS/PRICE
	LUMEN/W BEI 350mA LUMEN/W WITH 350mA	LUMEN/W BEI 500mA LUMEN/W WITH 500mA	LUMEN/W BEI 700mA LUMEN/W WITH 700mA							
	<b>LED 14W</b>	<b>LED 20W</b>	<b>LED 28W</b>							
8-12519455	1450	1950	2750	80	3000	140 x 113	125	white	45°	69,00
8-12514455	1550	2100	2900	80	4000	140 x 113	125	white	45°	69,00

KONVERTER SEPARAT ORDERN/ORDER DRIVER SEPARATELY										
	30-880106	30-880106	30-880106	on/off				14,00	14,00	14,00
	24-151403	24-127490	24-127490	DALI				57,20	67,80	67,80

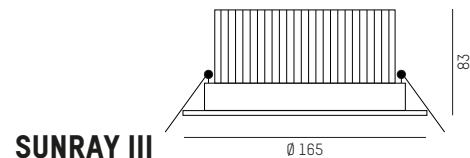

**SUNRAY III**

ART. NR./CODE	UGR<19			CRI>	KELVIN	Ø x ET/Ø x ID	Ⓢ	FARBE/COLOUR	REFL.	PREIS/PRICE
	LUMEN/W BEI 350mA LUMEN/W WITH 350mA	LUMEN/W BEI 500mA LUMEN/W WITH 500mA	LUMEN/W BEI 700mA LUMEN/W WITH 700mA							
	<b>LED 14W</b>	<b>LED 20W</b>	<b>LED 28W</b>							
8-15019455	1650	2250	2850	80	3000	165 x 113	150	white	45°	89,00
8-15014455	1750	2400	3000	80	4000	165 x 113	150	white	45°	89,00

KONVERTER SEPARAT ORDERN/ORDER DRIVER SEPARATELY										
	30-880106	30-880106	30-880106	on/off				14,00	14,00	14,00
	24-151403	24-127490	24-127490	DALI				57,20	67,80	67,80

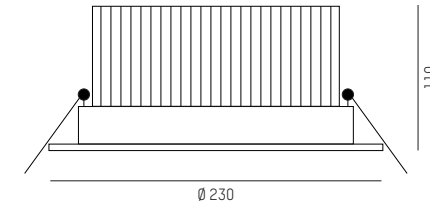

**SUNRAY IV**

ART. NR./CODE	UGR<19			CRI>	KELVIN	Ø x ET/Ø x ID	Ⓢ	FARBE/COLOUR	REFL.	PREIS/PRICE
	LUMEN/W BEI 500mA LUMEN/W WITH 500mA	LUMEN/W BEI 700mA LUMEN/W WITH 700mA	LUMEN/W BEI 1050mA LUMEN/W WITH 1050mA							
	<b>LED 21W</b>	<b>LED 29W</b>	<b>LED 43W</b>							
8-20519505	2300	3050	4150	80	3000	230 x 140	205	white	50°	119,00
8-20514505	2400	3150	4300	80	4000	230 x 140	205	white	50°	119,00

KONVERTER SEPARAT ORDERN/ORDER DRIVER SEPARATELY										
	30-880106	30-880106	24-122204	on/off				14,00	14,00	60,40
	24-127490	24-127490	24-15141350	DALI				67,80	67,80	71,00



Projekt: Kurhotel Marienkron, Mönchhof, Österreich, Planung und Umsetzung: Mayr & Glatzl, Foto: Gabriel Büchelmeier, Produkt: SUNRAY II



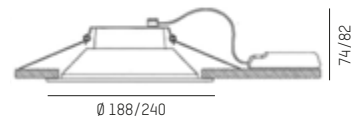

Einbaustrahler, Aluminiumblech tiefgezogen, einstellbare Stahlbügel, Diffusor Polycarbonat, inkl. Konverter, sichtbare Teile IP44, nicht sichtbare Teile IP20

Recessed spotlight, deep-drawn sheet aluminium, adjustable steel bracket, polycarbonate diffuser, incl. converter, visible parts IP44, non-visible parts IP20

NEW

## SPEAKER 1/SPEAKER 2

ART. NR./CODE	LEISTUNG/POWER	LUMEN	CRI>	KELVIN	Ø x ET/Ø x ID	⊙	FARBE/COLOUR	REFL.	PREIS/PRICE
121-2208441000	SYS 14W	1200	80	3000	188 x 104	154-182	white	100°	39,00
121-2208441100	SYS 14W	1300	80	4000	188 x 104	154-182	white	100°	39,00
121-2208441500	SYS 25W	1900	80	3000	230 x 112	192-224	white	100°	44,00
121-2208441600	SYS 25W	2000	80	4000	230 x 112	192-224	white	100°	44,00

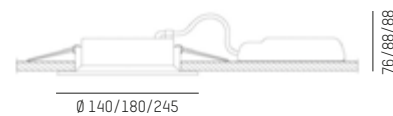

Einbaustrahler, Aluminiumdruckguss, starr, Diffusor aus Polycarbonat, inkl. Konverter, sichtbare Teile IP44, nicht sichtbare Teile IP20

Recessed spotlight, die-cast aluminium, rigid, polycarbonate diffuser, incl. converter, visible parts IP44, non-visible parts IP20

NEW

## ENERGY 2130 / 2180 / 2245

ART. NR./CODE	LEISTUNG/POWER	LUMEN	CRI>	KELVIN	Ø x ET/Ø x ID	⊙	FARBE/COLOUR	REFL.	PREIS/PRICE
121-2217231439	SYS 7/10/11W	797/1106/1252	90	3000	140 x 76	110-135	white	100°	49,00
121-2217231400	SYS 7/10/11W	839/1164/1317	90	4000	140 x 76	110-135	white	100°	49,00
121-2217251539	SYS 9/13/14/19W	1097/1536/1702/2135	90	3000	180 x 88	160-175	white	100°	69,00
121-2217251500	SYS 9/13/14/19W	1147/1607/1830/2247	90	4000	180 x 88	160-175	white	100°	69,00
121-2217220139	SYS 14/18/19/20/22/25/26W	1845/2266/2379/2503/2729/3175/3289	90	3000	245 x 88	200-240	white	100°	79,00
121-2217220100	SYS 14/18/19/20/22/25/26W	1926/2385/2503/2626/2884/3342/3461	90	4000	245 x 88	200-240	white	100°	79,00





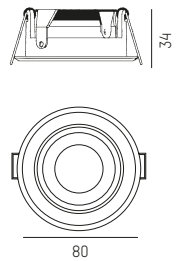

Einbaustrahler Aluminiumdruckguss, 2700 oder 3000K

Recessed spotlight die-cast aluminium, 2700 or 3000K switchable

NEW

**AGON FLAT ROUND**

ART. NR./CODE	LEISTUNG/POWER	mA	LUMEN	CRI>	KELVIN	Ø x ET/Ø x ID	⊙	FARBE/COLOUR	REFL.	PREIS/PRICE
222-00128	LED 5W	250	650	90	2700	80 x 64	68	white	55°	39,00
222-00129	LED 5W	250	650	90	2700	80 x 64	68	black	55°	39,00
222-00130	LED 5W	250	650	90	3000	80 x 64	68	white	55°	39,00
222-00131	LED 5W	250	650	90	3000	80 x 64	68	black	55°	39,00

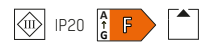

**KONVERTER/DRIVER**

ART. NR./CODE	INFO	WATT	mA	V DC	V AC	L x B x H/L x W x H	FARBE/COLOUR	PREIS/PRICE
30-880006	on/off	11W	250	44	230	156 x 43 x 30	white	13,00
24-151403	DALI	12W	250	49	230	111 x 52 x 22	white	57,20

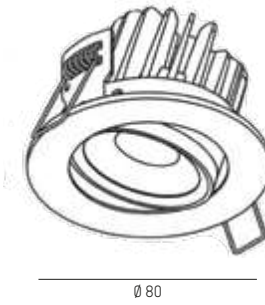

Einbaustrahler, Aluminiumdruckguss, gebürstet oder pulverbeschichtet, exkl. Konverter

spotlight, die-cast aluminium, brushed or powder-coated, excl. converter

NEW

**AGON ROUND**

ART. NR./CODE	LEISTUNG/POWER	mA	LUMEN	CRI>	KELVIN	Ø x ET/Ø x ID	⊙	FARBE/COLOUR	REFL.	PREIS/PRICE
222-00136	LED 6/11W	250/500	415/705	90	2700	80 x 84	68	white	36°	49,00
222-00137	LED 6/11W	250/500	415/705	90	2700	80 x 84	68	black	36°	49,00
222-00138	LED 6/11W	250/500	475/830	90	3000	80 x 84	68	white	36°	49,00
222-00139	LED 6/11W	250/500	475/830	90	3000	80 x 84	68	black	36°	49,00



**KONVERTER/DRIVER**

ART. NR./CODE	INFO	WATT	mA	V DC	V AC	L x B x H/L x W x H	FARBE/COLOUR	PREIS/PRICE
30-880006	on/off	11W/18,5W	250/500	44	230	156 x 43 x 30	white	13,00
24-151403	DALI	12W/20W	250/500	49	230	111 x 52 x 22	white	57,20





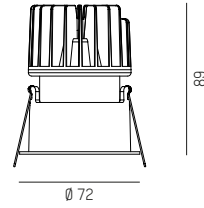

Einbaustrahler, Aluminiumdruckguss, Feinstruktur matt pulverbeschichtet, zurückversetzte Lichtquelle, exkl. Konverter

spotlight, die-cast aluminium, fine structure, matt powder-coated, recessed light source, excl. converter



**SATOR**

ART. NR./CODE	LEISTUNG/POWER	mA	LUMEN	CRI>	KELVIN	Ø x ET/Ø x ID	Ⓢ	FARBE/COLOUR	REFL.	PREIS/PRICE
305-30013500	LED 10W	250	600	90	2700	72 x 119	68	white	24°	49,00
305-30013600	LED 10W	250	600	90	2700	72 x 119	68	black	24°	49,00
305-30019500	LED 10W	250	620	90	3000	72 x 119	68	white	24°	49,00
305-30019600	LED 10W	250	620	90	3000	72 x 119	68	black	24°	49,00

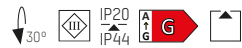

**KONVERTER/DRIVER**

ART. NR./CODE	INFO	WATT	mA	V DC	V AC	L x B x H/L x W x H	FARBE/COLOUR	PREIS/PRICE
30-880006	on/off	11W	250	44	230	156 x 43 x 30	white	13,00
24-151403	DALI	12W	250	49	230	111 x 52 x 22	white	57,20



Einbaustrahler, Aluminiumdruckguss, pulverbeschichtet, zurückversetzte Lichtquelle, exkl. Konverter

Recessed spotlight, die-cast aluminium, powder-coated, recessed light source, excl. converter



**PONTOS ROUND**

ART. NR./CODE	LUMEN/W BEI 250mA LUMEN/W WITH 250mA		LUMEN/W BEI 350mA LUMEN/W WITH 350mA		CRI>	KELVIN	Ø x ET/Ø x ID	Ⓢ	FARBE/COLOUR	REFL.	PREIS/PRICE
	LED 10W	LED 15W	LED 10W	LED 15W							
305-619924w27k	805	1245	80	2700	90 x 110	83	white	24°	74,00		
305-619924b27k	805	1245	80	2700	90 x 110	83	black	24°	74,00		
305-619924w	840	1280	80	3000	90 x 110	83	white	24°	74,00		
305-619924b	840	1280	80	3000	90 x 110	83	black	24°	74,00		
305-619924w40k	840	1280	80	4000	90 x 110	83	white	24°	74,00		
305-619924b40k	840	1280	80	4000	90 x 110	83	black	24°	74,00		
305-619936w27k	805	1245	80	2700	90 x 110	83	white	36°	74,00		
305-619936b27k	805	1245	80	2700	90 x 110	83	black	36°	74,00		
305-619936w	840	1280	80	3000	90 x 110	83	white	36°	74,00		
305-619936b	840	1280	80	3000	90 x 110	83	black	36°	74,00		
305-619936w40k	840	1280	80	4000	90 x 110	83	white	36°	74,00		
305-619936b40k	840	1280	80	4000	90 x 110	83	black	36°	74,00		



**KONVERTER/DRIVER**

ART. NR./CODE	INFO	WATT	mA	V DC	V AC	L x B x H/L x W x H	FARBE/COLOUR	PREIS/PRICE
30-880006	on/off	11W/15W	250/350	44	230	156 x 43 x 30	white	13,00
24-151403	DALI	12W/17W	250/350	49	230	111 x 52 x 22	white	57,20

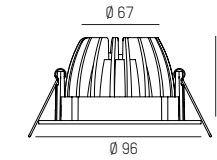

Einbaustrahler, Aluminiumdruckguss, Feinstruktur matt pulverbeschichtet, zurückversetzte Lichtquelle, exkl. Konverter

Recessed spotlight, die-cast aluminium, fine structure matt powder-coated, recessed light source, excl. light source, excl. converter



**KALIO ROUND R**

ART. NR./CODE	LEISTUNG/POWER	mA	LUMEN	CRI>	KELVIN	Ø x ET/Ø x ID	Ⓢ	FARBE/COLOUR	REFL.	PREIS/PRICE
308-30003500	LED 8W	250	860	90	2700	96 x 83	80	white	24°	34,00
308-30003600	LED 8W	250	860	90	2700	96 x 83	80	black	24°	34,00
308-30013500	LED 8W	250	860	90	2700	96 x 83	80	white	38°	34,00
308-30013600	LED 8W	250	860	90	2700	96 x 83	80	black	38°	34,00
308-30009500	LED 8W	250	900	90	3000	96 x 83	80	white	24°	34,00
308-30009600	LED 8W	250	900	90	3000	96 x 83	80	black	24°	34,00
308-30019500	LED 8W	250	900	90	3000	96 x 83	80	white	38°	34,00
308-30019600	LED 8W	250	900	90	3000	96 x 83	80	black	38°	34,00



**KONVERTER/DRIVER**

ART. NR./CODE	INFO	WATT	mA	V DC	V AC	L x B x H/L x W x H	FARBE/COLOUR	PREIS/PRICE
30-880006	on/off	11W	250	44	230	156 x 43 x 30	white	13,00
24-151403	DALI	12W	250	49	230	111 x 52 x 22	white	57,20





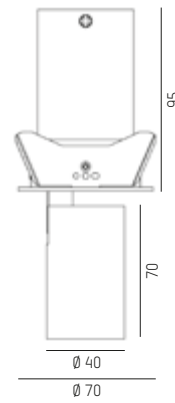

Einbaustrahler, Aluminiumdruckguss, Feinstruktur matt pulverbeschichtet, Dekorring aus Kunststoff, Strahlerkopf 90° schwenk- und 350° (35° ELIX) drehbar, exkl. Konverter

Recessed spotlight, die-cast aluminium, fine structure matt powder-coated, Decorative ring made of plastic, spotlight head 90° swivelling and 350° (35° ELIX) rotatable, excl. converter



**ELIX MINI R**

ART. NR./CODE	LEISTUNG/POWER	mA	LUMEN	CRI>	KELVIN	Ø x ET/Ø x ID	Ⓢ	FARBE/COLOUR	REFL.	PREIS/PRICE
276-0130690342756	LED 6W	350	330	90	2700	70 x 125	64	white	34°	99,00
276-0130690342706	LED 6W	350	330	90	2700	70 x 125	64	black	34°	99,00
276-0130690343056	LED 6W	350	340	90	3000	70 x 125	64	white	34°	99,00
276-0130690343006	LED 6W	350	340	90	3000	70 x 125	64	black	34°	99,00



**ELIX MINI R DEKORRING/DECORATION RING**

ART. NR./CODE	INFO	Ø	FARBE/COLOUR	PREIS/PRICE
276-7002	Ring aus Kunststoff, gold oder weiß, werkzeuglos wechselbar (separat ordern)	38	gold	5,30
276-7003	Synthetic decoration ring, gold or white, changeable without tools (order separately)	38	white	5,30

**KONVERTER/DRIVER**

ART. NR./CODE	INFO	WATT	mA	V DC	V AC	L x B x H/L x W x H	FARBE/COLOUR	PREIS/PRICE
30-880006	on/off	15W	350	44	230	156 x 43 x 30	white	13,00
24-151403	DALI	17W	350	49	230	111 x 52 x 22	white	57,20



Dekorring  
Decoration ring

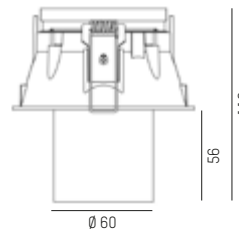

**ELIX R**

ART. NR./CODE	LEISTUNG/POWER	mA	LUMEN	CRI>	KELVIN	Ø x ET/Ø x ID	Ⓢ	FARBE/COLOUR	REFL.	PREIS/PRICE
276-0010990332756	LED 9W	500	650	90	2700	110 x 91	102	white	33°	119,00
276-0010990332706	LED 9W	500	650	90	2700	110 x 91	102	black	33°	119,00
276-0010990333056	LED 9W	500	770	90	3000	110 x 91	102	white	33°	119,00
276-0010990333006	LED 9W	500	770	90	3000	110 x 91	102	black	33°	119,00



**KONVERTER/DRIVER**

ART. NR./CODE	INFO	WATT	mA	V DC	V AC	L x B x H/L x W x H	FARBE/COLOUR	PREIS/PRICE
30-880006	on/off	18,5W	500	44	230	156 x 43 x 30	white	13,00
24-151403	DALI	20W	500	49	230	111 x 52 x 22	white	57,20

**ELIX R DEKORRING/DECORATION RING**



ART. NR./CODE	INFORMATION	FARBE/COLOUR	PREIS/PRICE
276-7000	Ring aus Kunststoff, gold, weiß oder schwarz werkzeuglos wechselbar (separat ordern) Synthetic decoration ring, gold, white or black, changeable without tools (order separately)	gold	6,90
276-7001		white	6,90
222-A00021		black	6,90

**ELIX R WABENRASTER/HONEY COMP LOUVRE**



ART. NR./CODE	INFO	Ø	FARBE/COLOUR	PREIS/PRICE
276-1002	Wabenraster aus Metall, werkzeuglos wechselbar. (separat ordern) Honey Comp Louvre, changeable without tools, order separately	58	black	4,80



Projekt: Freiraum Freistadt, Österreich, Planung & Umsetzung: Ben Elmecker, Foto: Martin Pröll, Produkt: ELIX MINI



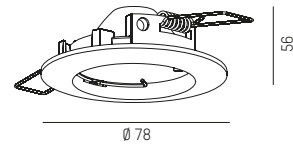

Einbaustrahler, Aluminiumdruckguss, pulverbeschichtet oder galvanisiert, starr, inkl. 30cm Kabel

Recessed spotlight, die-cast aluminium, powder-coated or galvanized, incl. 30cm cable



### SERIE 146 HV GU10

ART. NR./CODE	LM/BULB	FASSUNG/SOCKET	V AC	Ø x ET/Ø x ID	Ⓢ	FARBE/COLOUR	REFL.	PREIS/PRICE
8-1464hv	RETROFIT	GU10	230	77 x 113	65	chrome	---	9,00
8-1466hv	RETROFIT	GU10	230	77 x 113	65	black	---	8,00
8-1467hv	RETROFIT	GU10	230	77 x 113	65	white	---	8,00
8-14646hv	RETROFIT	GU10	230	77 x 113	65	brushed nickel	---	9,00

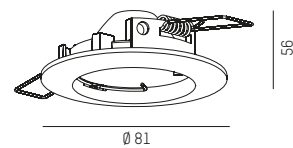

Einbaustrahler, Aluminiumdruckguss, pulverbeschichtet oder galvanisiert, starr, inkl. 30cm Kabel

Recessed spotlight, die-cast aluminium, powder-coated or galvanized, incl. 30cm cable



### SERIE 223 HV GU10

ART. NR./CODE	LM/BULB	FASSUNG/SOCKET	V AC	Ø x ET/Ø x ID	Ⓢ	FARBE/COLOUR	REFL.	PREIS/PRICE
8-2237hv	RETROFIT	GU10	230	81 x 135	68	white	---	10,00
8-22346hv	RETROFIT	GU10	230	81 x 135	68	brushed nickel	---	12,00
8-2235hv	RETROFIT	GU10	230	81 x 135	68	black	---	10,00

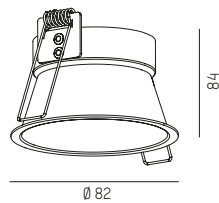
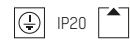

Einbaustrahler, Aluminiumdruckguss, pulverbeschichtet oder galvanisiert, starr, inkl. 30cm Kabel

Recessed spotlight, die-cast aluminium, powder-coated or galvanized, incl. 30cm cable



### SERIE 3380 HV GU10

ART. NR./CODE	LM/BULB	FASSUNG/SOCKET	V AC	Ø x ET/Ø x ID	Ⓢ	FARBE/COLOUR	REFL.	PREIS/PRICE
8-33806hv	RETROFIT	GU10	230	81 x 157	75	black	---	14,00
8-33807hv	RETROFIT	GU10	230	81 x 157	75	white	---	14,00



### LEUCHTMITTEL/LIGHT SOURCE

Weitere Leuchtmittel S./additional light sources P. 290

ART. NR./CODE	INFORMATION	PREIS/PRICE
30-752517	Core Pro LED Spot, GU10,5W, 827 Kelvin	6,50
30-767655	Core Pro LED Capsule, G4,2W, 827 Kelvin	10,30

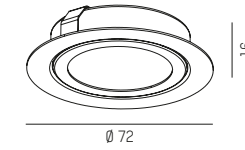

Einbaustrahler, Stahlblech, pulverbeschichtet oder galvanisiert, starr, Schutzglas matt, 1m Silikonkabel exkl. Trafo

Recessed spotlight, sheet steel, powder-coated or galvanized, fixed, protection glass matt, 1m silicone cable, excl. driver



### SERIE 015 G4

ART. NR./CODE	LM/BULB	FASSUNG/SOCKET	V AC	Ø x ET/Ø x ID	Ⓢ	FARBE/COLOUR	REFL.	PREIS/PRICE
8-0154	RETROFIT	G4	230	70 x 40	55	chrome	---	11,00
8-0157	RETROFIT	G4	230	70 x 40	55	white	---	10,00
8-01546	RETROFIT	G4	230	70 x 40	55	brushed nickel	---	11,00
8-0156	RETROFIT	G4	230	70 x 40	55	black	---	10,00

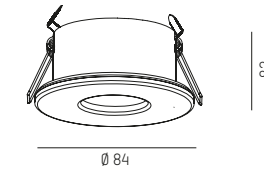

Einbaustrahler, Aluminiumdruckguss, pulverbeschichtet oder galvanisiert, starr, Schutzglas

Recessed spotlight, die-cast aluminium, powder-coated or galvanized, protection glass



### SERIE 1101 HV GU10

ART. NR./CODE	LM/BULB	FASSUNG/SOCKET	V AC	Ø x ET/Ø x ID	Ⓢ	FARBE/COLOUR	REFL.	PREIS/PRICE
8-1101b6hv	RETROFIT	GU10	230	84 x 120	74	black	---	19,00
8-1101b7hv	RETROFIT	GU10	230	84 x 120	74	white	---	19,00
8-1101b46hv	RETROFIT	GU10	230	84 x 120	74	brushed nickel	---	21,00







Deckeneinbauleuchte, aus Aluminium, Lichtaustritt direkt, E27 Fassung

Recessed ceiling light, made of aluminium, light emission direct, E27 socket

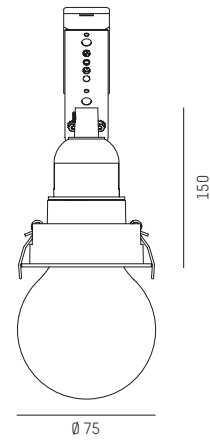

NEW

**WILLI 68R**



ART. NR./CODE	LM/BULB	FASSUNG/SOCKET	V AC	Ø x ET/Ø x ID	Ⓢ	FARBE/COLOUR	PREIS/PRICE
222-00027	RETROFIT	E27	230	75 x 160	68	white	34,00
222-00028	RETROFIT	E27	230	75 x 160	68	black	34,00

IP20

**LEUCHTMITTEL/LIGHT SOURCE**

Weitere Leuchtmittel S./additional light sources P. 290

ART. NR./CODE	INFORMATION	PREIS/PRICE
30-380035	E27/A60/7W/827	4,90





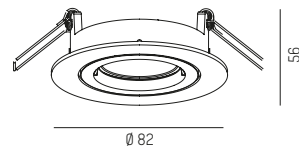

Einbaustrahler, Aluminiumdruckguss, pulverbeschichtet oder galvanisiert, inkl. 30cm Kabel

Recessed spotlight, die-cast aluminium, white or black powder-coated or galvanized, incl. 30cm cable

### SERIE 68 HV GU10

ART. NR./CODE	LM/BULB	FASSUNG/SOCKET	V AC	Ø x ET/Ø x ID	⊙	FARBE/COLOUR	REFL.	PREIS/PRICE
8-681hv	RETROFIT	GU10	230	82 x 110	70	brass polished	---	14,00
8-684hv	RETROFIT	GU10	230	82 x 110	70	chrome	---	14,00
8-686hv	RETROFIT	GU10	230	82 x 110	70	black	---	11,00
8-687hv	RETROFIT	GU10	230	82 x 110	70	white	---	11,00
8-6846hv	RETROFIT	GU10	230	82 x 110	70	brushed nickel	---	14,00

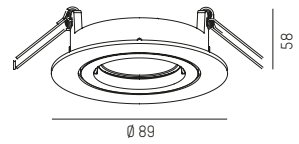

Einbaustrahler, Aluminiumdruckguss, pulverbeschichtet oder galvanisiert, inkl. 30cm Kabel mit Bajonettverschluss

Recessed spotlight, die-cast aluminium, white or black powder-coated or galvanized, incl. 30cm cable, with bayonet closure

### SERIE 332 HV GU10

ART. NR./CODE	LM/BULB	FASSUNG/SOCKET	V AC	Ø x ET/Ø x ID	⊙	FARBE/COLOUR	REFL.	PREIS/PRICE
8-3321hv	RETROFIT	GU10	230	89 x 125	68	brass polished	---	17,00
8-3324hv	RETROFIT	GU10	230	89 x 125	68	chrome	---	17,00
8-3326hv	RETROFIT	GU10	230	89 x 125	68	black	---	14,00
8-3327hv	RETROFIT	GU10	230	89 x 125	68	white	---	14,00
8-33246hv	RETROFIT	GU10	230	89 x 125	68	brushed nickel	---	17,00

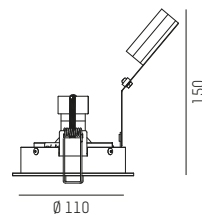

Einbaustrahler, Aluminiumdruckguss, pulverbeschichtet

Recessed spotlight, die-cast aluminium, powder-coated

NEW

### QANA ROUND R

ART. NR./CODE	LM/BULB	FASSUNG/SOCKET	V AC	Ø x ET/Ø x ID	⊙	FARBE/COLOUR	REFL.	PREIS/PRICE
222-00015	RETROFIT	GU10	230	110 x 180	98	white	---	45,00
222-00016	RETROFIT	GU10	230	110 x 180	98	black	---	45,00



### LEUCHTMITTEL/LIGHT SOURCE

Weitere Leuchtmittel S./additional light sources P. 290

ART. NR./CODE	INFORMATION	PREIS/PRICE
30-752517	Core Pro LED Spot, GU10,5W, 827 Kelvin	6,50









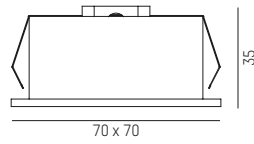

Einbaustrahler, Aluminiumdruckguss, Feinstruktur matt pulverbeschichtet, starr, zurückversetzte Lichtquelle, exkl. Konverter

Recessed spotlight, die-cast aluminium, powder-coated, fixed, with recessed light source, excl. driver



## LIRO R

ART. NR./CODE	LEISTUNG/POWER	mA	LUMEN	CRI>	KELVIN	L x B x ET/L x W x ID	Ø	FARBE/COLOUR	REFL.	PREIS/PRICE
472-30003560	LED 6W	500	460	90	2700	70 x 70 x 65	62 x 62	white/black	10°	69,00
472-30003660	LED 6W	500	460	90	2700	70 x 70 x 65	62 x 62	black	10°	69,00
472-30013560	LED 6W	500	460	90	2700	70 x 70 x 65	62 x 62	white/black	30°	69,00
472-30013660	LED 6W	500	460	90	2700	70 x 70 x 65	62 x 62	black	30°	69,00
472-30009560	LED 6W	500	500	90	3000	70 x 70 x 65	62 x 62	white/black	10°	69,00
472-30009660	LED 6W	500	500	90	3000	70 x 70 x 65	62 x 62	black	10°	69,00
472-30019560	LED 6W	500	500	90	3000	70 x 70 x 65	62 x 62	white/black	30°	69,00
472-30019660	LED 6W	500	500	90	3000	70 x 70 x 65	62 x 62	black	30°	69,00



## KONVERTER/DRIVER



ART. NR./CODE	INFO	WATT	mA	V DC	V AC	L x B x H/L x W x H	FARBE/COLOUR	PREIS/PRICE
30-880006	on/off	18,5W	500	37	230	156 x 43 x 30	white	13,00
24-151403	DALI	20W	500	49	230	111 x 52 x 22	white	57,20





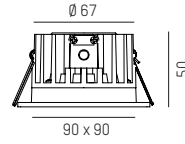

Einbaustrahler, Aluminiumdruckguss, Feinstruktur matt pulverbeschichtet, zurückversetzte Lichtquelle, exkl. Konverter

Recessed spotlight, die-cast aluminium, powder-coated, recessed light source, excl. driver

### CHICCO SQUARE R

ART. NR./CODE	LEISTUNG/POWER	mA	LUMEN	CRI>	KELVIN	L x B x ET/L x W x ID	⊙	FARBE/COLOUR	REFL.	PREIS/PRICE
308-0020790302704	LED 7W	350	530	90	2700	90 x 90 x 80	78	silver	30°	54,00
308-0020790302705	LED 7W	350	540	90	2700	90 x 90 x 80	78	white	30°	54,00
308-0020790302706	LED 7W	350	510	90	2700	90 x 90 x 80	78	black	30°	54,00
308-0020790303004	LED 7W	350	560	90	3000	90 x 90 x 80	78	silver	30°	54,00
308-0020790303005	LED 7W	350	590	90	3000	90 x 90 x 80	78	white	30°	54,00
308-0020790303006	LED 7W	350	560	90	3000	90 x 90 x 80	78	black	30°	54,00

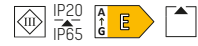

### KONVERTER/DRIVER



ART. NR./CODE	INFO	WATT	mA	V DC	V AC	L x B x H/L x W x H	FARBE/COLOUR	PREIS/PRICE
30-880006	on/off	15W	350	44	230	156 x 43 x 30	white	13,00
24-151403	DALI	17W	350	49	230	111 x 52 x 22	white	57,20

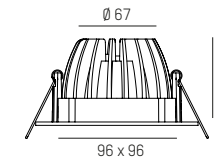

Einbaustrahler, Aluminiumdruckguss, Feinstruktur matt pulverbeschichtet, zurückversetzte Lichtquelle, exkl. Konverter

Recessed spotlight, die-cast aluminium, powder-coated, with recessed light source, excl. driver

### KALIO SQUARE R

ART. NR./CODE	LEISTUNG/POWER	mA	LUMEN	CRI>	KELVIN	L x B x ET/L x W x ID	⊙	FARBE/COLOUR	REFL.	PREIS/PRICE
308-30023500	LED 8W	250	860	90	2700	96 x 96 x 83	80	white	24°	34,00
308-30023600	LED 8W	250	860	90	2700	96 x 96 x 83	80	black	24°	34,00
308-30033500	LED 8W	250	860	90	2700	96 x 96 x 83	80	white	38°	34,00
308-30033600	LED 8W	250	860	90	2700	96 x 96 x 83	80	black	38°	34,00
308-30029500	LED 8W	250	900	90	3000	96 x 96 x 83	80	white	24°	34,00
308-30029600	LED 8W	250	900	90	3000	96 x 96 x 83	80	black	24°	34,00
308-30039500	LED 8W	250	900	90	3000	96 x 96 x 83	80	white	38°	34,00
308-30039600	LED 8W	250	900	90	3000	96 x 96 x 83	80	black	38°	34,00



### KONVERTER/DRIVER



ART. NR./CODE	INFO	WATT	mA	V DC	V AC	L x B x H/L x W x H	FARBE/COLOUR	PREIS/PRICE
30-880006	on/off	11W	250	44	230	156 x 43 x 30	white	13,00
24-151403	DALI	12W	250	49	230	111 x 52 x 22	white	57,20

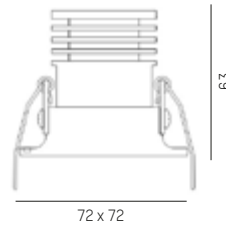

Einbaustrahler, Aluminiumdruckguss, pulverbeschichtet, zurückversetzte Lichtquelle, exkl. Konverter

Recessed spotlight, die-cast aluminium, powder-coated, with recessed light source, 2 beam angles, excl. driver

### IVY SQUARE R

ART. NR./CODE	LEISTUNG/POWER	mA	LUMEN	CRI>	KELVIN	L x B x ET/L x W x ID	⊙	FARBE/COLOUR	REFL.	PREIS/PRICE
472-0270790203005	LED 7W	200	700	90	3000	72 x 72 x 94	60	white	20°	64,00
472-0270790203006	LED 7W	200	660	90	3000	72 x 72 x 94	60	black	20°	64,00
308-0020790303004	LED 7W	200	640	90	3000	72 x 72 x 94	60	white	40°	64,00
308-0020790303005	LED 7W	200	630	90	3000	72 x 72 x 94	60	black	40°	64,00

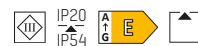

### KONVERTER/DRIVER



ART. NR./CODE	INFO	WATT	mA	V DC	V AC	L x B x H/L x W x H	FARBE/COLOUR	PREIS/PRICE
30-880006	on/off	8,5W	200	44	230	156 x 43 x 30	white	13,00
24-151395	DALI	9W	180	50	230	108 x 52 x 22	white	58,20





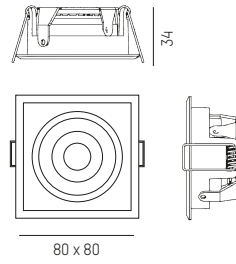

Einbaustrahler, Aluminiumdruckguss, Feinstruktur matt pulverbeschichtet, zurückversetzte Lichtquelle, exkl. Konverter

Recessed spotlight, die- cast aluminium, powder-coated, with recessed light source, excl. driver

NEW

### AGON FLAT SQUARE

ART. NR./CODE	LEISTUNG/POWER	mA	LUMEN	CRI>	KELVIN	L x B x ET/L x W x ID	Ø	FARBE/COLOUR	REFL.	PREIS/PRICE
222-00132	LED 5W	250	650	90	2700	80 x 80 x 64	68	white	55°	39,00
222-00133	LED 5W	250	650	90	2700	80 x 80 x 64	68	black	55°	39,00
222-00134	LED 5W	250	650	90	3000	80 x 80 x 64	68	white	55°	39,00
222-00135	LED 5W	250	650	90	3000	80 x 80 x 64	68	black	55°	39,00

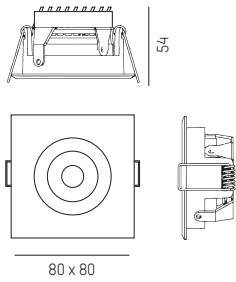

Einbaustrahler, Aluminiumdruckguss, gebürstet oder pulverbeschichtet, exkl. Konverter

Recessed spotlight, die- cast aluminium, powder-coated or brushed, excl. driver

NEW

### AGON SQUARE

ART. NR./CODE	LEISTUNG/POWER	mA	LUMEN	CRI>	KELVIN	L x B x ET/L x W x ID	Ø	FARBE/COLOUR	REFL.	PREIS/PRICE
222-00140	LED 6/11W	250/500	415/705	90	2700	80 x 80 x 84	68	white	36°	49,00
222-00141	LED 6/11W	250/500	415/705	90	2700	80 x 80 x 84	68	black	36°	49,00
222-00142	LED 6/11W	250/500	475/830	90	3000	80 x 80 x 84	68	white	36°	49,00
222-00143	LED 6/11W	250/500	475/830	90	3000	80 x 80 x 84	68	black	36°	49,00

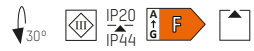

### KONVERTER/DRIVER



ART. NR./CODE	INFO	WATT	mA	V DC	V AC	L x B x H/L x W x H	FARBE/COLOUR	PREIS/PRICE
30-880006	on/off	11W/18,5W	250/500	44	230	156 x 43 x 30	white	13,00
24-151403	DALI	12W/20W	250/500	49	230	111 x 52 x 22	white	57,20





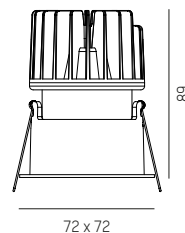

Einbaustrahler, Aluminiumdruckguss, Feinstruktur matt pulverbeschichtet, zurückversetzte Lichtquelle, exkl. Konverter

Recessed spotlight, die- cast aluminium, powder-coated, with recessed light source, excl. driver



### SATOR SQUARE R

ART. NR./CODE	LEISTUNG/POWER	mA	LUMEN	CRI>	KELVIN	L x B x ET/L x W x ID	U	FARBE/COLOUR	REFL.	PREIS/PRICE
305-30023500	LED 10W	250	600	90	2700	72 x 72 x 119	68 x 68	white	24°	49,00
305-30023600	LED 10W	250	600	90	2700	72 x 72 x 119	68 x 68	black	24°	49,00
305-30029500	LED 10W	250	620	90	3000	72 x 72 x 119	68 x 68	white	24°	49,00
305-30029600	LED 10W	250	620	90	3000	72 x 72 x 119	68 x 68	black	24°	49,00



### KONVERTER/DRIVER



ART. NR./CODE	INFO	WATT	mA	V DC	V AC	L x B x H/L x W x H	FARBE/COLOUR	PREIS/PRICE
30-880006	on/off	11W	250	44	230	156 x 43 x 30	white	13,00
24-151403	DALI	12W	250	49	230	111 x 52 x 22	white	57,20

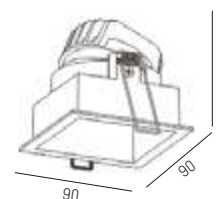

Einbaustrahler, Aluminiumdruckguss, pulverbeschichtet, zurückversetzte Lichtquelle, exkl. Konverter

Recessed spotlight, die- cast aluminium, powder-coated, with recessed light source, excl. driver



### PONTOS SQUARE

ART. NR./CODE	LUMEN/W BEI 250mA LUMEN/W WITH 250mA		CRI>	KELVIN	L x B x ET/ L x W x ID	U	FARBE/COLOUR	REFL.	PREIS/PRICE
	LED 10W	LED 15W							
305-624824w27k	810	1250	80	2700	89 x 89 x 110	78 x 78	white	24°	74,00
305-624824b27k	810	1250	80	2700	89 x 89 x 110	78 x 78	black	24°	74,00
305-624824w	870	1310	80	3000	89 x 89 x 110	78 x 78	white	24°	74,00
305-624824b	870	1310	80	3000	89 x 89 x 110	78 x 78	black	24°	74,00
305-624824w40k	870	1310	80	4000	89 x 89 x 110	78 x 78	white	24°	74,00
305-624824b40k	870	1310	80	4000	89 x 89 x 110	78 x 78	black	24°	74,00
305-624836w27k	810	1250	80	2700	89 x 89 x 110	78 x 78	white	36°	74,00
305-624836b27k	810	1250	80	2700	89 x 89 x 110	78 x 78	black	36°	74,00
305-624836w	870	1310	80	3000	89 x 89 x 110	78 x 78	white	36°	74,00
305-624836b	870	1310	80	3000	89 x 89 x 110	78 x 78	black	36°	74,00
305-624836w40k	870	1310	80	4000	89 x 89 x 110	78 x 78	white	36°	74,00
305-624836b40k	870	1310	80	4000	89 x 89 x 110	78 x 78	black	36°	74,00



### KONVERTER/DRIVER



ART. NR./CODE	INFO	WATT	mA	V DC	V AC	L x B x H/L x W x H	FARBE/COLOUR	PREIS/PRICE
30-880006	on/off	11W/15W	250/350	44	230	156 x 43 x 30	white	13,00
24-151403	DALI	12W/17W	250/350	49	230	111 x 52 x 22	white	57,20





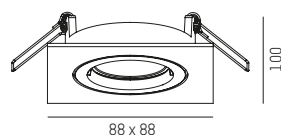

Einbaustrahler, Aluminiumdruckguss, pulverbeschichtet oder galvanisiert, inkl. 30cm Kabel, mit Bajonettverschluss

Recessed spotlight, die-cast aluminium, powder-coated or galvanized, incl. 30cm cable, with bayonet closure



### SERIE 4236 HV GU10

ART. NR./CODE	LM/BULB	FASSUNG/SOCKET	V AC	L x B x ET/L x W x ID	Ⓢ	FARBE/COLOUR	REFL.	PREIS/PRICE
8-42361hv	RETROFIT	GU10	230	88 x 88 x 120	68	brass polished	---	17,00
8-42364hv	RETROFIT	GU10	230	88 x 88 x 120	68	chrome	---	17,00
8-42366hv	RETROFIT	GU10	230	88 x 88 x 120	68	black	---	14,00
8-42367hv	RETROFIT	GU10	230	88 x 88 x 120	68	white	---	14,00
8-423646hv	RETROFIT	GU10	230	88 x 88 x 120	68	brushed nickel	---	17,00

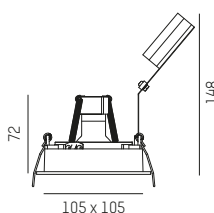

Einbaustrahler, Aluminiumdruckguss, pulverbeschichtet, rund, quadratisch und doppelte Variante

Recessed spotlight, die-cast aluminium, powder-coated, round, square and double version



NEW

### QANA SQUARE R

ART. NR./CODE	LM/BULB	FASSUNG/SOCKET	V AC	L x B x ET/L x W x ID	Ⓢ	FARBE/COLOUR	REFL.	PREIS/PRICE
222-00017	RETROFIT	GU10	230	105 x 105 x 178	95 x 95	white	---	48,00
222-00018	RETROFIT	GU10	230	105 x 105 x 178	95 x 95	black	---	48,00

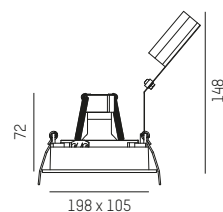

NEW

### QANA DOUBLE SQUARE R

ART. NR./CODE	LM/BULB	FASSUNG/SOCKET	V AC	L x B x ET/L x W x ID	Ⓢ	FARBE/COLOUR	REFL.	PREIS/PRICE
222-00019	RETROFIT	GU10	230	198 x 105 x 178	188 x 95	white	---	94,00
222-00020	RETROFIT	GU10	230	198 x 105 x 178	188 x 95	black	---	94,00



### LEUCHTMITTEL/LIGHT SOURCE

Weitere Leuchtmittel S./additional light sources P. 290

ART. NR./CODE	INFORMATION	PREIS/PRICE
30-752517	Core Pro LED Spot, GU10,5W, 827 Kelvin	6,50

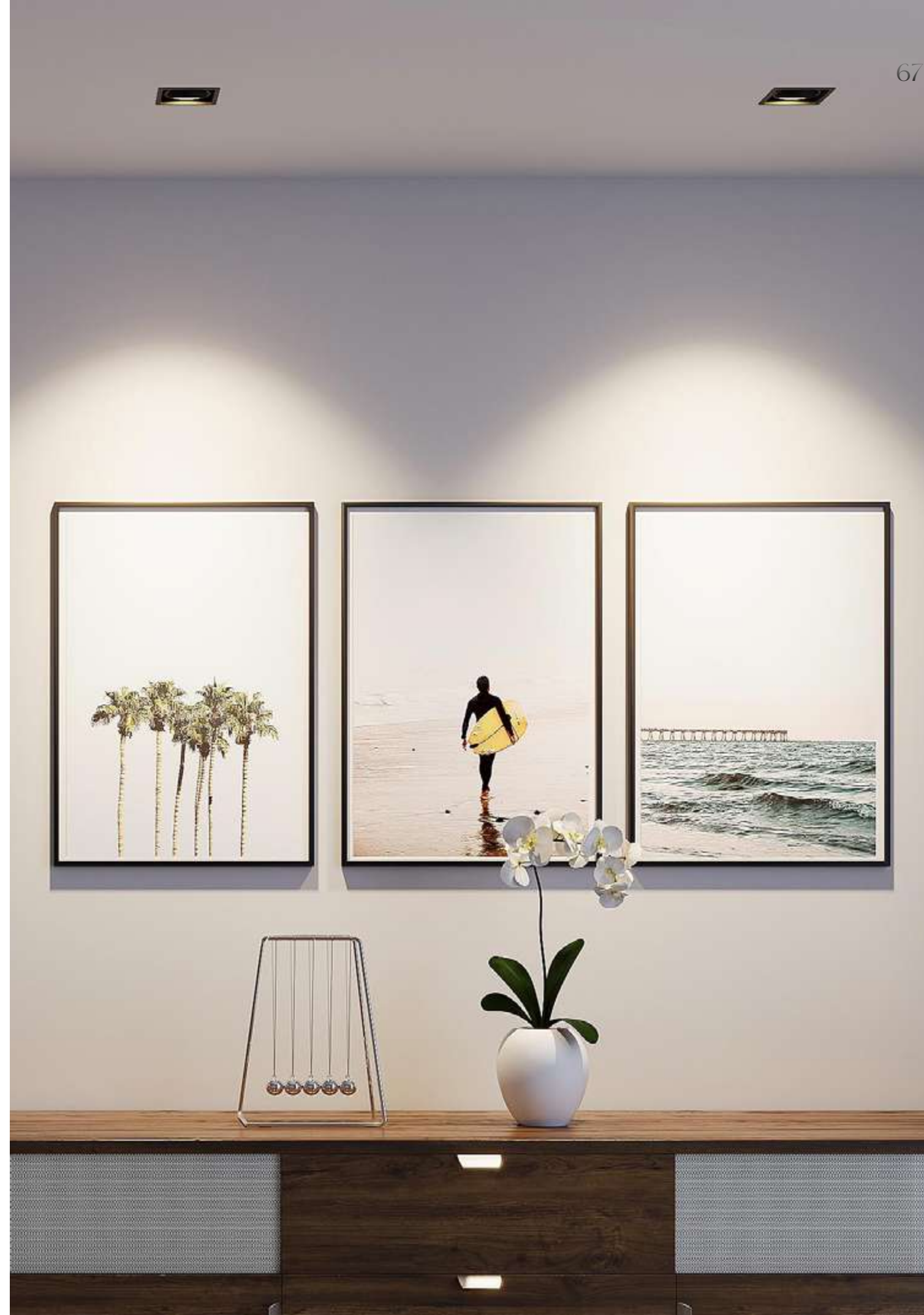







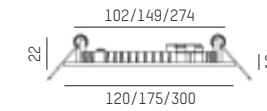

Einbauleuchte, Aluminium, weiß matt lackiert, passiv gekühlt, sehr homogene Ausleuchtung, opaler Diffusor, extrem flach, exkl. Konverter, Achtung: ca. 30mm Platz für Konverter einplanen

Recessed luminaire, aluminium, painted, passive cooling, very homogeneous illumination, opal diffuser, extremely flat, excl. driver. Attention: approx. 30 mm space needed for driver

### MOON ROUND R

ART. NR./CODE	LEISTUNG/POWER	mA	LUMEN	CRI>	KELVIN	Ø x ET/Ø x ID	⊕	FARBE/COLOUR	REFL.	PREIS/PRICE
139-0000680003005	LED 6W	250	770	80	3000	120 x 54	110	white matt	114°	24,00
139-0000680004005	LED 6W	250	835	80	4000	120 x 54	110	white matt	114°	24,00
139-0011280003005	LED 12W	500	1730	80	3000	175 x 54	160	white matt	114°	35,00
139-0011280004005	LED 12W	500	1780	80	4000	175 x 54	160	white matt	114°	35,00
139-0021880003005	LED 17W	700	2500	80	3000	300 x 54	285	white matt	113°	69,00
139-0021880004005	LED 17W	700	2450	80	4000	300 x 54	285	white matt	113°	69,00

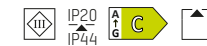

### AUFBAUGEHÄUSE/SURFACE HOUSING

ART. NR./CODE	INFO	Ø x H/Ø x H	FARBE/COLOUR	PREIS/PRICE
643-1001	Aufbaugehäuse, Stahlblech, weiß matt lackiert, exkl. Leuchte und Konverter/	124 x 45	white matt	59,00
643-1002	Surface housing, sheet steel, white matt powder-coated, dimmable, excl. luminaire and driver	180 x 45	white matt	69,00
643-1003		304 x 45	white matt	109,00

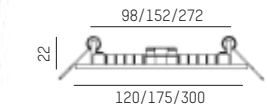

### MOON SQUARE R

ART. NR./CODE	LEISTUNG/POWER	mA	LUMEN	CRI>	KELVIN	L x B x ET/L x W x ID	⊕	FARBE/COLOUR	REFL.	PREIS/PRICE
139-0030680003005	LED 6W	250	730	80	3000	120 x 120 x 54	105 x 105	white matt	110°	25,00
139-0030680004005	LED 6W	250	785	80	4000	120 x 120 x 54	105 x 105	white matt	110°	25,00
139-0041280003005	LED 12W	500	1640	80	3000	175 x 175 x 54	160 x 160	white matt	114°	39,00
139-0041280004005	LED 12W	500	1700	80	4000	175 x 175 x 54	160 x 160	white matt	114°	39,00
139-0051880003005	LED 17W	700	2285	80	3000	300 x 300 x 54	275 x 275	white matt	114°	79,00
139-0051880004005	LED 17W	700	2300	80	4000	300 x 300 x 54	275 x 275	white matt	114°	79,00



### AUFBAUGEHÄUSE/SURFACE HOUSING

ART. NR./CODE	INFO	L x B x H/L x W x H	FARBE/COLOUR	PREIS/PRICE
643-0001	Aufbaugehäuse, Stahlblech, weiß matt lackiert, exkl. Leuchte und Konverter/	125 x 125 x 45	white matt	66,00
643-0002	Surface housing, sheet steel, white matt powder-coated, dimmable, excl. luminaire and driver	180 x 180 x 45	white matt	69,00
643-0003		305 x 305 x 45	white matt	99,00



### KONVERTER/DRIVER

ART. NR./CODE	INFO	WATT	mA	V DC	V AC	FÜR/FÜR	L x B x H/L x W x H	FARBE/COLOUR	PREIS/PRICE
30-880006	on/off	11W	250	44	230	MOON 120	156 x 43 x 30	white	13,00
30-880106	on/off	22/30W	500/700	44	230	1 MOON 175 / 1 MOON 300	156 x 43 x 30	white	14,00
24-127719	on/off	6W	250	23	230	1 MOON 120	42 x 40 x 22	black	19,80
24-151403	DALI	12/20/20W	250/500/700	49/40/28	230	1-2 MOON 120/ 1 MOON 175/300	111 x 52 x 22	white	57,20



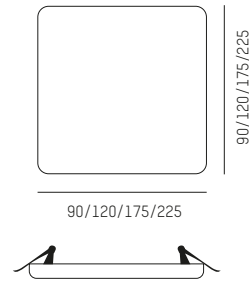

Halbeinbauleuchte, Aluminium, weiß matt lackiert, passiv gekühlt, quadratisch, sehr homogene Ausleuchtung, opaler Diffusor, 118 Grad Ausstrahlwinkel, Aufbauhöhe 20 mm, exkl. Konverter, Lichtfarbe mittels DIP-Switch einstellbar

Semi recessed luminaire, aluminium, white matt painted, passive cooling, square, very homogeneous illumination, opaldiffuser, 118° beam angle, surface height 20 mm, exkl. driver, Light colour adjustable with DIP-Switch



## MAAN SQUARE

ART. NR./CODE	LEISTUNG/POWER	mA	LUMEN	CRI>	KELVIN	L x B x ET/L x W x ID	⊙	PREIS/PRICE
139-000209201105	LED 5W	250	718/762/743	80	2700/3300/4000	90 x 90 x 50	50 - 75	19,00
139-000212201105	LED 13W	350	1888/2043/1952	80	2700/3300/4000	120 x 120 x 50	70 - 100	25,00
139-000218201105	LED 18W	500	2786/2937/2853	80	2700/3300/4000	175 x 175 x 50	70 - 150	39,00
139-000223201105	LED 32W	900	4915/5195/5062	80	2700/3300/4000	225 x 225 x 50	70 - 205	59,00



DIP-Switch

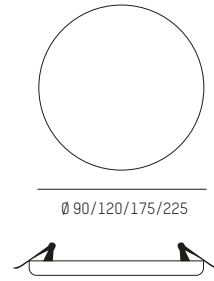

Halbeinbauleuchte, Aluminium, weiß matt lackiert, passiv gekühlt, rund, sehr homogene Ausleuchtung, opaler Diffusor, 118 Grad Ausstrahlwinkel, Aufbauhöhe 16 mm, exkl. Konverter, Lichtfarbe mittels DIP-Switch einstellbar

Semi recessed luminaire, aluminium, white matt painted, passive cooling, round, very homogeneous illumination, opaldiffuser, 118° beam angle, surface height 16 mm, exkl. driver, Light colour adjustable with DIP-Switch



## MAAN ROUND

ART. NR./CODE	LEISTUNG/POWER	mA	LUMEN	CRI>	KELVIN	∅ x ET/L x W x ID	⊙	PREIS/PRICE
139-000109201105	LED 5W	250	707/757/733	80	2700/3300/4000	90 x 50	50 - 75	19,00
139-000112201105	LED 13W	350	1846/2008/1894	80	2700/3300/4000	120 x 50	70 - 100	25,00
139-000118201105	LED 18W	500	2759/2919/2847	80	2700/3300/4000	175 x 50	70 - 150	39,00
139-000123201105	LED 32W	900	4877/5192/5047	80	2700/3300/4000	225 x 50	70 - 205	59,00



DIP-Switch

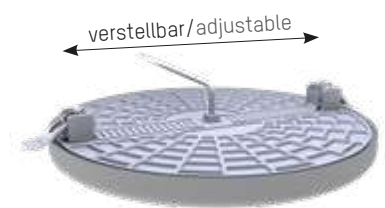

## KONVERTER/DRIVER

ART. NR./CODE	INFO	WATT	mA	V DC	V AC	L x B x H/L x W x H	FARBE/COLOUR	PREIS/PRICE
30-880006	on/off	11W/15W/18,5W	250/350/500	44/44/37	230	156 x 43 x 30	white	13,00
24-151403	DALI	12W-20W	250-700	47-28	230	111 x 52 x 22	white	57,20
30-880206	on/off	39W	900	44	230	156 x 43 x 30	white	15,00
24-127490	DALI	16W-38W	300-1050	54-34	230	147 x 44 x 30	white	67,80







### HALOX-100 GEHÄUSE MIT TRAFOTUNNEL HALOX-100 HOUSING WITH TUNNEL

ART. NR./CODE	Ø	FARBE/COLOUR	PREIS/PRICE
113-128130	130	grey	44,50



### HALOX-100 GEHÄUSE/HOUSING

ART. NR./CODE	Ø	FARBE/COLOUR	PREIS/PRICE
113-128100	130	grey	18,00



### HALOX-100 UNIVERSALFRONTTEIL HALOX-100 UNIVERSAL FRONT PARTS

ART. NR./CODE	Ø	FARBE/COLOUR	PREIS/PRICE
113-128111	max. 100	grey	34,90



### HALOX-100 UNIVERSALFRONTTEIL HALOX-100 UNIVERSAL FRONT PARTS

ART. NR./CODE	Ø	FARBE/COLOUR	PREIS/PRICE
113-128110	max. 100	grey	12,70



### HALOX-100 FRONTTEILE HALOX 100 FRONT PARTS

ART. NR./CODE	Ø	FARBE/COLOUR	PREIS/PRICE
113-128108	68 x 68 (Leuchtenblende/Luminaire cover min. 75 x 75)	grey	11,10
113-128109	75 x 75 (Leuchtenblende/Luminaire cover min. 82 x 82)	grey	11,10

Einbauhöhe inkl. Frontteil 120 mm, 4 Schlagkupplungen M20/25, Kombinationseinführung mit Rohreinleitungsbegrenzung zur Vermeidung innerer Rohrkürzung, für Leuchten mit Einbaudurchmesser 0-100mm, max. Einbauhöhe Leuchte 110 mm, Lampenleistung LED max. 20 W, Lampenleistung NV/HV/TC max. 50W, Tunnel für Aufnahme von Betriebsgeräten in entsprechender Größe (Tunnel LxWxH = 190x140x85mm)

Installation height including front part 120 mm, 4 impact couplings M20/25, combination entry with conduit entry restriction to avoid inner conduit shortening, for lights with an installation diameter of 0-100mm, max. light installation height 110 mm, LED lamp power max 20W, lamp power NV/HV/TC max. 50W, tunnel for the installation of control gear of the appropriate size (tunnel LxWxH = 190x140x85mm)

Einbauhöhe inkl. Frontteil 120 mm, 2 Schlagkupplungen M20/25, Kombinationseinführung mit Rohreinleitungsbegrenzung zur Vermeidung innerer Rohrkürzung, für Leuchten mit Einbaudurchmesser 0-100mm, max. Einbauhöhe Leuchte 110 mm, Lampenleistung LED max. 20 W, Lampenleistung NV/HV/TC max. 50W

Installation height including front part 120 mm, 2 impact couplings M20/25, combination entry with conduit entry limiter to avoid inner conduit shortening, for lights with an installation diameter of 0-100mm, max. light installation height 110 mm, lamp power LED max. 20 W, lamp power NV/HV/TC max. 50W

Variabler Deckenauslass mit Mineralfaserplatte, Deckenauslass bis Ø max. 100 mm stufenlos möglich, zeitsparend ohne weitere Nacharbeiten evtl. Oberfläche glätten

variable ceiling exit with mineral fiber board, ceiling outlet up to Ø max. 100 mm infinitely variable, time-saving without further reworking smooth the surface if necessary

variabler Deckenauslass für Ø von 0-100 mm

variable ceiling exit for Ø from 0-100 mm

HALOX Frontteil für quadratischen Deckenauslass - verschiedene Ausführungen für entsprechende Außenabmessungen

HALOX front part for square ceiling exit - different versions for appropriate external dimensions



HALOX Frontteil für quadratischen Deckenauslass - verschiedene Ausführungen für entsprechende Außenabmessungen

HALOX front part for square ceiling exit - different versions for appropriate external dimensions

### HALOX-100 FRONTTEILE HALOX 100 FRONT PARTS

ART. NR./CODE	Ø	FARBE/COLOUR	PREIS/PRICE
113-128101	68 (Leuchtenblende/Luminaire cover min. 75)	grey	11,10
113-128102	75 (Leuchtenblende/Luminaire cover min. 82)	grey	11,10
113-128103	80 (Leuchtenblende/Luminaire cover min. 87)	grey	11,10
113-128104	85 (Leuchtenblende/Luminaire cover min. 92)	grey	11,10
113-128106	95 (Leuchtenblende/Luminaire cover min. 102)	grey	11,10
113-128107	100 (Leuchtenblende/Luminaire cover min. 107)	grey	11,10

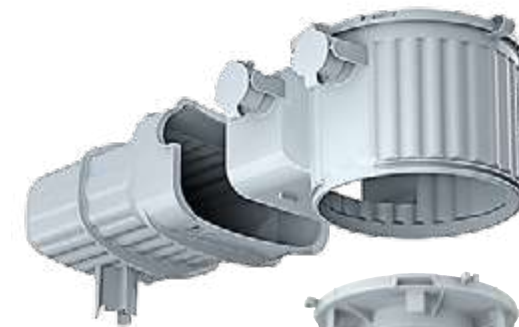

### BETON-EINBAUGEHÄUSE HALOX-100 FÜR ORTBETON HALOX 100 CONCRETE HOUSING FOR ON-SITE MIXED CONCRETE

#### INFORMATION

Für Halogenleuchten (Hochvolt und Niedervolt) und Lautsprecher in Ortbeton an einer Deckenstärke von 160 mm steht Ihnen mit HaloX-0 ein umfangreiches Gehäusesystem zur Verfügung. Runde und quadratische Frontteile, Frontteile mit Mineralfaserplatten, Trafo-Tunnel und Zubehör ermöglichen vielfältige Einbaumöglichkeiten.

For halogen luminaires (high voltage and low voltage) and loudspeakers in on-site concrete, from a ceiling thickness of 60 mm, From a ceiling thickness of 160mm, halox offers you a comprehensive housing system. Round and square front parts, front parts with mineral fibreboards, transformer tunnels and accessories enable a wide range of installation options.

### ABMESSUNGEN & INFO MEASUREMENTS & INFO INFORMATION

- Starre und kardanbefestigte Leuchten
- Lampenleistung max. 50 W
- Nur geprüfte (DIN VDE 0711 / EN 60598) sowie mit  $\nabla$  oder  $\nabla/\nabla$  gekennzeichnete Leuchten verwenden.

- fixed and gimbal-mounted luminaires
- lamp power max. 50W
- Use only tested (DIN VDE 0711 / EN60598) as well as with  $\nabla$  or  $\nabla/\nabla$  marked luminaires.

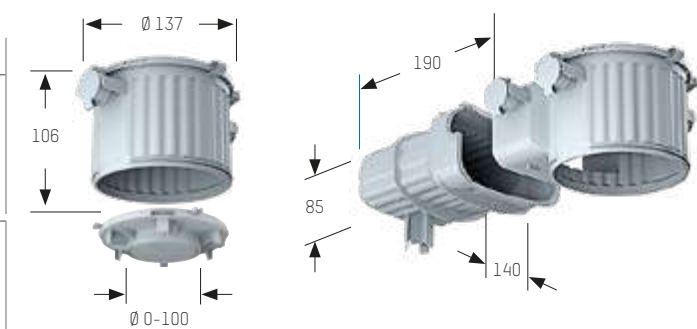
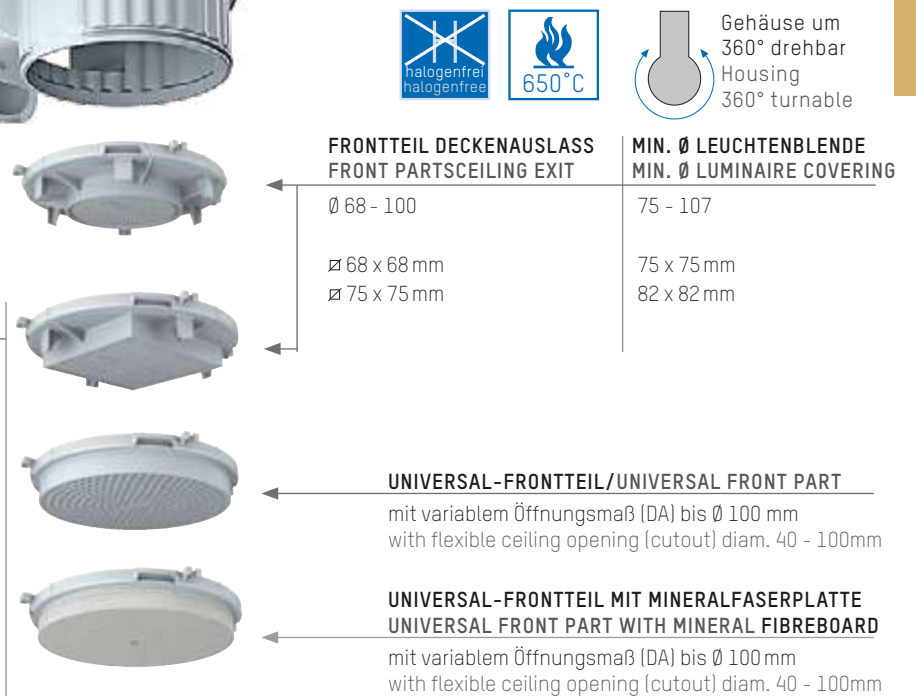



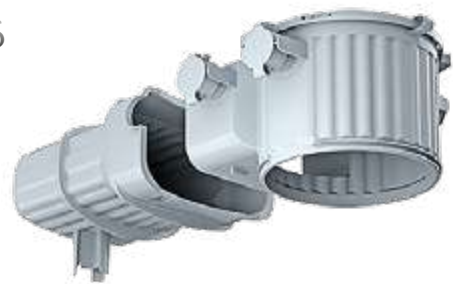

**HALOX-180 GEHÄUSE MIT TRAFOTUNNEL**  
**HALOX-180 HOUSING WITH TUNNEL**

ART. NR./CODE	Ø	FARBE/COLOUR	PREIS/PRICE
113-128230	210	grey	74,10



**HALOX-180 GEHÄUSE/HOUSING**

ART. NR./CODE	Ø	FARBE/COLOUR	PREIS/PRICE
113-128200	210	grey	36,00



**HALOX-180 UNIVERSALFRONTTEIL**  
**UNIVERSAL FRONT PARTS**

ART. NR./CODE	Ø	FARBE/COLOUR	PREIS/PRICE
113-128211	max. 180	grey	42,40



**HALOX-180 UNIVERSALFRONTTEIL**  
**HALOX-180 UNIVERSAL FRONT PARTS**

ART. NR./CODE	Ø	FARBE/COLOUR	PREIS/PRICE
113-128210	max. 180	grey	30,70



**HALOX-180 FRONTTEILE**  
**HALOX 180 FRONT PARTS**

ART. NR./CODE	Ø	FARBE/COLOUR	PREIS/PRICE
113-128201	100 (Leuchtenblende/Luminaire cover min. 107)	grey	17,50
113-128202	110 (Leuchtenblende/Luminaire cover min. 117)	grey	17,50
113-128203	125 (Leuchtenblende/Luminaire cover min. 132)	grey	17,50
113-128204	145 (Leuchtenblende/Luminaire cover min. 152)	grey	17,50
113-128206	160 (Leuchtenblende/Luminaire cover min. 167)	grey	17,50

Einbauhöhe inkl. Frontteil 120 mm, 4 Schlagkupplungen M20/25, Kombinationseinführung mit Rohrein- führungsbegrenzung zur Ver- meidung innerer Rohrkürzung, für Leuchten mit Einbaudurchmesser 0-180mm, max. Einbauhöhe Leuchte 110 mm, Lampenleistung LED max. 35 W, Lampenleistung NV/ HV/TC max. 75W, Tunnel für Auf- nahme von Betriebsgeräten in ent- sprechender Größe (Tunnel L x B x H = 190 x 140 x 85mm)

Installation height including front part 120 mm, 4 impact couplings M20/25, combination entry with conduit entry restriction to avoid inner conduit shortening, for lights with an installation diameter of 0-180mm, max. light instal- lation height 110 mm, LED lamp power max 35W, lamp power NV/ HV/TC max. 75W, tunnel for the installation of control gear of the appropriate size (tunnel L x W x H = 190 x 140 x 85mm)

Einbauhöhe inkl. Frontteil 120 mm, 2 Schlagkupplungen M20/25, Kombinationseinführung mit Rohrein- führungsbegrenzung zur Ver- meidung innerer Rohrkürzung, für Leuchten mit Einbaudurchmes- ser 0-180mm, max. Einbauhöhe Leuchte 110 mm, Lampenleistung LED max. 35 W, Lampenleistung NV/HV/TC max. 75W

Installation height including front part 120 mm, 2 impact couplings M20/25, combination entry with conduit entry limiter to avoid inner conduit shortening, for lights with an installation diameter of 0-180mm, max. light installation height 110 mm, lamp power LED max. 35 W, lamp power NV/HV/TC max.75W

Variabler Deckenauslass mit Mine- ralfaserplatte, Deckenauslass bis Ø max. 180 mm stufenlos möglich, zeitsparend ohne weitere Nach- arbeiten evtl. Oberfläche glätten

variable ceiling exit with mineral fiber board, ceiling outlet up to Ø max. 180 mm infinitely variable, time-saving without further reworking smooth the surface if necessary

variabler Deckenauslass für Ø von 0-180 mm

variable ceiling exit for Ø from 0-180 mm

HALOX Frontteil für quadratischen Deckenauslass - verschiedene Ausführungen für entsprechende Außenabmessungen

HALOX front part for square ceiling exit - different versions for appropriate external dimensions

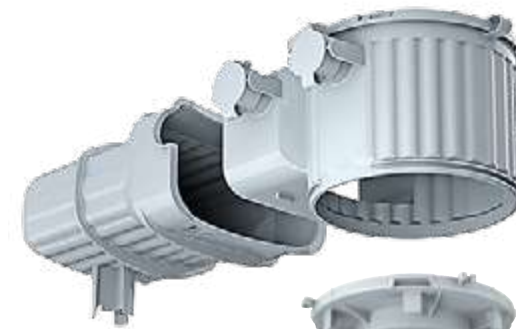

**BETON-EINBAUGEHÄUSE HALOX-180 FÜR ORTBETON**  
**HALOX 180 CONCRETE HOUSING FOR ON-SITE MIXED CONCRETE**

**INFORMATION**

Für Leuchten und Lautsprecher in Ortbeton steht Ihnen mit HaloX ein umfangreiches Gehäusesystem zur Verfügung. Runde Frontteile, Frontteile mit Mineral- faserplatten, Trafo-Tunnel und Zubehör ermöglichen vielfältige Einbaumöglichkeiten.

For halogen luminaires (high voltage and low vol- tage) and loudspeakers in on-site concrete, from a ceiling thickness of 60 mm , From a ceiling thick- ness of 160mm, halox offers you a comprehen- sive housing system. Round and square front parts, front parts with mineral fibreboards, transformer tunnels and accessories enable a wide range of installation options.

**ABMESSUNGEN & INFO**  
**MEASUREMENTS & INFO**  
**INFORMATION**

- Starre und kardanbefestigte Leuchten
- Lampenleistung max. 75W
- Nur geprüfte (DIN VDE 0711/ EN 60598) sowie mit  $\nabla$  oder  $\nabla/\nabla$  gekennzeichnete Leuchten verwenden.

- fixed and gimbal-mounted luminaires
- lamp power max. 75W
- Use only tested (DIN VDE 0711 / EN60598) as well as with  $\nabla$  or  $\nabla/\nabla$  marked luminaires.

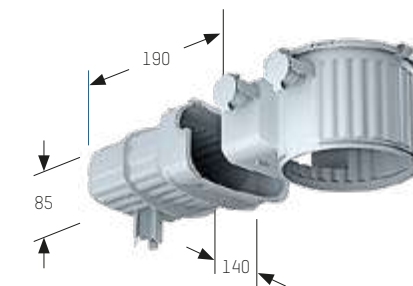

Gehäuse um 360° drehbar  
Housing 360° turnable

FRONTTEIL DECKENAUSLASS  
FRONT PARTSCEILING EXIT

Ø 100 - 180

MIN. Ø LEUCHTENBLENDE  
MIN. Ø LUMINAIRE COVERING

Ø 107 - 187

UNIVERSAL-FRONTTEIL/UNIVERSAL FRONT PART

mit variablem Öffnungsmaß (DA) bis Ø 180 mm  
with flexible ceiling opening (cutout) diam. 40 - 180mm

UNIVERSAL-FRONTTEIL MIT MINERALFASERPLATTE  
UNIVERSAL FRONT PART WITH MINERAL FIBREBOARD

mit variablem Öffnungsmaß (DA) bis Ø 180 mm  
with flexible ceiling opening (cutout) diam. 40 - 180mm



Ohne Abdeckung aus ver- zinktem Blech, nicht für Sichtbeton geeignet, je eine Schlaucheinführung DM 20mm und 25mm links und rechts, Abdeckung separat or- dern

Without cover made of galva- zinktem Blech, not suita- ble for fair-faced concrete, one hose entry each DM20mm and 25mm left and right, order cover separately

**UNIVERSAL BETONEINBAUGEHÄUSE**  
**UNIVERSAL CONCRETE HOUSING**

ART. NR./CODE	L x B x H/L x W x H	PREIS/PRICE
332-1001	170 x 170 x 116	47,70
332-2001	450 x 303 x 136	83,70

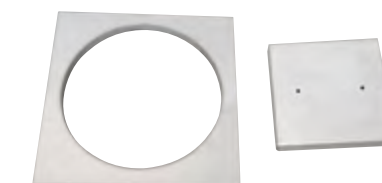

Ohne Abdeckung aus ver- zinktem Blech, nicht für Sichtbeton geeignet, je eine Schlaucheinführung DM 20mm und 25mm links und rechts, Abdeckung separat or- dern

Without cover made of galva- zinktem Blech, not suita- ble for fair-faced concrete, one hose entry each DM20mm and 25mm left and right, order cover separately

**ABDECKUNG RUND**  
**COVER ROUND**

ART. NR./CODE	FÜR/FOR	LxBxH/LxWxH	Ø	PREIS/PRICE
332-3r170	SPEAKER 1, ENERGY 2180	300 x 250 x 16	170	41,30



DECKENAUFBAULEUCHTEN  
SURFACE LUMINAIRES





80



Runde LED Aufbauleuchte aus Aluminium, matt Feinstruktur pulverbeschichtet, inkl. Konverter

LED surface mounted luminaire, aluminium, powder-coated, fixed, incl. driver

### AEON ROUND SMALL

ART. NR./CODE	LEISTUNG/POWER	LUMEN	CRI>	KELVIN	Ø x H	FARBE/COLOUR	REFL.	PREIS/PRICE
305-602527w	SYS 6W	475	80	2700	80 x 95	white	45°	94,00
305-602527b	SYS 6W	475	80	2700	80 x 95	black	45°	94,00
305-602530w	SYS 6W	475	80	3000	80 x 95	white	45°	94,00
305-602530b	SYS 6W	475	80	3000	80 x 95	black	45°	94,00



Runde LED Aufbauleuchte aus Aluminium, matt Feinstruktur pulverbeschichtet, inkl. Konverter, DALI dimmbar

Round LED surface-mounted light made of aluminium, matt fine structure powder-coated, incl. converter, DALI dimmable

### AEON ROUND BIG

ART. NR./CODE	LEISTUNG/POWER	LUMEN	CRI>	KELVIN	Ø x H	FARBE/COLOUR	REFL.	PREIS/PRICE
305-604527wddd	SYS 15W	1015	80	2700	125 x 158	white	50°	279,00
305-604527bddd	SYS 15W	1015	80	2700	125 x 158	black	50°	279,00
305-604530wddd	SYS 15W	1160	80	3000	125 x 158	white	50°	259,00
305-604530bddd	SYS 15W	1160	80	3000	125 x 158	black	50°	259,00

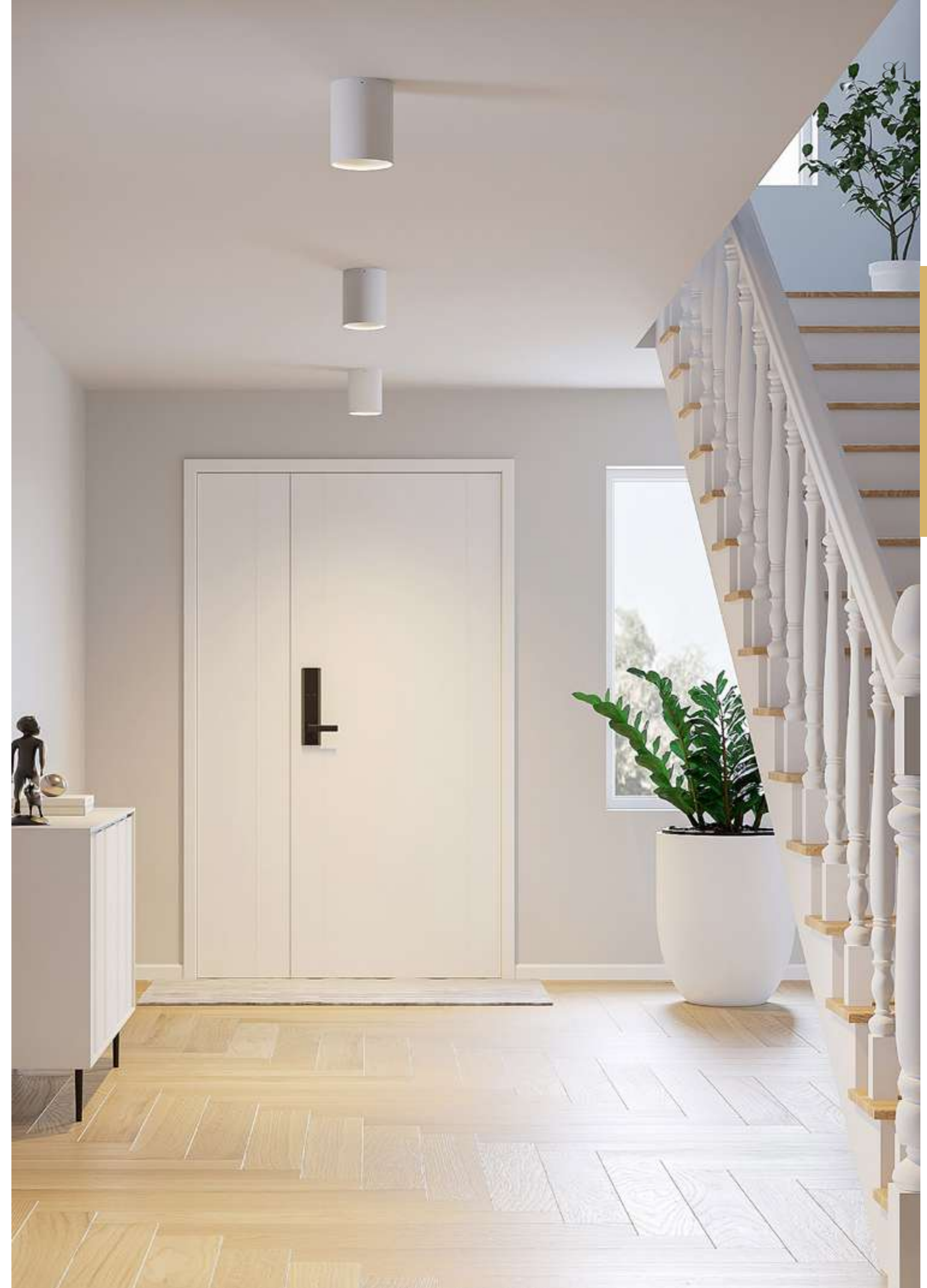





Quadratische LED Aufbauleuchte aus Aluminium, matt Feinstruktur pulverbeschichtet, inkl. Konverter

LED surface mounted luminaire, aluminium, powder-coated, fixed, incl. driver

### AEON SQUARE SMALL



ART. NR./CODE	LEISTUNG/POWER	LUMEN	CRI>	KELVIN	L x B x H/L x W x H	FARBE/COLOUR	REFL.	PREIS/PRICE
305-602427w	SYS 6W	430	80	2700	80 x 80 x 95	white	45°	94,00
305-602427b	SYS 6W	430	80	2700	80 x 80 x 95	black	45°	94,00
305-602430w	SYS 6W	495	80	3000	80 x 80 x 95	white	45°	94,00
305-602430b	SYS 6W	495	80	3000	80 x 80 x 95	black	45°	94,00



Quadratische LED Aufbauleuchte aus Aluminium, matt Feinstruktur pulverbeschichtet, inkl. Konverter, DALI dimmbar

LED surface mounted luminaire, aluminium, powder-coated, fixed, incl. driver, DALI dimmable

### AEON SQUARE BIG



ART. NR./CODE	LEISTUNG/POWER	LUMEN	CRI>	KELVIN	L x B x H/L x W x H	FARBE/COLOUR	REFL.	PREIS/PRICE
305-604427wddd	SYS 15W	1005	80	2700	120 x 120 x 158	white	50°	259,00
305-604427bddd	SYS 15W	1005	80	2700	120 x 120 x 158	black	50°	259,00
305-604430wddd	SYS 15W	1180	80	3000	120 x 120 x 158	white	50°	259,00
305-604430bddd	SYS 15W	1180	80	3000	120 x 120 x 158	black	50°	279,00

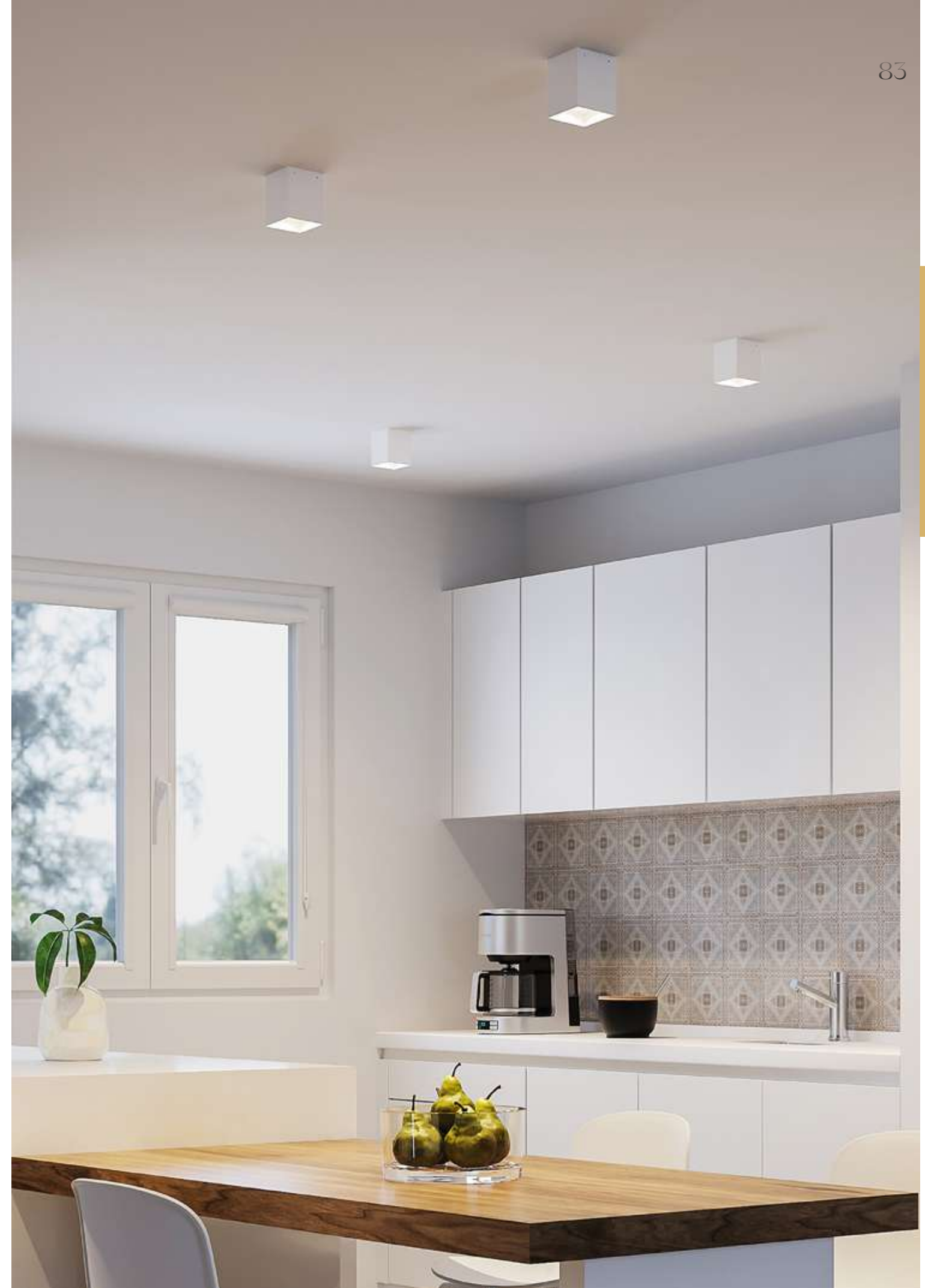





Aufbauleuchte, Aluminiumdruckguss, Feinstruktur pulverbeschichtet, inkl. Konverter

Surface mounted luminaire, die-cast aluminium, powder-coated, incl. driver

### POLUS



ART. NR./CODE	LEISTUNG/POWER	LUMEN	CRI>	KELVIN	L x B x H/L x W x H	FARBE/COLOUR	REFL.	PREIS/PRICE
276-0091190003005	SYS 12W	606	90	3000	105 x 105 x 105	white/white	---	175,00
276-0091190003063	SYS 12W	580	90	3000	105 x 105 x 105	black/gold	---	179,00



Aufbauleuchte, AC-LED, Aluminium, Feinstruktur pulverbeschichtet, mit geschlossenem opalem Acryldiffusor, homogene Lichtverteilung

Surface mounted luminaire, AC-LED, aluminium, powder-coated, with closed opal acrylic diffuser, homogeneous light distribution

### UP AC



ART. NR./CODE	LEISTUNG/POWER	LUMEN	CRI>	KELVIN	L x B x H/L x W x H	FARBE/COLOUR	REFL.	PREIS/PRICE
472-0501090002705	SYS 10W	576	90	2700	100 x 100 x 63	white	---	199,00
472-0501090002706	SYS 10W	461	90	2700	100 x 100 x 63	black	---	199,00
472-0501090002704	SYS 10W	486	90	2700	100 x 100 x 63	silver	---	199,00
472-0501090003005	SYS 10W	640	90	3000	100 x 100 x 63	white	---	199,00
472-0501090003006	SYS 10W	515	90	3000	100 x 100 x 63	black	---	199,00
472-0501090003004	SYS 10W	540	90	3000	100 x 100 x 63	silver	---	199,00

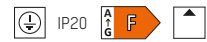

LED Aufbauleuchte aus Aluminium, pulverbeschichtet, zurückversetzte Lichtquelle, inkl. Konverter

LED surface mounted luminaire, aluminium, powder-coated, with recessed light source, incl. driver

### LIRO SD



ART. NR./CODE	LEISTUNG/POWER	LUMEN	CRI>	KELVIN	L x B x H/L x W x H	FARBE/COLOUR	REFL.	PREIS/PRICE
472-20073560	SYS 10W	620	90	2700	60 x 60 x 70	white/black	10°	129,00
472-20073660	SYS 10W	620	90	2700	60 x 60 x 70	black	10°	129,00
472-20083560	SYS 10W	620	90	2700	60 x 60 x 70	white/black	30°	129,00
472-20083660	SYS 10W	620	90	2700	60 x 60 x 70	black	30°	129,00
472-20079560	SYS 10W	650	90	3000	60 x 60 x 70	white/black	10°	129,00
472-20079660	SYS 10W	650	90	3000	60 x 60 x 70	black	10°	129,00
472-20089560	SYS 10W	650	90	3000	60 x 60 x 70	white/black	30°	129,00
472-20089660	SYS 10W	650	90	3000	60 x 60 x 70	black	30°	129,00

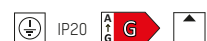





Aufbauleuchte, Aluminiumdruckguss, matt Feinstruktur pulverbeschichtet, zylindrisch, Acryldiffusor matt satiniert, inkl. Konverter

Surface mounted luminaire, die-cast aluminium, powder-coated, cylindrical, acrylic diffuser matt satined, incl. driver

**CARMİ**



ART. NR./CODE	LEISTUNG/POWER	LUMEN	CRI>	KELVIN	L x H	FARBE/COLOUR	REFL.	PREIS/PRICE
472-1227050	SYS 13W	550	90	2700	140 x 55	white	---	199,00
472-1227060	SYS 13W	455	90	2700	140 x 55	black	---	199,00
472-12270630	SYS 13W	540	90	2700	140 x 55	black/gold	---	199,00
472-1229050	SYS 13W	615	90	3000	140 x 55	white	---	199,00
472-1229060	SYS 13W	510	90	3000	140 x 55	black	---	199,00
472-12290630	SYS 13W	540	90	3000	140 x 55	black/gold	---	199,00



Aufbauleuchte, Aluminiumdruckguss, matt Feinstruktur pulverbeschichtet, zylindrisch, Acryldiffusor matt satiniert, inkl. Konverter

Surface mounted luminaire, die-cast aluminium, powder-coated, cylindrical, acrylic diffuser matt satined, incl. driver

**ARIK SHORT**



ART. NR./CODE	LEISTUNG/POWER	LUMEN	CRI>	KELVIN	Ø x H	FARBE/COLOUR	REFL.	PREIS/PRICE
472-260029	SYS 11W	744	90	3000	99 x 70	white	---	159,00
472-260030	SYS 11W	744	90	3000	99 x 70	black	---	159,00







Deckenaufbauleuchte, Aluminium, pulverbeschichtet, direkt strahlend, opaler Diffuser, Lichtfarbe einstellbar mittels Schalter auf LED-Board, inkl. Konverter

Ceiling luminaire, aluminium, powder coated, direct beam, opal diffuser, Light colour is adjustable with a switch on the LED board, incl. driver

## DESCO M



ART. NR./CODE	LEISTUNG/POWER	LUMEN	CRI>	KELVIN	Ø x H	FARBE/COLOUR	REFL.	PREIS/PRICE
341-r2419150	SYS 15W	1005/983/972	90	2700/3000/4000	240 x 50	white	113°	189,00
341-r2419160	SYS 15W	1005/983/972	90	2700/3000/4000	240 x 50	black	113°	189,00

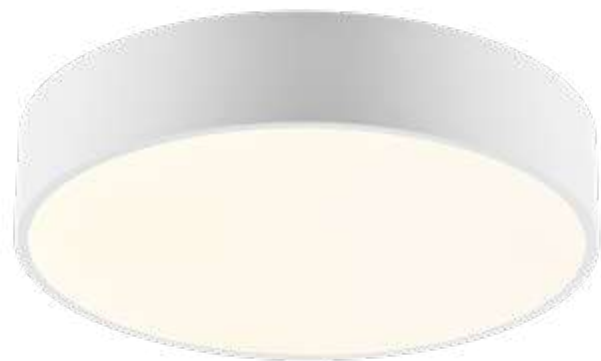

Deckenaufbauleuchte, Aluminium, pulverbeschichtet, direkt strahlend, opaler Diffuser, Lichtfarbe einstellbar mittels Schalter auf LED-Board, inkl. Konverter

Ceiling luminaire, aluminium, powder coated, direct beam, opal diffuser, Light colour is adjustable with a switch on the LED board, incl. driver

## DESCO L



ART. NR./CODE	LEISTUNG/POWER	LUMEN	CRI>	KELVIN	Ø x H	FARBE/COLOUR	REFL.	PREIS/PRICE
341-r3319150	SYS 21W	1526/1567/1554	90	2700/3000/4000	330 x 74	white	113°	239,00
341-r3319160	SYS 21W	1526/1567/1554	90	2700/3000/4000	330 x 74	black	113°	239,00







Wand- und Deckenaufbauleuchte, Aluminiumdruckguss, stufenlos dimmbar, starr oder dreh- und schwenkbar, Phasenabschnitt dimmbar  
 Surface-mounted wall and ceiling light, die-cast aluminium, stepless dimmable, fixed or rotatable and swivelling, phase cut dimming

NEW

MAG SDI



ART. NR./CODE	LEISTUNG/POWER	LUMEN	CRI>	KELVIN	Ø x H	FARBE/COLOUR	REFL.	PREIS/PRICE
222-00005	SYS 16W	1180	90	2700	120 x 69	white	40°	199,00
222-00006	SYS 16W	1180	90	2700	120 x 69	black	40°	199,00
222-00144	SYS 16W	1280	90	3000	120 x 69	white	40°	199,00
222-00145	SYS 16W	1280	90	3000	120 x 69	black	40°	199,00



NEW

MAG SD TURN



ART. NR./CODE	LEISTUNG/POWER	LUMEN	CRI>	KELVIN	Ø x H	FARBE/COLOUR	REFL.	PREIS/PRICE
222-00007	SYS 13W	940	90	2700	120 x 81	white	40°	219,00
222-00008	SYS 13W	940	90	2700	120 x 81	black	40°	219,00
222-00146	SYS 16W	1040	90	3000	120 x 81	white	40°	219,00
222-00147	SYS 16W	1040	90	3000	120 x 81	black	40°	219,00

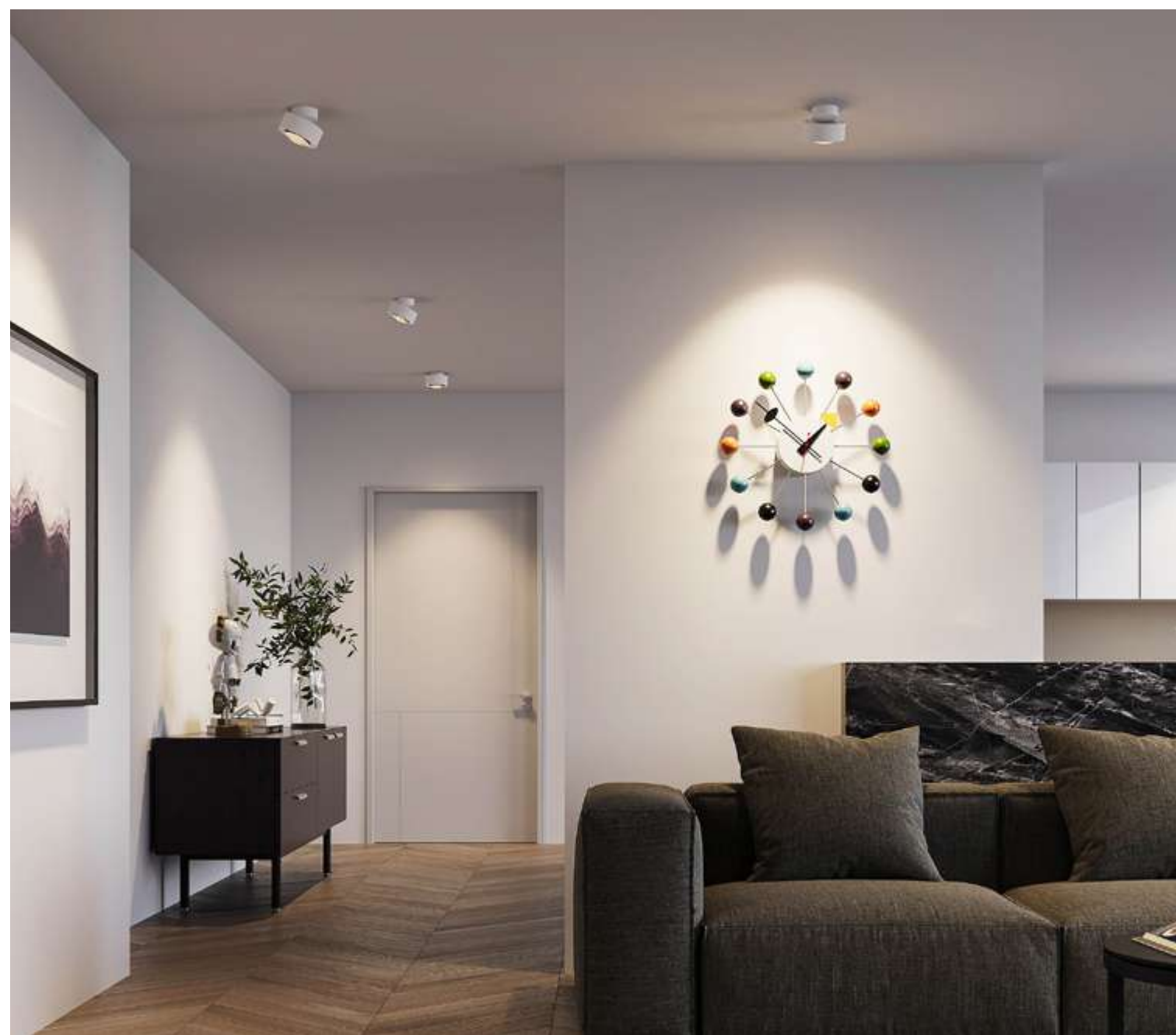





**MAGIS MINI SD**



ART. NR./CODE	LEISTUNG/POWER	LUMEN	CRI>	KELVIN	Ø x H	FARBE/COLOUR	REFL.	PREIS/PRICE
222-00040	SYS 12W	800	90	2700	75 x 92	white	46°	179,00
222-00041	SYS 12W	800	90	3000	75 x 92	white	46°	179,00
222-00042	SYS 12W	800	90	2700	75 x 92	black	46°	179,00
222-00043	SYS 12W	800	90	3000	75 x 92	black	46°	179,00

**MAGIS MINI DOUBLE SD**



ART. NR./CODE	LEISTUNG/POWER	LUMEN	CRI>	KELVIN	Ø x H	FARBE/COLOUR	REFL.	PREIS/PRICE
222-00044	SYS 20W	1500	90	2700	160 x 75 x 92	white	46°	269,00
222-00045	SYS 20W	1620	90	3000	160 x 75 x 92	white	46°	269,00
222-00046	SYS 20W	1500	90	2700	160 x 75 x 92	black	46°	269,00
222-00047	SYS 20W	1620	90	3000	160 x 75 x 92	black	46°	269,00

90° 350° IP20 IK02 DALI UGR<19

Aufbauleuchte, Aluminiumdruckguss, pulverbeschichtet, Dekorring wechselbar, beiliegender Austauschreflektor, Ausstrahlwinkel 23/34/46°

Surface-mounted luminaire, die-cast aluminium, powder-coated, replaceable decorative ring, enclosed replacement reflector, 23/34/46° beam angle



Dekorring  
Decoration ring



**MAGIS MINI DEKORRING/DECORATION RING**

ART. NR./CODE	FARBE/COLOUR	PREIS/PRICE
276-7007	gold	10,10
276-7008	white	10,10
276-7009	black	10,10



**MAGIS MINI TAUSCHREFLEKTOR/REPLACEMENT REFLECTORREFLECTOR**

ART. NR./CODE	REF	PREIS/PRICE
276-7012	23°	7,90
276-7013	34°	7,90







**MAGIS SD**

ART. NR./CODE	LEISTUNG/POWER	LUMEN	CRI>	KELVIN	Ø x H	FARBE/COLOUR	REFL.	PREIS/PRICE
222-00029	SYS 16W	1090	90	2700	100 x 103	white	36°	259,00
222-00030	SYS 16W	1150	90	3000	100 x 103	white	36°	259,00
222-00031	SYS 16W	1090	90	2700	100 x 103	black	36°	259,00
222-00032	SYS 16W	1150	90	3000	100 x 103	black	36°	259,00

**MAGIS DOUBLE SD**

ART. NR./CODE	LEISTUNG/POWER	LUMEN	CRI>	KELVIN	Ø x H	FARBE/COLOUR	REFL.	PREIS/PRICE
222-00033	SYS 29W	1940	90	2700	212 x 100 x 103	white	36°	399,00
222-00034	SYS 29W	2110	90	3000	212 x 100 x 103	white	36°	399,00
222-00035	SYS 29W	1940	90	2700	212 x 100 x 103	black	36°	399,00
222-00036	SYS 29W	2110	90	3000	212 x 100 x 103	black	36°	399,00



Dekorring  
Decoration ring

Aufbauleuchte, Aluminiumdruckguss, pulverbeschichtet, Dekorring wechselbar, beiliegender Austauschreflektor, Ausstrahlwinkel 20/30/36°

Surface-mounted luminaire, die-cast aluminium, powder-coated, replaceable decorative ring, enclosed replacement reflector, 20/30/36° beam angle



**MAGIS DEKORRING/DECORATION RING**

ART. NR./CODE	FARBE/COLOUR	PREIS/PRICE
276-7004	gold	12,20
276-7005	white	12,20
276-7006	black	12,20



**MAGIS TAUSCHREFLEKTOR/REPLACEMENT REFLECTOR**

ART. NR./CODE	REF	PREIS/PRICE
276-7010	20°	15,90
276-7011	30°	15,90











Aufbaustrahler, Aluminiumdruckguss, Feinstruktur matt pulverbeschichtet, Dekorring aus Kunststoff schwarz, Strahlerkopf 90° schwenk- und 355° drehbar, Wand- oder Deckenmontage, inkl. Konverter

Surface mounted spotlight, die-cast aluminium, powder-coated, decoration ring in black synthetic, head 90° tilting and 355° swiveling, wall or ceiling mounting, incl. driver

**MISSOR I**



ART. NR./CODE	LEISTUNG/POWER	LUMEN	CRI>	KELVIN	L x B x H/L x W x H	FARBE/COLOUR	REFL.	PREIS/PRICE
276-06290560	SYS 12W	660	90	3000	175 x 60 x 148	white	33°	179,00
276-0629060	SYS 12W	660	90	3000	175 x 60 x 148	black	33°	179,00



Aufbaustrahler, 2 flammig, Aluminiumdruckguss, Feinstruktur matt pulverbeschichtet, Dekorring aus Kunststoff schwarz, Strahlerkopf 90° schwenk- und 355° drehbar, Wand- oder Deckenmontage, inkl. Konverter

Surface mounted spotlight, 2-spots, die-cast aluminium, powder-coated, decoration ring in black synthetic, head 90° tilting and 355° swiveling, wall or ceiling mounting, incl. driver

**MISSOR II**



ART. NR./CODE	LEISTUNG/POWER	LUMEN	CRI>	KELVIN	L x B x H/L x W x H	FARBE/COLOUR	REFL.	PREIS/PRICE
276-07290560	SYS 21W	1340	90	3000	336 x 60 x 148	white	33°	299,00
276-0729060	SYS 21W	1340	90	3000	336 x 60 x 148	black	33°	299,00



Dekorring  
Decoration ring

**MISSOR DEKORRING/DECORATION RING**

ART. NR./CODE	Ø	FARBE/COLOUR	PREIS/PRICE
276-7000	60	gold	6,90
276-7001	60	white	6,90
222-A00021	60	black	6,90

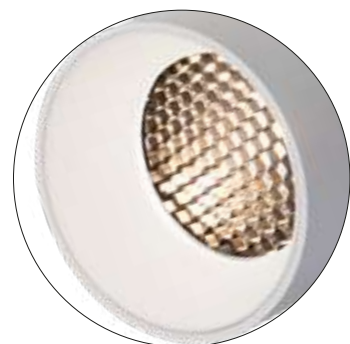

**MISSOR WABENRASTER/  
HONEY COMB LOUVRE**



ART. NR./CODE	Ø	FARBE/COLOUR	PREIS/PRICE
276-1002	60	black	4,80

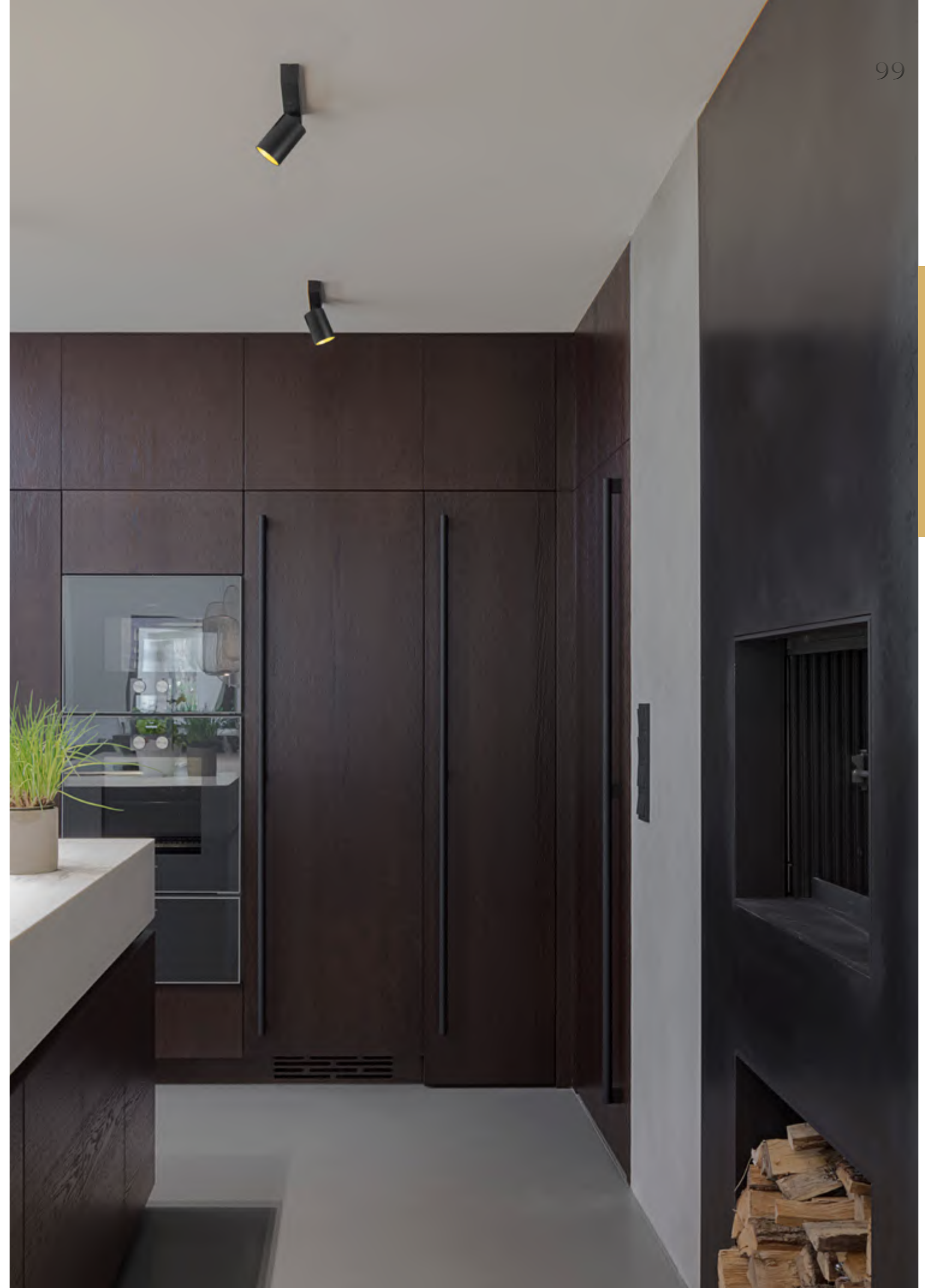





NEW

Aufbauleuchte, Aluminiumdruckguss, pulverbeschichtet, 3 Ausführungen

Surface-mounted luminaire, die-cast aluminium, powder-coated, 3 versions

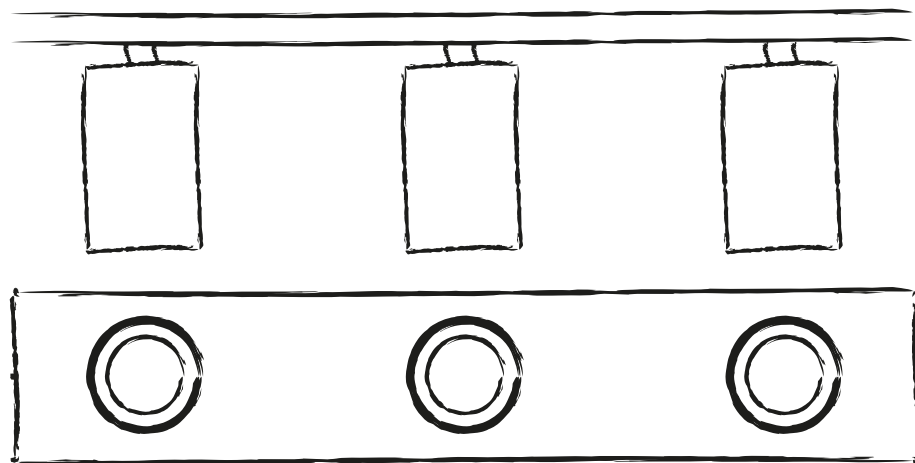

Dekorring/  
decoration ring



**MISSOR I SD GU10**

ART. NR./CODE	LM/BULB	FASSUNG/SOCKET	V AC	L x B x H/L x W x H	FARBE/COLOUR	PREIS/PRICE
222-00021	RETROFIT	GU10	230	110 x 90 x 125	☐ white	49,00
222-00022	RETROFIT	GU10	230	110 x 90 x 125	■ black	49,00



**MISSOR II SD GU10**

ART. NR./CODE	LM/BULB	FASSUNG/SOCKET	V AC	L x B x H/L x W x H	FARBE/COLOUR	PREIS/PRICE
222-00023	RETROFIT	GU10	230	305 x 90 x 125	☐ white	89,00
222-00024	RETROFIT	GU10	230	305 x 90 x 125	■ black	89,00



**MISSOR III SD GU10**

ART. NR./CODE	LM/BULB	FASSUNG/SOCKET	V AC	L x B x H/L x W x H	FARBE/COLOUR	PREIS/PRICE
222-00025	RETROFIT	GU10	230	480 x 90 x 125	☐ white	139,00
222-00026	RETROFIT	GU10	230	480 x 90 x 125	■ black	139,00



**MISSOR DEKORRING/DECORATION RING**

ART. NR./CODE	INFORMATION	FARBE/COLOUR	PREIS/PRICE
276-7000	Ring aus Kunststoff, gold, weiß oder schwarz werkzeuglos wechselbar (separat ordern)	■ gold	6,90
276-7001	Syntetic decoration ring, gold, white or black, changeable without tools (order separately)	☐ white	6,90
222-A00021		■ black	6,90

**LEUCHTMITTEL/LIGHT SOURCE**

Weitere Leuchtmittel S./additional light sources P. 290

ART. NR./CODE	INFORMATION	PREIS/PRICE
30-752517	Core Pro LED Spot, GU10,5W, 827 Kelvin	6,50







NEW

**QANA ROUND SD**

ART. NR./CODE	LM/BULB	FASSUNG/SOCKET	V AC	Ø x H	FARBE/COLOUR	PREIS/PRICE
222-00009	RETROFIT	GU10	230	94 x 94	☐ white	69,00
222-00010	RETROFIT	GU10	230	94 x 94	■ black	69,00



NEW

**QANA BOX 1 SD**

ART. NR./CODE	LM/BULB	FASSUNG/SOCKET	V AC	L x B x H/L x W x H	FARBE/COLOUR	PREIS/PRICE
222-00011	RETROFIT	GU10	230	94 x 94 x 94	☐ white	74,00
222-00012	RETROFIT	GU10	230	94 x 94 x 94	■ black	74,00



NEW

**QANA BOX 2 SD**

ART. NR./CODE	LM/BULB	FASSUNG/SOCKET	V AC	L x B x H/L x W x H	FARBE/COLOUR	PREIS/PRICE
222-00013	RETROFIT	GU10	230	187 x 94 x 94	☐ white	134,00
222-00014	RETROFIT	GU10	230	187 x 94 x 94	■ black	134,00

**LEUCHTMITTEL/LIGHT SOURCE**

Weitere Leuchtmittel S./additional light sources P. 290

ART. NR./CODE	INFORMATION	PREIS/PRICE
30-752517	Core Pro LED Spot, GU10, 5W, 827 Kelvin	6,50



# MUSO







Deckenaufbauleuchte, Polycarbonat, 3 Größen

**BWM:** Mit DIP-Switch zur Einstellung von Stand-By Zeit/Tageslichtsensor/Leuchtdauer und Bewegungsradius

Surface-mounted ceiling light, polycarbonate, 3 sizes **MD:** With dip switch for setting stand-by time/daylight sensor/light duration and movement radius

### MUSO ROUND SD

ART. NR./CODE	LEISTUNG/POWER	LUMEN	CRI>	KELVIN	Ø x H/Ø x H	FARBE/COLOUR	REFL.	PREIS/PRICE
501-r2819150	SYS 18W	1750	80	3000	280 x 48	white	115°	69,00
501-r3319150	SYS 24W	2270	80	3000	330 x 48	white	115°	99,00
501-r4019150	SYS 36W	3200	80	3000	400 x 48	white	115°	129,00



NEW

### MUSO ROUND SD SENSOR

ART. NR./CODE	LEISTUNG/POWER	LUMEN	CRI>	KELVIN	Ø x H/Ø x H	FARBE/COLOUR	REFL.	PREIS/PRICE
222-00056	SYS 18W	1820	80	3000/4000	280 x 53	white	115°	99,00
222-00058	SYS 24W	2880	80	3000/4000	330 x 53	white	115°	119,00



NEW

### MUSO ROUND SD DALI

ART. NR./CODE	LEISTUNG/POWER	LUMEN	CRI>	KELVIN	Ø x H/Ø x H	FARBE/COLOUR	REFL.	PREIS/PRICE
222-00055	SYS 18W	1980	80	3000/4000	280 x 58	white	115°	119,00
222-00057	SYS 24W	2640	80	3000/4000	330 x 58	white	115°	139,00



IP54 IK08  

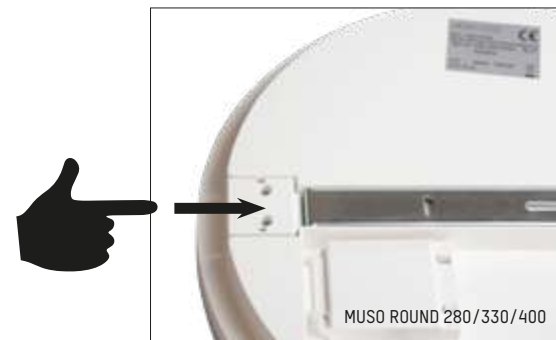

Bei allen Größen erfolgt die Montage der Leuchte an der Grundplatte mittels Montag-eclip. Eine Aussparung für seitliche Kabelein-führung ist vorhanden.

For all sizes, the luminaire is mounted to the bracket through a mounting clip. A recess for lateral cable entry is existing.



**BWM:** Der Bewegungsmelder ist seitlich hinter einer Abdeckung einstellbar.

The motion detector is adjustable on the side behind a cover.







Deckenaufbauleuchte, Polycarbonat, 3 Größen

**BWM:** Mit DIP-Switch zur Einstellung von Stand-By Zeit/Tageslichtsensor/Leuchtdauer und Bewegungsradius

Surface-mounted ceiling light, polycarbonate, 3 sizes

**MD:** With dip switch for setting stand-by time/daylight sensor/light duration and movement radius

### MUSO SQUARE SD

ART. NR./CODE	LEISTUNG/POWER	LUMEN	CRI>	KELVIN	L x B x H/L x W x H	FARBE/COLOUR	PREIS/PRICE
501-q2819150	SYS 18W	1750	80	3000	280 x 280 x 48	white	69,00
501-q3319150	SYS 24W	2270	80	3000	330 x 330 x 48	white	99,00
501-q4019150	SYS 36W	3200	80	3000	400 x 400 x 48	white	129,00



NEW

### MUSO SQUARE SD SENSOR

ART. NR./CODE	BMW/MD	LEISTUNG/POWER	LUMEN	CRI>	KELVIN	L x B x H/L x W x H	FARBE/COLOUR	PREIS/PRICE
222-00062	X	SYS 18W	1820	80	3000/4000	280 x 280 x 53	white	99,00
222-00064	X	SYS 24W	2485	80	3000/4000	330 x 330 x 53	white	119,00



IP54 IK08 A G D



MUSO SQUARE 280/330/400

Bei den Größen 280 & 330 erfolgt die Montage der Leuchte an der Grundplatte mittels Montageclip. Bei der Größe 400 ist die Montage verschraubt. Eine Aussparung für seitliche Kabeleinführung ist vorhanden.

For all sizes 280 & 330, the luminaire is mounted to the bracket through a mounting clip. For size 400 the luminaire is mounted on the bracket through screws. A recess for lateral cable entry is existing.



**BWM:** Der Bewegungsmelder ist seitlich hinter einer Abdeckung einstellbar.

The motion detector is adjustable on the side behind a cover.

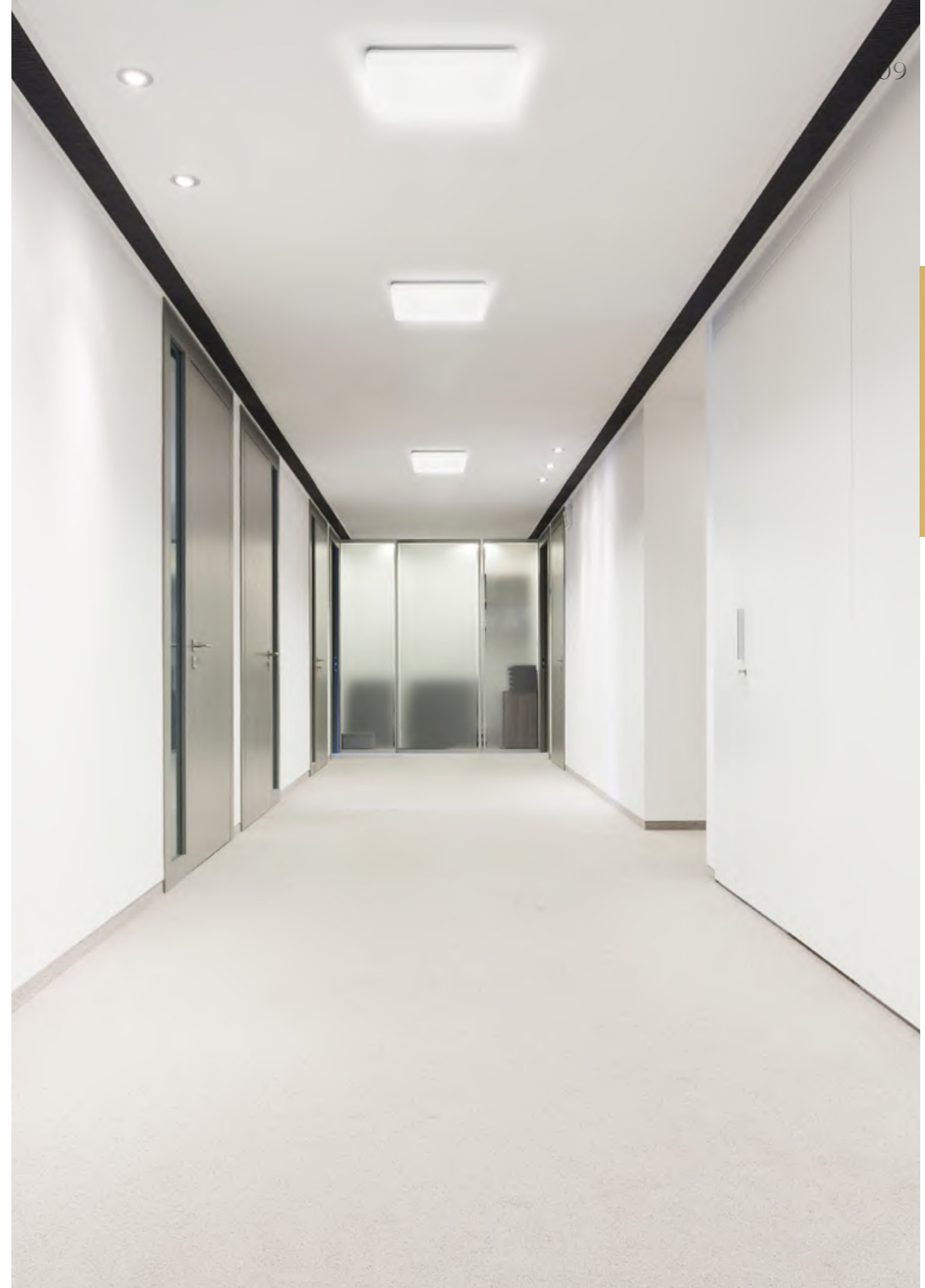



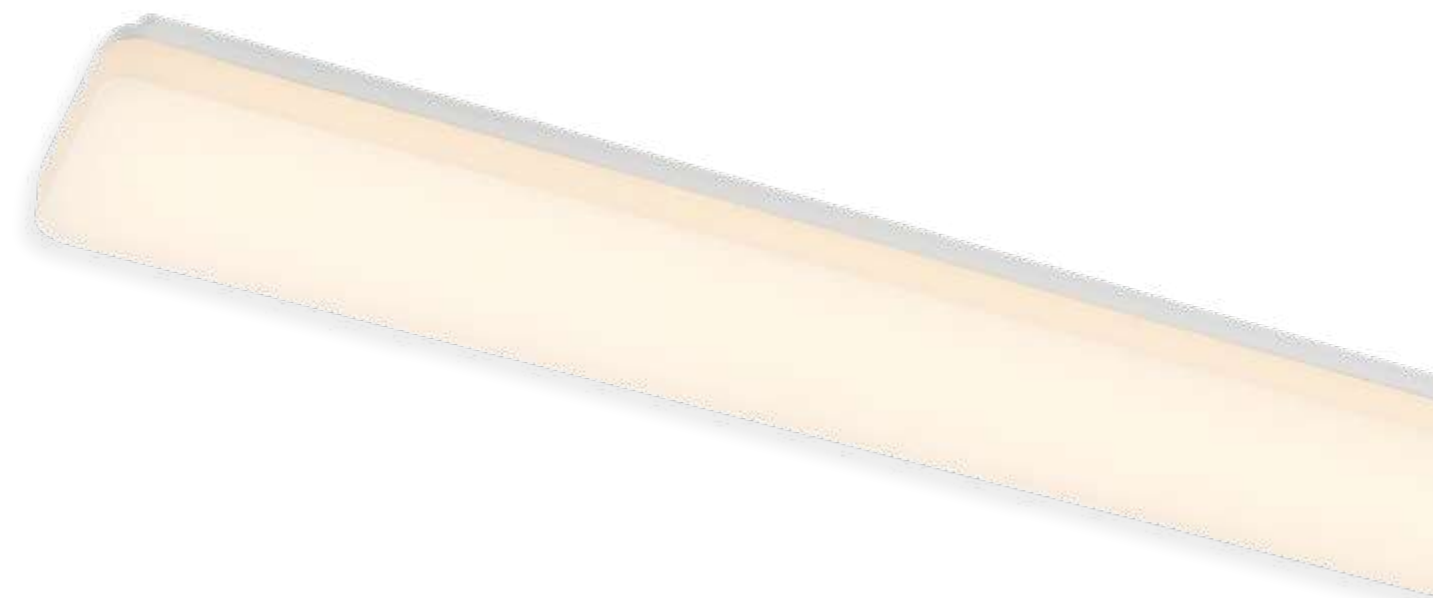

Deckenaufbauleuchte, Polycarbonat Abdeckung Ausstrahlwinkel 120°, Durchgangsverdrahtung möglich, IP54, auch als Variante DALI dimmbar verfügbar

Surface-mounted ceiling light, polycarbonate cover Beam angle 120°, through-wiring possible, IP54, also available as a DALI dimmable

NEW

### MUSO LINEAR SD

ART. NR./CODE	LEISTUNG/POWER	LUMEN	CRI>	KELVIN	L x B x H/L x W x H	FARBE/COLOUR	REFL.	PREIS/PRICE
222-00066	SYS 18W	2450/2560	80	3000/4000	600 x 140 x 52	white	120°	119,00
222-00067	SYS 36W	4980/5260	80	3000/4000	1200 x 140 x 52	white	120°	189,00

IP54 IK08  



NEW

### MUSO 120 LINEAR CCT DALI

ART. NR./CODE	LEISTUNG/POWER	LUMEN	CRI>	KELVIN	L x B x H/L x W x H	FARBE/COLOUR	REFL.	PREIS/PRICE
222-00059	SYS 36W	4980/5260	80	3000/4000	1200 x 140 x 59	white	115°	239,00

IP54 IK08   







Aufbauleuchte, Sockel aus Stahlblech, pulverbeschichtet weiß, mundgeblasenes Dreischichtglas TRIPLEX opal matt, Schirmbefestigung mittels Klappfedern

Surface-mounted luminaire, base made of sheet steel, powder-coated white, hand-blown TRIPLEX opal matt three-layer glass, shade fastening with hinged springs



### ALKOR 2 E27

ART. NR./CODE	LM/BULB	FASSUNG/SOCKET	V AC	Ø x H	SOCKEL/SOCKET	FARBE/COLOUR	PREIS/PRICE
789-52162	RETROFIT	E27	230	104 x 156	Ø 120	□ white	97,40



Aufbauleuchte, Sockel aus Stahlblech, pulverbeschichtet weiß, mundgeblasenes Dreischichtglas TRIPLEX opal matt, Schirmbefestigung mittels Klappfedern

Surface-mounted luminaire, base made of sheet steel, powder-coated white, hand-blown TRIPLEX opal matt three-layer glass, shade fastening with hinged springs



### APUS E27

ART. NR./CODE	LM/BULB	FASSUNG/SOCKET	V AC	L x B x H/L x W x H	SOCKEL/SOCKET	FARBE/COLOUR	PREIS/PRICE
789-52160	RETROFIT	E27	230	140 x 140 x 156	Ø 120	□ white	113,30
789-52161	RETROFIT	E27	230	184 x 184 x 200	Ø 160	□ white	148,30
789-71277	RETROFIT	E27	230	230 x 230 x 250	Ø 200	□ white	303,90



### AUFBAUGEHÄUSE/SURFACE HOUSING



ART. NR./CODE	INFO	L x B x H/L x W x H	FARBE/COLOUR	PREIS/PRICE
789-33510	dekorative Abdeckung aus Metall - nur passend für Apus 184 x 184mm/ Decorative metal cover - only suitable for Apus 184 x 184mm	235 x 184 x 184	■ black	41,30



Wand-/ Deckenleuchte, Trägerplatte Stahlblech, weiß lackiert, Abdeckung, mundgeblasenes Dreischichtglas Triplex-Opal mit mattierter Oberfläche, Bajonettverschluss

Wall/ceiling light, support plate sheet steel, painted white, cover, hand-blown three-layer glass triplex opal with frosted surface, bayonet catch



### ELSA E27

ART. NR./CODE	LM/BULB	FASSUNG/SOCKET	V AC	Ø x H	SOCKEL/SOCKET	FARBE/COLOUR	PREIS/PRICE
789-44705	2x RETROFIT	E27	230	250 x 84	Ø 205	□ white	93,20
789-44741	2x RETROFIT	E27	230	300 x 86	Ø 250	□ white	112,30
789-44900	2x RETROFIT	E27	230	420 x 90	Ø 345	□ white	255,20



### LEUCHTMITTEL/LIGHT SOURCE

Weitere Leuchtmittel S./additional light sources P. 290

ART. NR./CODE	INFORMATION	PREIS/PRICE
30-449718	A60/MASTER VLE LED Bulb clear, E27,6W, 922-927 Kelvin	12,70







Wand-/ Deckenleuchte, Trägerplatte Stahlblech, weiß lackiert, opale Polycarbonat-Abdeckung, Schirmbefestigung mittels Klappfedern,  
**BWM:** mit Bewegungsmelder 1 - 5m  
 Versionen mit Glasabdeckung auf Anfrage

Wall/ceiling light, support plate Sheet steel, painted white, opal polycarbonate cover, shade fastened using hinged springs,  
**MD:** with motion detector 1 - 5m  
 Versions with glass cover on request



### DELIA E27

ART. NR./CODE	LM/BULB	BWM/MD	FASSUNG/SOCKET	V AC	Ø x H	SOCKEL/SOCKET	FARBE/COLOUR	PREIS/PRICE
789-52112	RETROFIT	---	E27	230	220 x 70	Ø 200	<input type="checkbox"/> white	72,00
789-56075	RETROFIT	---	E27	230	300 x 75	Ø 275	<input type="checkbox"/> white	80,50
789-56079	RETROFIT	X	E27	230	300 x 75	Ø 275	<input type="checkbox"/> white	131,30
789-52560	2x RETROFIT	---	E27	230	360 x 71	Ø 342	<input type="checkbox"/> white	105,90
789-56110	2x RETROFIT	---	E27	230	400 x 80	Ø 375	<input type="checkbox"/> white	115,40
789-56116	2x RETROFIT	X	E27	230	400 x 80	Ø 375	<input type="checkbox"/> white	159,90
789-56130	3x RETROFIT	---	E27	230	500 x 85	Ø 465	<input type="checkbox"/> white	147,20
789-56137	3x RETROFIT	X	E27	230	500 x 85	Ø 465	<input type="checkbox"/> white	197,00



### LEUCHTMITTEL/LIGHT SOURCE

Weitere Leuchtmittel S./additional light sources P. 290

ART. NR./CODE	INFORMATION	PREIS/PRICE
30-449718	A60/MASTER VLE LED Bulb clear, E27,6W, 922-927 Kelvin	12,70



Wand-/ Deckenleuchte, Trägerplatte Stahlblech, weiß lackiert, opale Polycarbonat-Abdeckung oder PMMA-Abdeckung, Schirmbefestigung mittels Klappfedern, inkl. Konverter  
**BWM:** mit Bewegungsmelder 1 - 5m

Wall/ceiling light, support plate sheet steel, painted white, opal polycarbonate cover or PMMA cover, shade cover, shade fastening by means of hinged springs, incl. converter  
**MD:** with motion detector 1 - 5m



### DELIA

ART. NR./CODE	LEISTUNG/POWER	BWM/MD	LUMEN	CRI>	KELVIN	Ø x H	SOCKEL/SOCKET	FARBE/COLOUR	PREIS/PRICE
789-56275	SYS 5W	---	460	80	3000	140 x 65	120	<input type="checkbox"/> white	123,90
789-56775	SYS 5W	---	480	80	4000	140 x 65	120	<input type="checkbox"/> white	123,90
789-56282	SYS 11W	---	950	80	3000	220 x 70	200	<input type="checkbox"/> white	127,10
789-56782	SYS 11W	---	1000	80	4000	220 x 70	200	<input type="checkbox"/> white	127,10
789-56290	SYS 15W	---	1480	80	3000	300 x 75	275	<input type="checkbox"/> white	164,10
789-56291	SYS 15W	X	1480	80	3000	300 x 75	275	<input type="checkbox"/> white	209,70
789-56790	SYS 15W	---	1560	80	4000	300 x 75	275	<input type="checkbox"/> white	164,10
789-53316	SYS 20W	---	1920	80	3000	300 x 75	275	<input type="checkbox"/> white	172,60
789-53816	SYS 20W	---	2000	80	4000	300 x 75	275	<input type="checkbox"/> white	172,60
789-67200	SYS 19W	---	1750	80	3000	360 x 71	342	<input type="checkbox"/> white	225,60
789-67700	SYS 19W	---	1830	80	4000	360 x 71	342	<input type="checkbox"/> white	225,60
789-67206	SYS 27W	---	2350	80	3000	360 x 71	342	<input type="checkbox"/> white	231,90
789-56300	SYS 29W	---	2580	80	3000	400 x 80	375	<input type="checkbox"/> white	240,40
789-56301	SYS 29W	X	2580	80	3000	400 x 80	375	<input type="checkbox"/> white	271,10
789-53337	SYS 33W	---	3400	80	3000	400 x 80	375	<input type="checkbox"/> white	240,40
789-53837	SYS 36W	---	3550	80	4000	400 x 80	375	<input type="checkbox"/> white	240,40

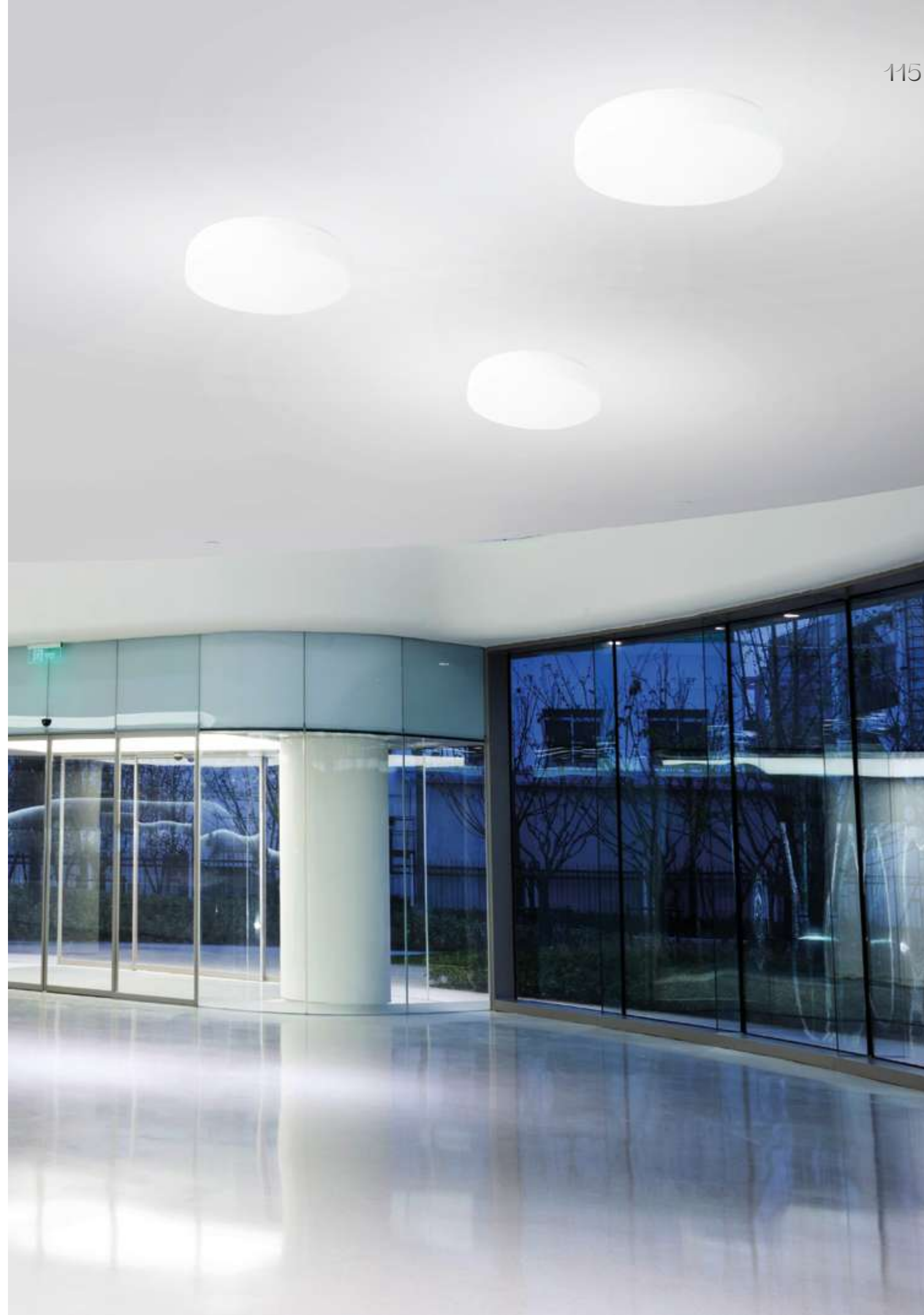
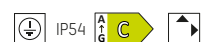





Wand-/ Deckenleuchte, Trägerplatte Stahlblech, weiß lackiert, mundgeblasenes Dreischichtglas TRIPLEX opal matt, Halterung mittels Bajonettverschluss

Wall/ceiling light, support plate sheet steel, painted white, hand-blown TRIPLEX opal three-layer glass matt, bracket with bayonet catch



### AURA E27

ART. NR./CODE	LM/BULB	FASSUNG/SOCKET	V AC	Ø x H	SOCKEL/SOCKET	FARBE/COLOUR	PREIS/PRICE
789-42702	RETROFIT	E27	230	200 x 105	Ø 170	<input type="checkbox"/> white	81,50
789-42703	RETROFIT	E27	230	250 x 110	Ø 205	<input type="checkbox"/> white	91,10
789-42709	2x RETROFIT	E27	230	300 x 115	Ø 250	<input type="checkbox"/> white	108,00
789-42742	2x RETROFIT	E27	230	360 x 125	Ø 290	<input type="checkbox"/> white	150,40
789-42775	2x RETROFIT	E27	230	420 x 125	Ø 345	<input type="checkbox"/> white	216,00



IP44



Wand-/ Deckenleuchte, Trägerplatte Stahlblech, weiß lackiert, Polycarbonat Abdeckung weiß satiniert, Halterung mittels Bajonettverschluss

Wall/ceiling light, support plate Sheet steel, painted white, polycarbonate cover satined white, bracket with bayonet catch



### TITAN E27

ART. NR./CODE	LM/BULB	FASSUNG/SOCKET	V AC	Ø x H	SOCKEL/SOCKET	FARBE/COLOUR	PREIS/PRICE
789-56050	RETROFIT	E27	230	220 x 100	Ø 170	<input type="checkbox"/> white	72,00
789-56000	RETROFIT	E27	230	300 x 105	Ø 275	<input type="checkbox"/> white	81,50
789-56012	2x RETROFIT	E27	230	400 x 115	Ø 375	<input type="checkbox"/> white	115,40
789-56024	3x RETROFIT	E27	230	500 x 130	Ø 465	<input type="checkbox"/> white	147,20
789-56056	4x RETROFIT	E27	230	650 x 150	Ø 625	<input type="checkbox"/> white	265,80
789-56061	6x RETROFIT	E27	230	900 x 200	Ø 875	<input type="checkbox"/> white	447,60



IP44



### LEUCHTMITTEL/LIGHT SOURCE

Weitere Leuchtmittel S./additional light sources P. 290

ART. NR./CODE	INFORMATION	PREIS/PRICE
30-449718	A60/MASTER VLE LED Bulb clear, E27,6W, 922-927 Kelvin	12,70







Wand-/ Deckenleuchte, Trägerplatte Stahlblech weiß, mundgeblasenes Dreischichtglas TRIPLEX opal matt, Schirmbefestigung mittels Klappfedern

wall/ceiling light, white sheet steel support plate, hand-blown TRIPLEX opal matt three-layer glass, shade fastening by means of hinged springs

### LINA E27

ART. NR./CODE	LM/BULB	FASSUNG/SOCKET	V AC	L x B x H/L x W x H	SOCKEL/SOCKET	FARBE/COLOUR	PREIS/PRICE
789-41252	RETROFIT	E27	230	200 x 200 x 105	Ø 175	<input type="checkbox"/> white	104,80
789-41262	RETROFIT	E27	230	200 x 200 x 105	Ø 175	<input type="checkbox"/> white	104,80
789-41270	2x RETROFIT	E27	230	260 x 260 x 110	Ø 230	<input type="checkbox"/> white	133,40
789-41307	2x RETROFIT	E27	230	320 x 320 x 115	Ø 275	<input type="checkbox"/> white	245,70
789-42310	2x RETROFIT	E27	230	380 x 380 x 120	Ø 325	<input type="checkbox"/> white	271,10



Wand-/ Deckenleuchte, Trägerplatte Stahlblech, weiß lackiert, opale Polycarbonatabdeckung, Schirmbefestigung mittels Klappfedern **BWM:** mit Bewegungsmelder 1 - 5m

Wall/ceiling light, support plate Sheet steel, painted white, opal polycarbonate cover, shade fastening by means of hinged springs **MD:** with motion detector 1 - 5m

### TILIA E27

ART. NR./CODE	LM/BULB	BWM/MD	FASSUNG/SOCKET	V AC	L x B x H/L x W x H	SOCKEL L x B/SOCKET L x W	FARBE/COLOUR	PREIS/PRICE
789-52120	RETROFIT	---	E27	230	220 x 220 x 70	200 x 200	<input type="checkbox"/> white	77,30
789-56155	2x RETROFIT	---	E27	230	300 x 300 x 70	270 x 270	<input type="checkbox"/> white	100,10
789-56159	2x RETROFIT	X	E27	230	300 x 300 x 70	270 x 270	<input type="checkbox"/> white	164,10
789-52575	2x RETROFIT	---	E27	230	360 x 360 x 70	337 x 337	<input type="checkbox"/> white	132,40
789-56171	3x RETROFIT	---	E27	230	400 x 400 x 70	400 x 400	<input type="checkbox"/> white	140,80
789-52121	4x RETROFIT	---	E27	230	550 x 550 x 70	550 x 550	<input type="checkbox"/> white	239,30



### LEUCHTMITTEL/LIGHT SOURCE

Weitere Leuchtmittel S./additional light sources P. 290

ART. NR./CODE	INFORMATION	PREIS/PRICE
30-449718	A60/MASTER VLE LED Bulb clear, E27,6W, 922-927 Kelvin	12,70







Kugelleuchte, opale PMMA-Abdeckung matt satiniert, Kabelaufhängung, auf Anfrage Abhängung mit Stahlseil und Kabel bzw. starrem Pendel aus Aluminium erhältlich

Spherical luminaire, opal PMMA cover, matt satin finish, cable suspension, suspension with steel cable and aluminium cable or rigid pendant available on request.



### ISIS E27



ART. NR./CODE	LM/BULB	FASSUNG/SOCKET	V AC	Ø	ABHÄNG./SUSP.	FARBE/COLOUR	FARBE ABDECKUNG/COLOUR COVER	PREIS/PRICE
789-63805	RETROFIT	E27	230	300	2000	<input type="checkbox"/> white	<input type="checkbox"/> white	213,90
789-63806	RETROFIT	E27	230	300	2000	<input type="checkbox"/> white	<input checked="" type="checkbox"/> black	213,90
789-63810	RETROFIT	E27	230	400	2000	<input type="checkbox"/> white	<input type="checkbox"/> white	282,80
789-63811	RETROFIT	E27	230	400	2000	<input type="checkbox"/> white	<input checked="" type="checkbox"/> black	282,80
789-63815	RETROFIT	E27	230	500	2000	<input type="checkbox"/> white	<input type="checkbox"/> white	349,50
789-63816	RETROFIT	E27	230	500	2000	<input type="checkbox"/> white	<input checked="" type="checkbox"/> black	349,50



IP40

### LEUCHTMITTEL/LIGHT SOURCE

Weitere Leuchtmittel S./additional light sources P. 290

ART. NR./CODE	INFORMATION	PREIS/PRICE
30-380035	A60/CorePro LED Bulb clear, E27,7W, 827 Kelvin	4,90





# WANDLEUCHTEN WALLLAMPS







LED Aufbauleuchte aus Aluminium, matt Feinstruktur pulverbeschichtet, direkt/indirekt breitstrahlend, inkl. Konverter

Wall luminaire, aluminium, powder-coated, direct/indirect beam, incl. driver

### FORO SHORT W



ART. NR./CODE	LEISTUNG/POWER	LUMEN	CRI>	KELVIN	L x B x H/L x W x H	FARBE/COLOUR	PREIS/PRICE
341-40003440	SYS 4W	260	90	2700	70 x 60 x 75	silver	79,00
341-40003550	SYS 4W	260	90	2700	70 x 60 x 75	white	79,00
341-40009440	SYS 4W	260	90	3000	70 x 60 x 75	silver	79,00
341-40009550	SYS 4W	260	90	3000	70 x 60 x 75	white	79,00



LED Aufbauleuchte aus Aluminium, matt Feinstruktur pulverbeschichtet, direkt/indirekt breitstrahlend, inkl. Konverter

Wall luminaire, aluminium, powder-coated, direct/indirect beam, incl. driver

### FORO LONG W



ART. NR./CODE	LEISTUNG/POWER	LUMEN	CRI>	KELVIN	L x B x H/L x W x H	FARBE/COLOUR	PREIS/PRICE
341-40013440	SYS 11W	935	90	2700	300 x 70 x 100	silver	199,00
341-40013550	SYS 11W	935	90	2700	300 x 70 x 100	white	199,00
341-40019440	SYS 11W	950	90	3000	300 x 70 x 100	silver	244,80
341-40019550	SYS 11W	950	90	3000	300 x 70 x 100	white	199,00

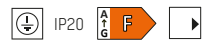





Wandleuchte, Aluminium lackiert oder pulverbeschichtet, direkt/indirekt breitstrahlend, inkl. Konverter

Wall luminaire, aluminium, brushed or powder-coated, direct/indirect beam, incl. driver

## NOVEL



ART. NR./CODE	LEISTUNG/POWER	LUMEN	CRI>	KELVIN	L x B x H/L x W x H	FARBE/COLOUR	PREIS/PRICE
472-3927050	SYS 8W	360	90	2700	100 x 100 x 100	white	189,00
472-3927060	SYS 8W	130	90	2700	100 x 100 x 100	black	189,00
472-39270630	SYS 8W	190	90	2700	100 x 100 x 100	black/gold	229,00
472-39270140	SYS 8W	260	90	2700	100 x 100 x 100	alu brushed	189,00
472-3929050	SYS 8W	400	90	3000	100 x 100 x 100	white	189,00
472-3929060	SYS 8W	145	90	3000	100 x 100 x 100	black	189,00
472-39290630	SYS 8W	210	90	3000	100 x 100 x 100	black/gold	229,00
472-39290140	SYS 8W	290	90	3000	100 x 100 x 100	alu brushed	189,00

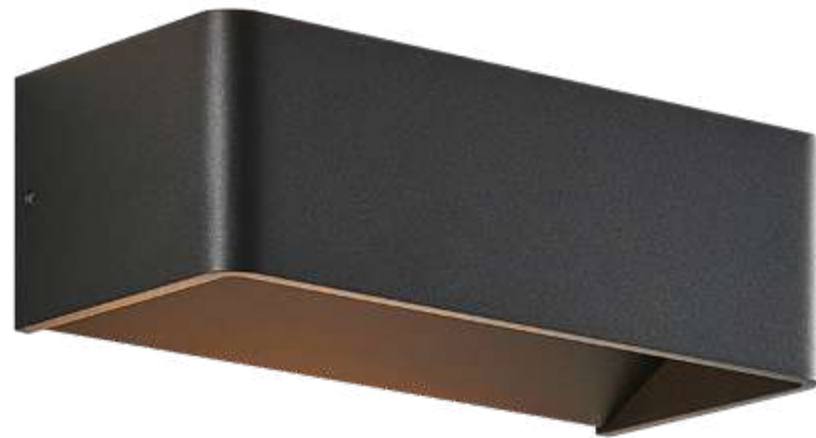
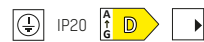

Wandleuchte, Aluminium, pulverbeschichtet oder lackiert, direkt/indirekt breitstrahlend, inkl. Konverter

Wall luminaire, aluminium, brushed or powder-coated, direct/indirect beam, incl. driver

## ALICA



ART. NR./CODE	LEISTUNG/POWER	LUMEN	CRI>	KELVIN	L x B x H/L x W x H	FARBE/COLOUR	PREIS/PRICE
472-0000790002705	SYS 7W	400	90	2700	200 x 100 x 70	white	199,00
472-0000790002706	SYS 7W	215	90	2700	200 x 100 x 70	black	199,00
472-0000790002763	SYS 7W	305	90	2700	200 x 100 x 70	black/gold	239,00
472-0000790002714	SYS 7W	320	90	2700	200 x 100 x 70	alu brushed	199,00
472-0000790003005	SYS 7W	420	90	3000	200 x 100 x 70	white	199,00
472-0000790003006	SYS 7W	220	90	3000	200 x 100 x 70	black	199,00
472-0000790003063	SYS 7W	320	90	3000	200 x 100 x 70	black/gold	239,00
472-0000790003014	SYS 7W	330	90	3000	200 x 100 x 70	alu brushed	199,00







Wandleuchte, Aluminiumdruckguss, Feinstruktur matt pulverbeschichtet, direkt/indirekt strahlend, Leuchtenkopf 345° drehbar, inkl. Konverter

Wall luminaire, die-cast aluminium, powder-coated, direct/indirect beam, head 345° swiveling, incl. driver

### BO SINGLE

ART. NR./CODE	LEISTUNG/POWER	LUMEN	CRI>	KELVIN	L x B x H/L x W x H	FARBE/COLOUR	PREIS/PRICE
472-0827050	SYS 6W	285	90	2700	135 x 30 x 135	white	179,00
472-0827060	SYS 6W	175	90	2700	135 x 30 x 135	black	179,00

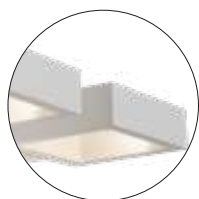

Wandleuchte, 2 flammig, Aluminiumdruckguss, Feinstruktur matt pulverbeschichtet, direkt/indirekt strahlend, Leuchtenköpfe 345° drehbar, inkl. Konverter

Wall luminaire, 2-spots, die-cast aluminium, powder-coated, direct/indirect beam, head 345° swiveling, incl. driver

### BO DOUBLE

ART. NR./CODE	LEISTUNG/POWER	LUMEN	CRI>	KELVIN	L x B x T/L x W x D	FARBE/COLOUR	PREIS/PRICE
472-0927050	SYS 2x 6W	565	90	2700	240 x 30 x 135	white	269,00
472-0927060	SYS 2x 6W	330	90	2700	240 x 30 x 135	black	269,00



Wandleuchte, Aluminium lackiert oder pulverbeschichtet, direkt/indirekt strahlend

Wall luminaire, aluminium, brushed or powder-coated, direct/indirect beam

### TAKE G9

ART. NR./CODE	LM/BULB	FASSUNG/SOCKET	V AC	L x B x T/L x W x D	FARBE/COLOUR	PREIS/PRICE
472-291009w	RETROFIT	G9	230	100 x 100 x 100	white	69,00
472-291009b	RETROFIT	G9	230	100 x 100 x 100	black	69,00
472-291009a	RETROFIT	G9	230	100 x 100 x 100	alu brushed	69,00



### LEUCHTMITTEL/LIGHT SOURCE

Weitere Leuchtmittel S./additional light sources P. 290

ART. NR./CODE	INFORMATION	PREIS/PRICE
30-657802	Core Pro LED Capsule, 69,5W, 827 Kelvin, nicht dimmbar/not dimmable	26,40

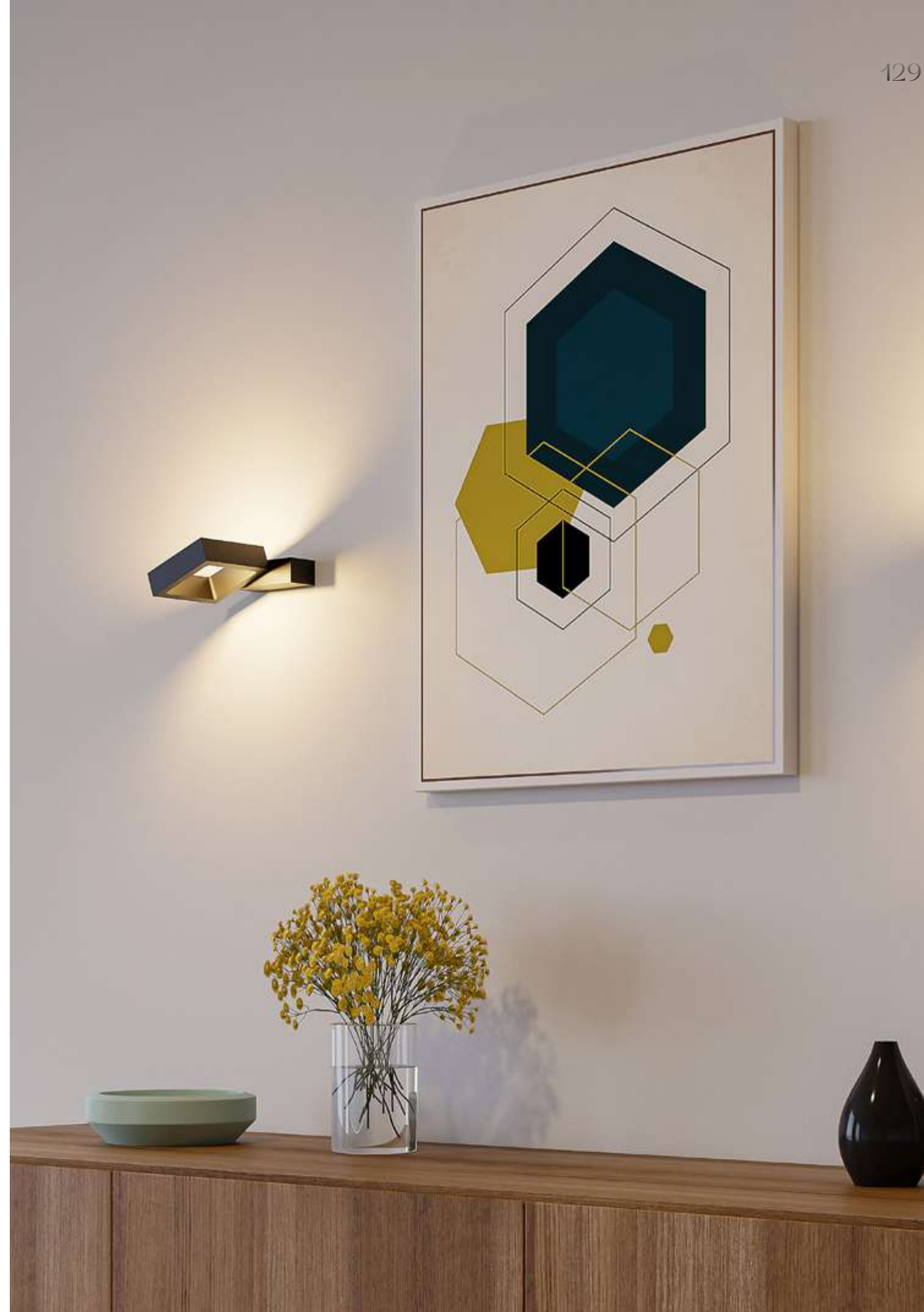





Wandaufbauleuchte, aus Aluminium, Lichtaustritt direkt, DIP-Switch

Surface-mounted wall light, made of aluminium, light emission direct, dipswitch

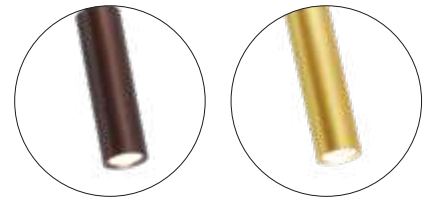

NEW

**AROK W**

ART. NR./CODE	LEISTUNG/POWER	LUMEN	CRI>	KELVIN	Ø x L x B x H/Ø x L x W x H	FARBE/COLOUR	PREIS/PRICE
222-00093	SYS 7W	255/280	90	2700/ 3000	26 x 35 x 30 x 180	black/black	169,00
222-00094	SYS 7W	255/280	90	2700/ 3000	26 x 35 x 30 x 180	black/gold	169,00
222-00095	SYS 7W	255/280	90	2700/ 3000	26 x 35 x 30 x 180	black/coffee	169,00



Wandaufbauleuchte, aus Aluminium, schwenkbar 90°, drehbar 350°, direkt/indirekt strahlend

Surface-mounted wall light, made of aluminium, swivelling 90°, rotatable 350°, direct/indirect distribution



**CLARUS**

ART. NR./CODE	LEISTUNG/POWER	LUMEN	CRI>	KELVIN	Ø x T/Ø x D	FARBE/COLOUR	REFL.	PREIS/PRICE
276-0151090402705tr	SYS 11W	400	90	2700	120 x 82	white	40°	269,00
276-0151090402706tr	SYS 11W	365	90	2700	120 x 82	black	40°	269,00
276-0151090402763tr	SYS 11W	365	90	2700	120 x 82	black/gold	40°	269,00





Spiegelleuchte mit zylindrischer Abdeckung, Diffusor aus satiniertem Polycarbonat, Trägerprofil und Enddeckel verchromt, Einspeisung mittig an der Leuchten-Rückseite.

Mirror light with cylindrical cover, diffuser made of satinised polycarbonate, support profile and end cap chrome-plated, power feed centred on the back of the light.

### SERIE 44 SHORT SD

ART. NR./CODE	LEISTUNG/POWER	LUMEN	CRI>	KELVIN	L x B x H/L x W x H	FARBE/COLOUR	REFL.	PREIS/PRICE
120-40079100	SYS 20W	1220	80	2700	528 x 93 x 55	white/chrome	---	149,00

### SERIE 44 LONG SD

ART. NR./CODE	LEISTUNG/POWER	LUMEN	CRI>	KELVIN	L x B x H/L x W x H	FARBE/COLOUR	REFL.	PREIS/PRICE
120-40089100	SYS 36W	1740	80	2700	828 x 93 x 55	white/chrome	---	199,00



Spiegelleuchte, opale Polycarbonatabdeckung, Sockel aus Aluminium, Schirmbefestigung mittels Klappfedern, Einspeisung an der Seite bzw. mittig an der Leuchten-Rückseite möglich

Mirror light, opal polycarbonate cover, aluminium base, shade fastening by means of hinged springs, feed-in possible at the side or centre at the rear of the light

### MATAR

ART. NR./CODE	LEISTUNG/POWER	LUMEN	CRI>	KELVIN	L x B x H/L x W x H	FARBE ABDECKUNG/COLOUR COVER	FARBE SOCKEL/COLOUR SOCKET	PREIS/PRICE
789-71032	SYS 13W	1400	80	3000	600 x 60 x 46	white	white	174,70
789-71532	SYS 13W	1470	80	4000	600 x 60 x 46	white	white	174,70
789-71040	SYS 19W	2090	80	3000	900 x 60 x 46	white	white	228,70
789-71540	SYS 19W	2200	80	4000	900 x 60 x 46	white	white	228,70
789-71036	SYS 13W	1400	80	3000	600 x 60 x 46	white	black	174,70
789-71536	SYS 13W	1470	80	4000	600 x 60 x 46	white	black	167,30
789-71044	SYS 19W	2090	80	3000	900 x 60 x 46	white	black	228,70
789-71544	SYS 19W	2200	80	4000	900 x 60 x 46	white	black	228,70







NEW

**LANU FLAT W**

ART. NR./CODE	LM/BULB	FASSUNG/SOCKET	V AC	L x B x H/L x W x H	FARBE/COLOUR	PREIS/PRICE
222-00116	RETROFIT	G9	230	115 x 100 x 168	☐ white	139,00
222-00117	RETROFIT	G9	230	115 x 100 x 168	■ black	139,00
222-00118	RETROFIT	G9	230	115 x 100 x 168	■ chrome	149,00

IP44

**LEUCHTMITTEL/LIGHT SOURCE**

Weitere Leuchtmittel S./additional light sources P. 290

ART. NR./CODE	INFORMATION	PREIS/PRICE
30-657802	Core Pro LED Capsule, 69,5W, 827 Kelvin	26,40



Badezimmerleuchte mit IP44 Schutzklasse, Echtglas in zwei Ausführungen, G9 Leuchtmittel - flexibel in Lichtfarbe und Intensität

Bathroom light with IP44 protection class, real glass in two versions, G9 light source - flexible in light colour and intensity

NEW

**LANU ROUND W**

ART. NR./CODE	LM/BULB	FASSUNG/SOCKET	V AC	B x H/L x W x H	FARBE/COLOUR	PREIS/PRICE
222-00113	RETROFIT	G9	230	110 x 167	☐ white	139,00
222-00114	RETROFIT	G9	230	110 x 167	■ black	139,00
222-00115	RETROFIT	G9	230	110 x 167	■ chrome	149,00

IP44

**LEUCHTMITTEL/LIGHT SOURCE**

Weitere Leuchtmittel S./additional light sources P. 290

ART. NR./CODE	INFORMATION	PREIS/PRICE
30-657802	Core Pro LED Capsule, 69,5W, 827 Kelvin	26,40

**SCHUTZZONEN  
PROTECTION ZONES**

- ZONE 2 | IP44
- ZONE 3 | IP65
- ZONE 4 | IP67

**IP44**  
geschützt gegen Spritzwasser/  
Protected against splash water

**IP65**  
geschützt gegen Strahlwasser/  
Protected against water jets

**IP67**  
geschützt gegen zeitweises Eintauchen/  
Protected against temporary immersion

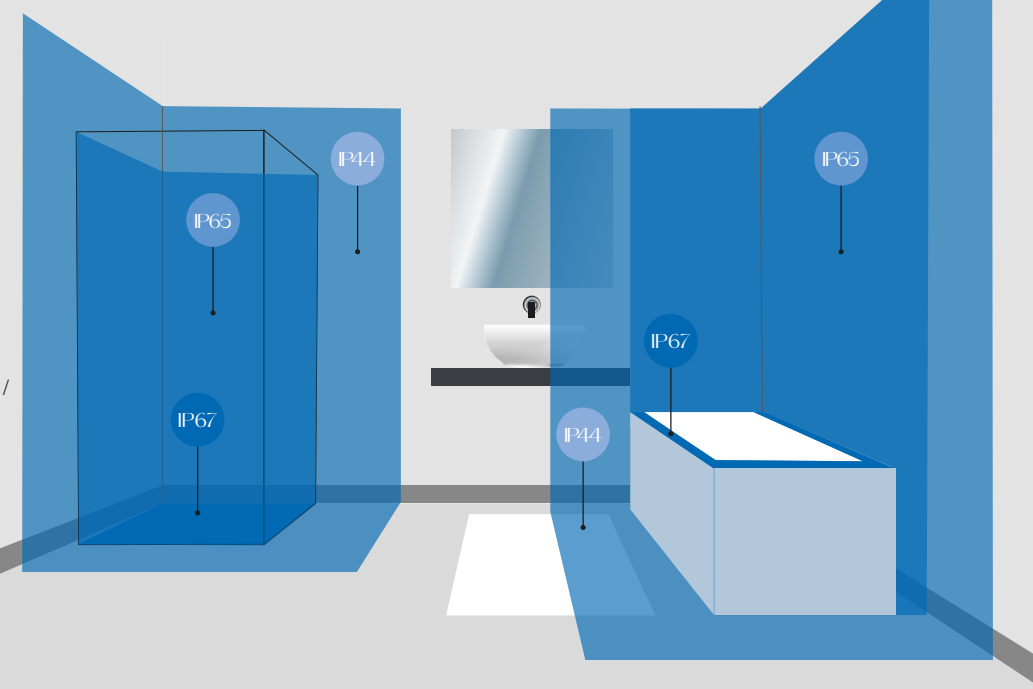



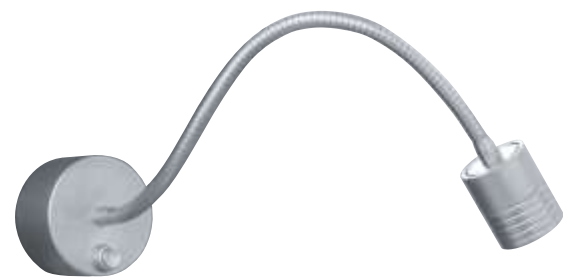

Wandleuchte aus Aluminium, perlchrom galvanisiert oder schwarz, runder Leuchtenkopf, hochwertige Glaslinse 60° klar, flexiblem Arm, Ein/Aus-Schalter an der Leuchte, inkl. Konverter, Kopf: Ø 34, L 40  
Baldachin: Ø 63, H 44

LED aluminium reading lamp, pearl chrome, chrome or black surface, high quality clear glass 60° lens, surface with switch, incl. driver  
Head: Ø 34, L 40  
Canopy: Ø 63, H 44

### MOTUS LONG W



ART. NR./CODE	LEISTUNG/POWER	LUMEN	CRI>	KELVIN	L	FARBE/COLOUR	REFL.	PREIS/PRICE
56-53312ng2	SYS 2W	160	90	3000	max. 380	perlchrome	60°	319,00
56-53313ng2	SYS 2W	160	90	3000	max. 380	black	60°	319,00



Flexible LED Leseleuchte Aluminium, Kopf & Wandmontage Flexarm schwarz, Lichtkegel stufenlos am Kopf fokussierbar 10° - 60°, Ein/Aus Schalter schwarz an der Leuchte, inkl. Konverter, Kopf: DM 20, L60, Baldachin: DM 63, H37

Flexible LED aluminium reading lamp, black arm, head with infinitely adjustable light cone 10° - 60°, incl. on/off switch, canopy: Ø 63, D 37mm, incl. driver



### ZHOOM W



ART. NR./CODE	LEISTUNG/POWER	LUMEN	CRI>	KELVIN	L	FARBE/COLOUR	PREIS/PRICE
56-185034ng1	SYS 2W	150	90	2700	max. 300	white	413,00
56-185036ng1	SYS 2W	150	90	2700	max. 300	black	413,00
56-185035ng1	SYS 2W	150	90	2700	max. 300	alu brushed	413,00
56-185033ng1	SYS 2W	150	90	3000	max. 300	white	413,00
56-185032ng1	SYS 2W	150	90	3000	max. 300	black	413,00
56-185030ng1	SYS 2W	150	90	3000	max. 300	alu brushed	413,00

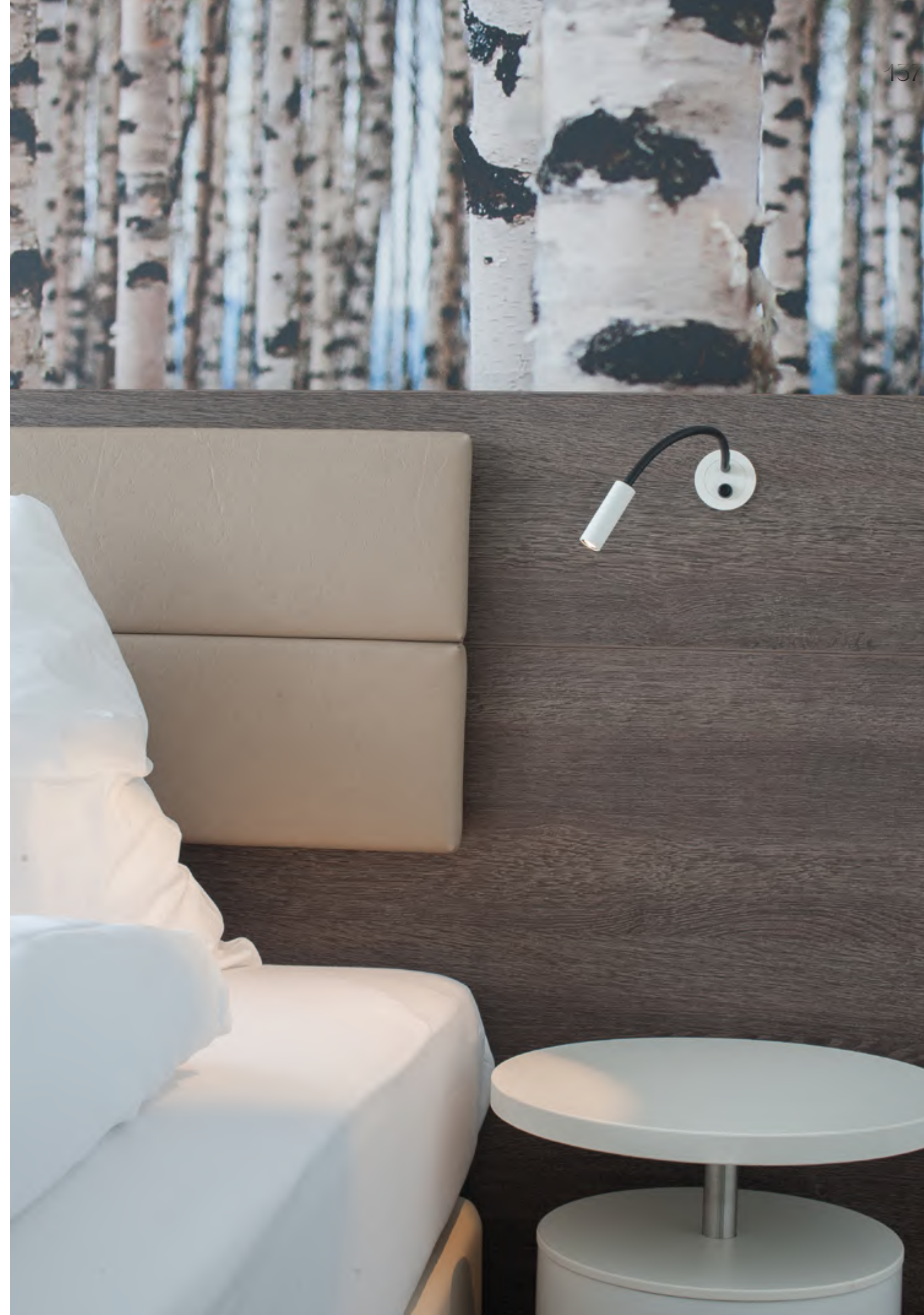



WALL

TECNICO INDOOR





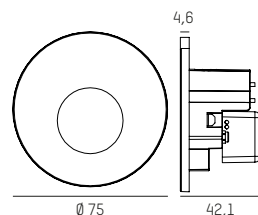

NEW

Wand-Einbauleuchte aus Aluminium, Helligkeit und Lichtfarbe vor Einbau einstellbar, Durchgangsverdrahtung

Recessed wall luminaire made of aluminium, brightness and light colour pre adjustable, through-wiring

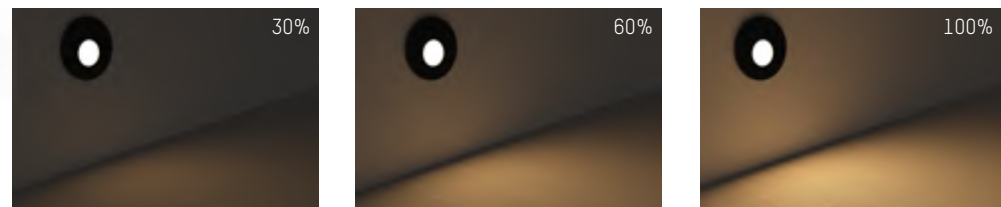

Einstellbare Helligkeit 30/60/100%/Adjustable brightness 30/60/100%

**WALL 68R**

ART. NR./CODE	LEISTUNG/POWER	LUMEN	CRI>	KELVIN	Ø x ET/Ø x ID	Ⓢ	FARBE/COLOUR	PREIS/PRICE
222-00001	SYS 4W	90	90	2700/3000/4000	75 x 42	68	white	89,00
222-00002	SYS 4W	90	90	2700/3000/4000	75 x 42	68	black	89,00

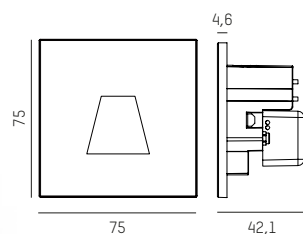

Wand-Einbauleuchte aus Aluminium, Helligkeit und Lichtfarbe vor Einbau einstellbar, Durchgangsverdrahtung

Recessed wall luminaire made of aluminium, brightness and light colour pre adjustable, through-wiring

**WALL 68R**

ART. NR./CODE	LEISTUNG/POWER	LUMEN	CRI>	KELVIN	L x B x ET/Ø x ID	Ⓢ	FARBE/COLOUR	PREIS/PRICE
222-00003	SYS 4W	60	90	2700/3000/4000	75 x 75 x 42	68	white	89,00
222-00004	SYS 4W	60	90	2700/3000/4000	75 x 75 x 42	68	black	89,00

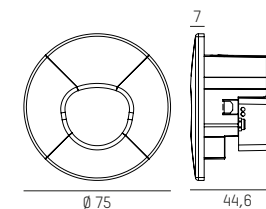

**WALL 68R SINA**

ART. NR./CODE	LEISTUNG/POWER	LUMEN	CRI>	KELVIN	Ø x ET/Ø x ID	Ⓢ	FARBE/COLOUR	PREIS/PRICE
222-00085	SYS 4W	140	90	2700/3000/4000	75 x 45	68	white	94,00
222-00086	SYS 4W	130	90	2700/3000/4000	75 x 45	68	black	94,00

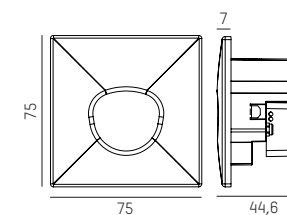

**WALL 68R SINA**

ART. NR./CODE	LEISTUNG/POWER	LUMEN	CRI>	KELVIN	L x B x ET/L x W x ID	Ⓢ	FARBE/COLOUR	PREIS/PRICE
222-00087	SYS 4W	140	90	2700/3000/4000	75 x 75 x 45	68	white	94,00
222-00088	SYS 4W	130	90	2700/3000/4000	75 x 75 x 45	68	black	94,00

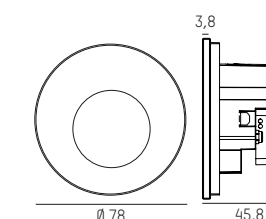

**WALL 68R GLASS**

ART. NR./CODE	LEISTUNG/POWER	LUMEN	CRI>	KELVIN	Ø x ET/Ø x ID	Ⓢ	FARBE/COLOUR	PREIS/PRICE
222-00077	SYS 4W	80	90	2700/3000/4000	78 x 46	68	white	99,00
222-00078	SYS 4W	40	90	2700/3000/4000	78 x 46	68	black	99,00

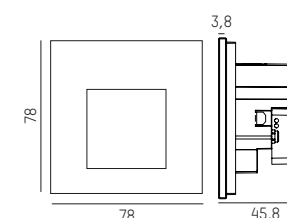

**WALL 68R GLASS**

ART. NR./CODE	LEISTUNG/POWER	LUMEN	CRI>	KELVIN	L x B x ET/Ø x ID	Ⓢ	FARBE/COLOUR	PREIS/PRICE
222-00079	SYS 4W	85	90	2700/3000/4000	78 x 78 x 46	68	white	99,00
222-00080	SYS 4W	50	90	2700/3000/4000	78 x 78 x 46	68	black	99,00





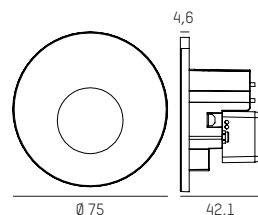

Wand-Einbauleuchte aus Aluminium, Helligkeit und Lichtfarbe vor Einbau einstellbar, Durchgangsverdrahtung, IP44

Recessed wall luminaire made of aluminium, brightness and light colour pre adjustable, through-wiring, IP44

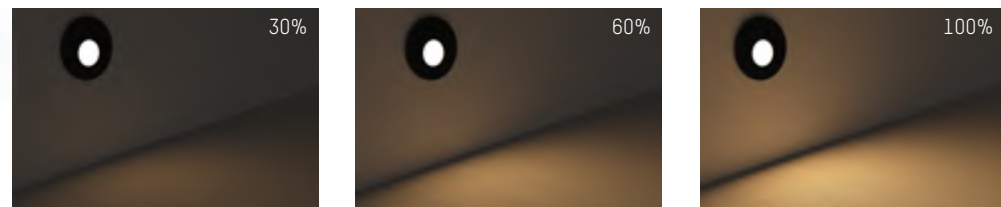

Einstellbare Helligkeit 30/60/100%/Adjustable brightness 30/60/100%

**WALL 68R IP44**

ART. NR./CODE	LEISTUNG/POWER	LUMEN	CRI>	KELVIN	Ø x ET/Ø x ID	Ⓢ	FARBE/COLOUR	PREIS/PRICE
222-00097	SYS 4W	150	90	2700/3000/4000	75 x 42	68	white	109,00
222-00098	SYS 4W	130	90	2700/3000/4000	75 x 42	68	black	109,00

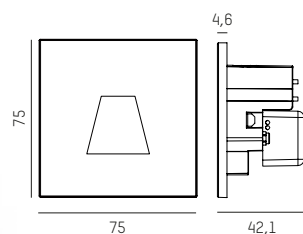

Wand-Einbauleuchte aus Aluminium, Helligkeit und Lichtfarbe vor Einbau einstellbar, Durchgangsverdrahtung, IP44

Recessed wall luminaire made of aluminium, brightness and light colour pre adjustable, through-wiring, IP44

**WALL 68R IP44**

ART. NR./CODE	LEISTUNG/POWER	LUMEN	CRI>	KELVIN	L x B x ET/Ø x ID	Ⓢ	FARBE/COLOUR	PREIS/PRICE
222-00099	SYS 4W	130	90	2700/3000/4000	75 x 75 x 42	68	white	109,00
222-00100	SYS 4W	105	90	2700/3000/4000	75 x 75 x 42	68	black	109,00

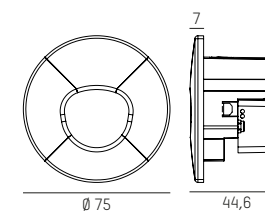

**WALL 68R SINA IP44**

ART. NR./CODE	LEISTUNG/POWER	LUMEN	CRI>	KELVIN	Ø x ET/Ø x ID	Ⓢ	FARBE/COLOUR	PREIS/PRICE
222-00105	SYS 4W	140	90	2700/3000/4000	75 x 45	68	white	114,00
222-00106	SYS 4W	130	90	2700/3000/4000	75 x 45	68	black	114,00

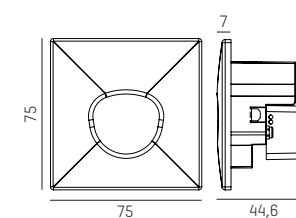

**WALL 68R SINA IP44**

ART. NR./CODE	LEISTUNG/POWER	LUMEN	CRI>	KELVIN	L x B x ET/L x W x ID	Ⓢ	FARBE/COLOUR	PREIS/PRICE
222-00107	SYS 4W	140	90	2700/3000/4000	75 x 75 x 45	68	white	114,00
222-00109	SYS 4W	130	90	2700/3000/4000	75 x 75 x 45	68	black	114,00

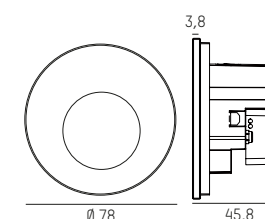

**WALL 68R GLASS IP44**

ART. NR./CODE	LEISTUNG/POWER	LUMEN	CRI>	KELVIN	Ø x ET/Ø x ID	Ⓢ	FARBE/COLOUR	PREIS/PRICE
222-00101	SYS 4W	80	90	2700/3000/4000	78 x 46	68	white	119,00
222-00102	SYS 4W	40	90	2700/3000/4000	78 x 46	68	black	119,00

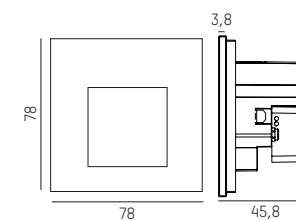

**WALL 68R GLASS IP44**

ART. NR./CODE	LEISTUNG/POWER	LUMEN	CRI>	KELVIN	L x B x ET/Ø x ID	Ⓢ	FARBE/COLOUR	PREIS/PRICE
222-00103	SYS 4W	85	90	2700/3000/4000	78 x 78 x 46	68	white	119,00
222-00104	SYS 4W	50	90	2700/3000/4000	78 x 78 x 46	68	black	119,00





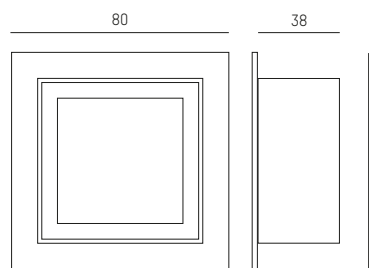

Wandeinbauleuchte, Aluminium eloxiert, quadratisch, symmetrisch, inkl. Haltefedern für Hohlwandmontage, exkl. Konverter, Betoneinbaugehäuse separat ordern

Recessed wall luminaire, aluminium anodised, asymmetrical, incl. holding spring for cavity wall mounting, excl. driver, recessed box to be ordered separately



### WINDOW I

ART. NR./CODE	LEISTUNG/POWER	mA	LUMEN	CRI>	KELVIN	B x H x ET/W x H x ID	U	FARBE/COLOUR	PREIS/PRICE
305-6801p	LED 3W	250	235	80	3000	80 x 80 x 38	69 x 69	alu brushed	39,00

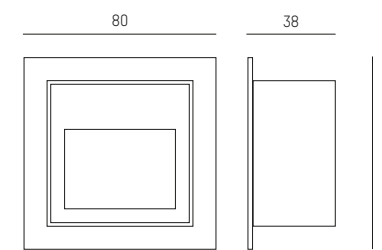

Wandeinbauleuchte, Aluminium eloxiert, quadratisch, asymmetrisch, inkl. Haltefedern für Hohlwandmontage, exkl. Konverter, Betoneinbaugehäuse separat ordern

Recessed wall luminaire, aluminium anodised, asymmetrical, incl. holding spring for cavity wall mounting, excl. driver, recessed box to be ordered separately



### WINDOW II

ART. NR./CODE	LEISTUNG/POWER	mA	LUMEN	CRI>	KELVIN	B x H x ET/W x H x ID	U	FARBE/COLOUR	PREIS/PRICE
305-6800p	LED 3W	250	165	80	3000	80 x 80 x 38	69 x 69	alu brushed	39,00

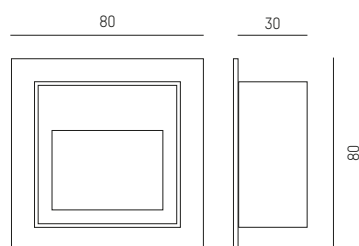

Wandeinbauleuchte aus Aluminium, quadratisch, pulverbeschichtet, asymmetrisch, Diffusor opal, Lichtaustritt direkt, inkl. Haltefedern für Hohlraummontage, exkl. Konverter, Betoneinbaugehäuse separat ordern

Recessed wall luminaire, die-cast aluminium, matt powder-coated with fine textured paint, asymmetrical light exit, opal diffuser, excl. converter, recessed box to be ordered separately



### PAN

ART. NR./CODE	LEISTUNG/POWER	mA	LUMEN	CRI>	KELVIN	B x H x ET/W x H x ID	U	FARBE/COLOUR	PREIS/PRICE
305-0130380003005	LED 3W	250	155	80	3000	80 x 80 x 62	69 x 69	white	45,00
305-0130380003004	LED 3W	250	155	80	3000	80 x 80 x 62	69 x 69	silver	45,00
305-0130380003006	LED 3W	250	155	80	3000	80 x 80 x 62	69 x 69	black	45,00



### BETONEINBAUGEHÄUSE/CONCRETE HOUSING



ART. NR./CODE	INFO	B x H x T/W x H x ID	ET L x B x H/ID x L x W x H	PREIS/PRICE
305-5058	Aus verzinktem Blech, inkl. Einputzrahmen, passend für WINDOW und PAN nicht für Sichtbeton geeignet/ made of galvanised sheet, incl. plastering frame, suitable for WINDOW I and PAN not suitable for exposed concrete	142 x 138 x 38	140 x 125 x 50	23,30

### KONVERTER/DRIVER



ART. NR./CODE	INFO	WATT	mA	V DC	V AC	L x B x H/L x W x H	FARBE/COLOUR	PREIS/PRICE
24-127719	on/off	6W	250	23	230	42 x 40 x 22	black	19,80





STROMSCHIENEN  
TRACKS

TECNICO INDOOR





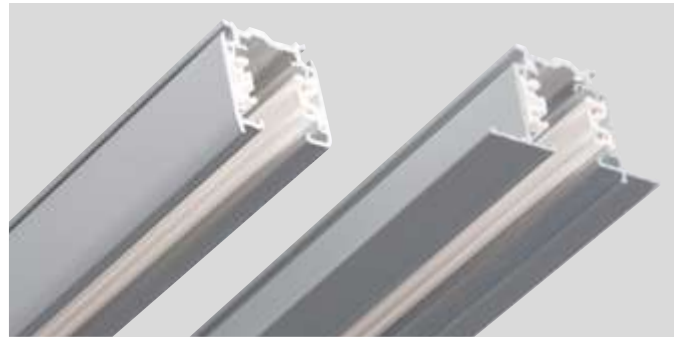

### 3-PHASEN SCHIENE 3-PHASE TRACK

3-Phasen Stromschiene aus Aluminiumprofil, Oberfläche pulverbeschichtet, Installation als Aufbau, Einbau- und Pendelmontage · Zubehör separat ordern

3-phase rail made of aluminium, surface powder-coated, surface, recessed or suspended mount, Order accessories separately

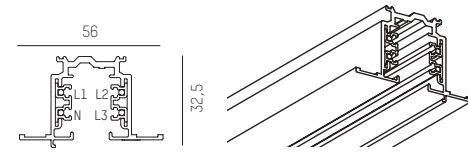
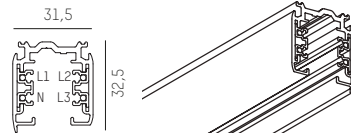

### 3-PHASEN SCHIENE AUFBAU/ABGEHÄNGT 3-PHASE TRACK SURFACE/PENDANT

ART. NR./CODE	LÄNGE/LENGHT	PREIS/PRICE
208-1910410X	1000 mm	33,70
208-1910420X	2000 mm	67,00
208-1910430X	3000 mm	100,60
208-1910440X	4000 mm	134,00



### 3-PHASEN SCHIENE EINBAU 3-PHASE TRACK RECESSED

ART. NR./CODE	LÄNGE/LENGHT	PREIS/PRICE
208-1910510X	1000 mm	39,80
208-1910520X	2000 mm	79,40
208-1910530X	3000 mm	119,00

### ENDKAPPE/END PIECE

Alle Stromschienen müssen mit einer Endkappe versehen werden!  
All track endings have to be equipped with endpieces!



ART. NR./CODE	PREIS/PRICE
208-1917041X	1,30

### BIEGEWERKZEUG/BENDING TOOL

Zum Biegen der Stromleiter bei gekürzter Schiene für easy conductor bending with shortened rails

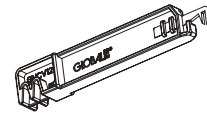

ART. NR./CODE	PREIS/PRICE
208-19135121	15,70

### ENDEINSPEISUNG/END POWER FEED



ART. NR./CODE	LÄNGE/LENGHT	PREIS/PRICE
208-1917011X	66 mm	11,00



### ENDEINSPEISUNG/END POWER FEED



ART. NR./CODE	LÄNGE/LENGHT	PREIS/PRICE
208-1917012X	66 mm	11,00



### MITTELSPEISUNG/CENTER POWER FEED



ART. NR./CODE	LÄNGE/LENGHT	PREIS/PRICE
208-1917014X	100 mm	25,00

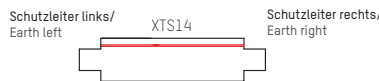

ERGÄNZEN SIE DIE ARTIKELNUMMER/COMPLETE CODE FOR TRACK

X = FARBE/COLOUR

<b>G</b> grey = 1	<b>S</b> black = 2	<b>W</b> white = 3
-------------------	--------------------	--------------------

### LINEARVERBINDER ELEKTRISCH/ LINEAR JUNCTION ELECTRIC

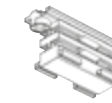

ART. NR./CODE	PREIS/PRICE
208-1917021X	8,90

### FLEXVERBINDER/FLEXIBLE JUNCTION

biegbar 0 - 360° / bendable 0 - 360° for easy conductor bending

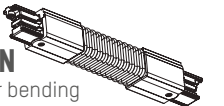

ART. NR./CODE	LÄNGE/LENGHT	PREIS/PRICE
208-1917023X	1782 mm	34,00

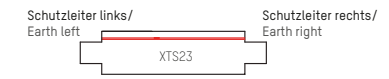

### WINKEL-VERBINDER/FLEXIBLE-JUNCTION

Mit Einspeisemöglichkeit / with optional power feed

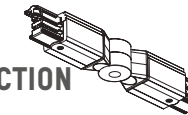

ART. NR./CODE	LÄNGE/LENGHT	PREIS/PRICE
208-1917024X	160 mm	34,00

### X-VERBINDER/X-JUNCTION

Mit Einspeisemöglichkeit / with optional power feed

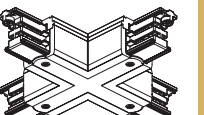

ART. NR./CODE	L x B/L x W	PREIS/PRICE
208-1917038X	100 x 100 mm	54,00

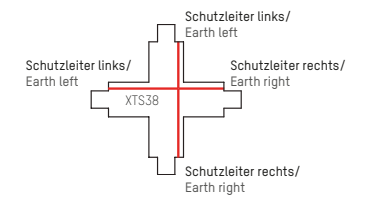

### L-VERBINDER/L-JUNCTION

Mit Einspeisemöglichkeit / with optional power feed

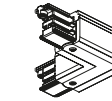

ART. NR./CODE	L x B/L x W	PREIS/PRICE
208-1917034X	66 x 66 mm	28,00

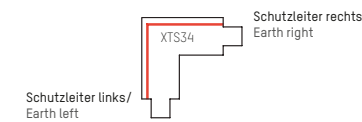

### L-VERBINDER/L-JUNCTION

Mit Einspeisemöglichkeit / with optional power feed

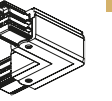

ART. NR./CODE	L x B/L x W	PREIS/PRICE
208-1917035X	66 x 66 mm	28,00

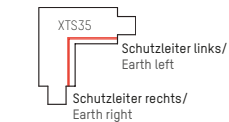

### T-VERBINDER/T-JUNCTION

Mit Einspeisemöglichkeit / with optional power feed

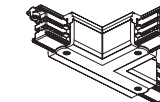

ART. NR./CODE	L x B/L x W	PREIS/PRICE
208-1917036X	100 x 66 mm	42,00

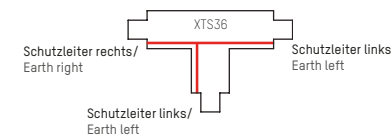

### T-VERBINDER/T-JUNCTION

Mit Einspeisemöglichkeit / with optional power feed

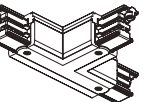

ART. NR./CODE	L x B/L x W	PREIS/PRICE
208-1917037X	100 x 66 mm	42,00

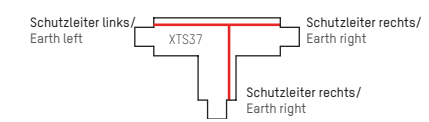

### T-VERBINDER/T-JUNCTION

Mit Einspeisemöglichkeit / with optional power feed

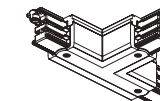

ART. NR./CODE	L x B/L x W	PREIS/PRICE
208-1917039X	100 x 66 mm	42,00

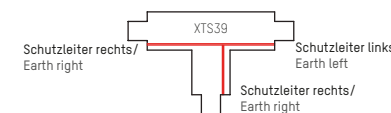

### T-VERBINDER/T-JUNCTION

Mit Einspeisemöglichkeit / with optional power feed

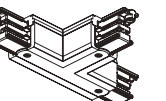

ART. NR./CODE	L x B/L x W	PREIS/PRICE
208-1917040X	100 x 66 mm	42,00

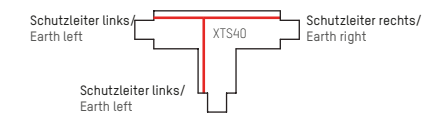

ERGÄNZEN SIE DIE ARTIKELNUMMER/COMPLETE CODE FOR TRACK

X = FARBE/COLOUR

<b>G</b> grey = 1	<b>S</b> black = 2	<b>W</b> white = 3
-------------------	--------------------	--------------------



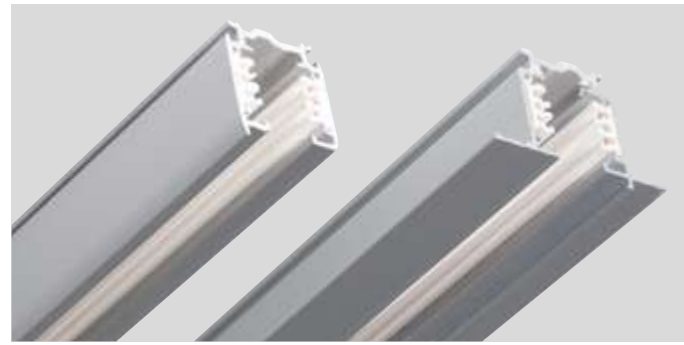

### 3-PHASEN SCHIENE PULSE DALI/ 3-PHASE TRACK PULSE DALI

3-Phasen Stromschiene aus Aluminiumprofil, Oberfläche pulverbeschichtet, Installation als Aufbau, Einbau- und Pendelmontage, Zubehör separat ordern

3-phase rail made of aluminium, surface powder-coated, surface, recessed or suspended mount · Order accessories separately

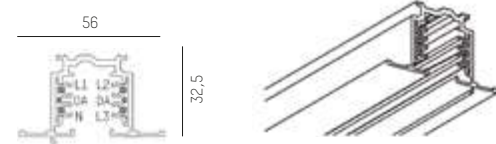

### 3-PHASEN SCHIENE AUFBAU-ABGEHÄNGT DALI/ 3-PHASE TRACK SURFACE-PENDANT DALI

### 3-PHASEN SCHIENE EINBAU DALI/ 3-PHASE TRACK RECESSED DALI

ART. NR./CODE	LÄNGE/LENGHT	PREIS/PRICE
208-1910610X	1000 mm	39,00
208-1910620X	2000 mm	77,70
208-1910630X	3000 mm	116,70
208-1910640X	4000 mm	155,50

ART. NR./CODE	LÄNGE/LENGHT	PREIS/PRICE
208-1910650X	1000 mm	45,50
208-1910660X	2000 mm	90,90
208-1910670X	3000 mm	136,00
208-1910680X	4000 mm	162,00



### ENDKAPPE/END PIECE

Alle Stromschienen müssen mit einer Endkappe versehen werden!  
All track endings have to be equipped with endpieces!



### BIEGEWERKZEUG/BENDING TOOL

Zum Biegen der Stromleiter bei gekürzter Schiene/  
for easy conductor bending with shortened rails

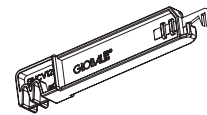

ART. NR./CODE	PREIS/PRICE
208-1917041X	1,30

ART. NR./CODE	PREIS/PRICE
208-19135121	15,70

### ENDEINSPEISUNG/END POWER FEED

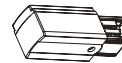

### ENDEINSPEISUNG/END POWER FEED



ART. NR./CODE	LÄNGE/LENGHT	PREIS/PRICE
208-191c611X	90 mm	21,80

ART. NR./CODE	LÄNGE/LENGHT	PREIS/PRICE
208-191c612X	90 mm	21,80



### MITTELSPEISUNG/CENTER POWER FEED



ART. NR./CODE	LÄNGE/LENGHT	PREIS/PRICE
208-191nc614X	150 mm	48,00



ERGÄNZEN SIE DIE ARTIKELNUMMER/COMPLETE CODE FOR TRACK

X = FARBE/COLOUR

**6** grey = 1

**s** black = 2

**w** white = 3

### LINEARVERBINDER ELEKTRISCH/ LINEAR JUNCTION ELECTRIC

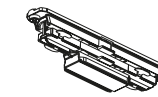

ART. NR./CODE	PREIS/PRICE
208-191d621X	13,80

### X-VERBINDER/X-JUNCTION

Mit Einspeisemöglichkeit/with optional power feed

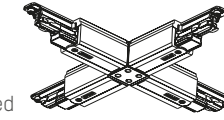

ART. NR./CODE	L x B/L x W	PREIS/PRICE
208-191nc638X	150 x 150 mm	97,00

### L-VERBINDER/L-JUNCTION

Mit Einspeisemöglichkeit/with optional power feed

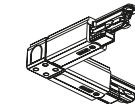

ART. NR./CODE	L x B/L x W	PREIS/PRICE
208-191nc634X	91 x 91 mm	48,00

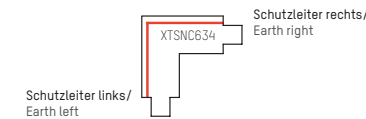

### T-VERBINDER/T-JUNCTION

Mit Einspeisemöglichkeit/with optional power feed

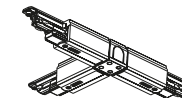

ART. NR./CODE	L x B/L x W	PREIS/PRICE
208-191nc636X	150 x 91 mm	73,00

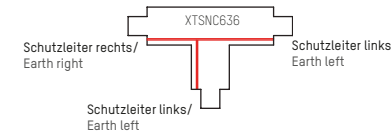

### T-VERBINDER/T-JUNCTION

Mit Einspeisemöglichkeit/with optional power feed

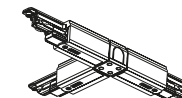

ART. NR./CODE	L x B/L x W	PREIS/PRICE
208-191nc639X	150 x 91 mm	73,00

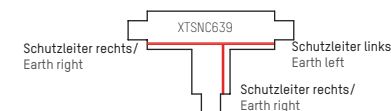

### FLEXVERBINDER/FLEXIBLE JUNCTION

biegbar 0 - 360°/bendable 0 - 360° for easy conductor bending

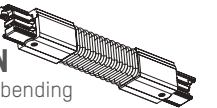

ART. NR./CODE	LÄNGE/LENGHT	PREIS/PRICE
208-191c623X	223 mm	72,60



### L-VERBINDER/L-JUNCTION

Mit Einspeisemöglichkeit/with optional power feed

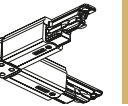

ART. NR./CODE	L x B/L x W	PREIS/PRICE
208-191nc635X	91 x 91 mm	48,00

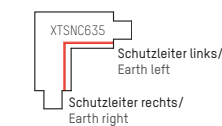

### T-VERBINDER/T-JUNCTION

Mit Einspeisemöglichkeit/with optional power feed

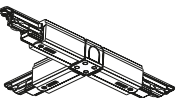

ART. NR./CODE	L x B/L x W	PREIS/PRICE
208-191nc637X	150 x 91 mm	73,00

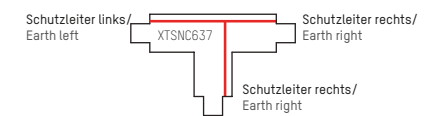

### T-VERBINDER/T-JUNCTION

Mit Einspeisemöglichkeit/with optional power feed

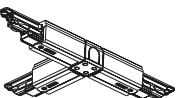

ART. NR./CODE	L x B/L x W	PREIS/PRICE
208-191nc640X	150 x 91 mm	73,00

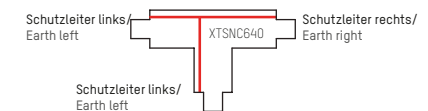



## ABHÄNGESET/ SUSPENSION SET

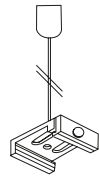

ART. NR./CODE	LÄNGE/LENGHT	FARBE/COLOUR	PREIS/PRICE
208-19003	1500 mm	white	10,00
208-19002	1500 mm	black	10,00
208-19001	1500 mm	grey	10,00

## MONTAGEBÜGEL/ INSTALLATION BRACKET

für 3-Phasen Einbauschiene, inkl. Schraube M 4x 60/  
for 3-phase recessed track, incl screw M 4x 60

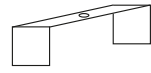

ART. NR./CODE	FARBE/COLOUR	PREIS/PRICE
775-hv60000808	grey	6,40

## DECKENBEFESTIGUNG/ SURFACE FIXATION



ART. NR./CODE	FARBE/COLOUR	PREIS/PRICE
208-19180116	white	6,40
208-19180115	black	6,40
208-19180114	alu brushed	6,40

## SCHNELLBEFESTIGUNG/ FAST FIXATION SET

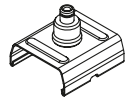

ART. NR./CODE	FARBE/COLOUR	PREIS/PRICE
639-as	nickel	6,90

## DECKENBEFESTIGUNGSSET/ CEILING FIXATION

2 Halterungen + 2 Kabelfixierungen/  
2 holders + 2 cable fix



ART. NR./CODE	FARBE/COLOUR	PREIS/PRICE
5-plsb	nickel	9,60

## MULTIADAPTER SCHIENE/ MULTIADAPTER TRACK

Tragkraft: 10 kg/payload: 10 kg

ART. NR./CODE	L x B x H/L x W x H	FARBE/COLOUR	PREIS/PRICE
208-19130681	85 x 30 x 55	white	12,70
208-19130685	85 x 30 x 55	black	12,70
208-19130684	85 x 30 x 55	grey	12,70

## MULTIADAPTER PULS DALI SCHIENE/ MULTIADAPTER PULSE DALI TRACK

Tragkraft: 10 kg/payload: 10 kg

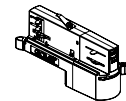

ART. NR./CODE	L x B x H/L x W x H	FARBE/COLOUR	PREIS/PRICE
208-19137403	105 x 30 x 55	white	22,50
208-19137402	105 x 30 x 55	black	22,50
208-19137401	105 x 30 x 55	grey	22,50

## ABHÄNGESET/ SUSPENSION SET

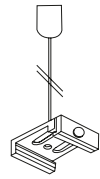

ART. NR./CODE	LÄNGE/LENGHT	FARBE/COLOUR	PREIS/PRICE
208-19005	3000 mm	white	11,60
208-19006	3000 mm	black	11,60
208-19004	3000 mm	grey	11,60

## DECKENHALTERUNG/ SURFACE FIXATION

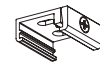

ART. NR./CODE	FARBE/COLOUR	PREIS/PRICE
208-19180123	white	2,80
208-19180122	black	2,80
208-19180121	alu brushed	2,80

## STAHLSEIL/ STEEL CABLE

beliebig kürzbar, Ø 1,5 mm/  
cut to any length, Ø 1,5 mm

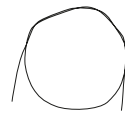

ART. NR./CODE	LÄNGE/LENGTH	PREIS/PRICE
208-19190501	per Meter/ per metre	1,10

## KABELABHÄNGUNGSSET/ CABLE SUSPENSION SET

beliebig kürzbar, Ø 1,2 mm/  
cut to any length, Ø 1,2 mm

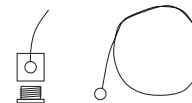

ART. NR./CODE	LÄNGE/LENGTH	PREIS/PRICE
639-s1600	1600	6,70
639-s3000	3000	7,20
639-s6000	6000	9,50

## SEIL SCHNELLBEFESTIGUNG HOCH/ CABLE FAST FIXATION SET HIGH

Bietet Platz für ein 20mm Installationsrohr zw. Stromschiene und Befestigungsset; Stahlseil und Deckenbefestigungsset separat ordern/  
Allows space for a 20mm installation pipe between the busbar and the fixing set; order steel cable & ceiling fixation separately



ART. NR./CODE	FARBE/COLOUR	PREIS/PRICE
639-ash	nickel	13,90

## MULTIADAPTER SCHIENE/ MULTIADAPTER TRACK

Tragkraft: 5 kg/payload: 5 kg

ART. NR./CODE	L x B x H/L x W x H	FARBE/COLOUR	PREIS/PRICE
208-19130698	70 x 30 x 40	white	11,90
208-19130697	70 x 30 x 40	black	11,90
208-19130696	70 x 30 x 40	grey	11,90

## MULTIADAPTER PULS DALI SCHIENE/ MULTIADAPTER PULSE DALI TRACK

Tragkraft: 5 kg/payload: 5 kg

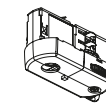

ART. NR./CODE	L x B x H/L x W x H	FARBE/COLOUR	PREIS/PRICE
208-19137503	105 x 30 x 40	white	19,30
208-19137502	105 x 30 x 40	black	19,30
208-19137501	105 x 30 x 40	grey	19,30

## BLINDADAPTER SCHIENE/ BLINDADAPTER TRACK

Tragkraft: 10 kg zur Aufhängung von Leuchten/  
payload: 10 kg for mounting luminaires



ART. NR./CODE	FARBE/COLOUR	PREIS/PRICE
208-19162173	white	6,60
208-19162172	black	6,60
208-19162171	grey	6,60

## ALUNIPPEL/ BARREL NIPPLE

L: 12 mm, zum Fixation von Strahlern am Adapter/  
L: 12 mm, for fixation spotlight to adapter

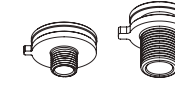

ART. NR./CODE	GRÖSSE/SIZE	FARBE/COLOUR	PREIS/PRICE
208-19130551	M 13 x 1	alu polished	2,50
208-19130571	M 10 x 1	alu polished	2,50

## ZUGENTLASTUNG/ CORD GRIP

Zum Aufschrauben auf Alu-Nippel M10/  
for fixation on barrel nipple M10



ART. NR./CODE	FARBE/COLOUR	PREIS/PRICE
208-19825016	white	1,50
208-19825019	black	1,50

## ABDECKUNG FÜR 3-PHASENSCHIENE/ COVERPLATE FOR 3-PHASE TRACK

für T, L und X Verbinder nur für Einbauschiene/  
for T, L and X junction for recessed track only

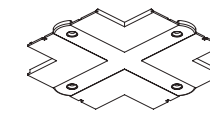

ART. NR./CODE	FARBE/COLOUR	PREIS/PRICE
208-19172303	white	3,00
208-19172302	black	3,00
208-19172302	grey	3,00

## ABDECKUNG FÜR 3-PHASENSCHIENE/ COVER FOR 3-PHASE TRACK

für Mittel- und Endeinspeisung nur für Einbauschiene/  
for center and end power feed for recessed track only

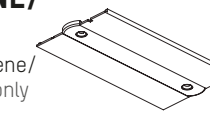

ART. NR./CODE	FARBE/COLOUR	PREIS/PRICE
208-19172103	white	2,80
208-19172102	black	2,80
208-19172101	grey	2,80

## ADAPTER FÜR DEKOHAKEN/ ADAPTER FOR DECO HOOK

zum einklipsen in die Schiene/  
to clip into rail

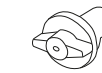

ART. NR./CODE	FARBE/COLOUR	PREIS/PRICE
208-19160143	white	1,10
208-19160142	black	1,10
208-19160141	grey	1,10

## SCHUKO ADAPTER/ BLINDADAPTER

16A

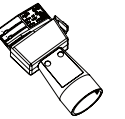

ART. NR./CODE	FARBE/COLOUR	PREIS/PRICE
208-19130678	white	56,60
208-19130677	black	56,60

## ZUGENTLASTUNG/ CORD GRIP

Zum Aufschrauben auf Alu-Nippel M13/  
for fixation on barrel nipple M13



ART. NR./CODE	FARBE/COLOUR	PREIS/PRICE
208-19130133	white	2,00
208-19130132	black	2,00

## ABDECKUNG FÜR 3-PHASENSCHIENE PULSE DALI/ COVERPLATE FOR 3-PHASE PULSE DALI TRACK

für T, L und X Verbinder nur für Einbauschiene/  
for T, L and X junction for recessed track only



ART. NR./CODE	FARBE/COLOUR	PREIS/PRICE
208-191f6303	white	3,20
208-191f6302	black	3,20
208-191f6301	grey	3,20

## ABDECKUNG FÜR 3-PHASENSCHIENE PULSE DALI/ COVER FOR 3-PHASE PULSE DALI TRACK

für Mittel- und Endeinspeisung nur für Einbauschiene/  
for center and end power feed for recessed track only

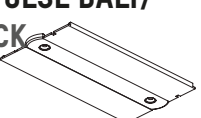

ART. NR./CODE	FARBE/COLOUR	PREIS/PRICE
208-191f6103	white	3,00
208-191f6102	black	3,00
208-191f6101	grey	3,00

## DEKOHAKEN/ DECO HOOK

Adapter separat ordern/  
order adapter separately



ART. NR./CODE	FARBE/COLOUR	PREIS/PRICE
208-19160111	steel	0,40





NEW

**MOOVE TRACK**

ART. NR./CODE	LM/BULB	FASSUNG/SOCKET	V AC	Ø x L x B/Ø x L x W	FARBE/COLOUR	PREIS/PRICE
222-00162	RETROFIT	QPAR 16/GU10	230	87 x 170 x 67	□ white	69,00
222-00163	RETROFIT	QPAR 16/GU10	230	87 x 170 x 67	■ black	69,00



**LEUCHTMITTEL/LIGHT SOURCE**

Weitere Leuchtmittel S./additional light sources P. 290

ART. NR./CODE	INFORMATION	PREIS/PRICE
30-752517	Core Pro LED Spot, GU10,5W, 827 Kelvin, nicht dimmbar/not dimmable	6,50

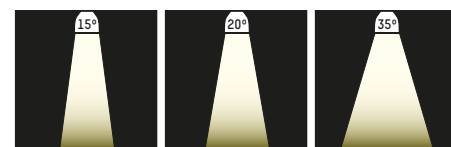

LED Stromschienenstrahler, Aluminiumdruckguss, Oberfläche pulverbeschichtet, LED Konverter in 3-Phasen Adapter integriert

Die cast aluminium LED track spotlight, surface microstructure painting, LED Driver integrated in 3 phase adapter

**SHOPSTAR LEAN TRACK**

ART. NR./CODE	LEISTUNG/POWER	LUMEN	Ø x H x T/Ø x H x ID	PREIS/PRICE
608-00301CRWWXXYv1	SYS 27W	2400-2810	95 x 150 134	ab 184,00
608-00302CRWWXXYv1	SYS 34W	2800-3280	95 x 150 134	ab 184,00



COMPLETE CODE				
C = COVER	R = BEAM ANGLE	WW = LIGHT COLOUR	XX = COLOUR	Y = DIMMABLE
with glass = 0 without glass = 1	□ spot 15° = 2 □ medium 20° = 5 □ flood 35° = 8 □ wide flood 60° = 9	W2 LED 2700K = 43 PREMIUM CRI>90 W3 LED 3000K = 49 PREMIUM CRI>90 W4 LED 4000K = 24 CRI>90	G grey = 04 W white = 05 S black = 06	S switchable = 0 P PULSE DALI dimm = p



TECNICO INDOOR

IGLE Bookstore, Amsterdam, Netherlands, Project by Unique Brands, Designer: M+R Interior Architecture, Foto: Studio de Winter





Schienenstrahler, aus Aluminium, 3-Phasen-Adapter für 3-Phasen-Schienensystem, Ausstrahlwinkel 40°, Lichtaustritt direkt, Phasenabschnitt dimmbar

Track spotlight, made of aluminium, 3-phase adapter for 3-phase track system, beam angle 40°, direct light emission, phase cut dimming

NEW

**MAG TRACK**



ART. NR./CODE	LEISTUNG/POWER	LUMEN	CRI>	KELVIN	Ø x H/Ø x H	FARBE/COLOUR	REFL.	PREIS/PRICE
222-00148	SYS 16W	940	90	2700	120 x 103	white	40°	199,00
222-00149	SYS 16W	940	90	2700	120 x 103	black	40°	199,00
222-00150	SYS 16W	1040	90	3000	120 x 103	white	40°	199,00
222-00151	SYS 16W	1040	90	3000	120 x 103	black	40°	199,00



Schienenstrahler, aus Aluminium, 3-Phasen-Adapter für 3-Phasen-Schienensystem, Ausstrahlwinkel 40°, Lichtaustritt direkt, Phasenabschnitt dimmbar

Track spotlight, made of aluminium, 3-phase adapter for 3-phase track system, beam angle 40°, direct light emission, phase cut dimming

NEW

**MAGIS TRACK**



ART. NR./CODE	LEISTUNG/POWER	LUMEN	CRI>	KELVIN	Ø x H/Ø x H	FARBE/COLOUR	REFL.	PREIS/PRICE
222-00152	SYS 16W	1160	90	2700	100 x 130	white	36°	169,00
222-00153	SYS 16W	1160	90	2700	100 x 130	black	36°	169,00
222-00154	SYS 16W	1280	90	3000	100 x 130	white	36°	169,00
222-00155	SYS 16W	1280	90	3000	100 x 130	black	36°	169,00



**MAGIS DEKORRING/DECORATION RING**

ART. NR./CODE	FARBE/COLOUR	PREIS/PRICE
276-7004	gold	12,20
276-7005	white	12,20
276-7006	black	12,20



**MAGIS TAUSCHREFLEKTOR/REPLACEMENT REFLECTOR**

ART. NR./CODE	REF	PREIS/PRICE
276-7010	20°	15,90
276-7011	30°	15,90





## TRACK SET MOOVE



ART. NR./CODE	SET INHALT/SET CONTENT	FARBE/COLOUR	PREIS/PRICE
55-00001	1m 3-Phasenschiene, 3x MOOVE TRACK Strahler, LM RETROFIT, FASSUNG QPAR 16/GU10, V AC 230 1m 3-phase track, 3x MOOVE TRACK Spots, bulb RETROFIT, Socket QPAR 16/GU10, V AC 230	□ white	253,00
55-00002	1m 3-Phasenschiene, 3x MOOVE TRACK Strahler, LM RETROFIT, FASSUNG QPAR 16/GU10, V AC 230 1m 3-phase track, 3x MOOVE TRACK Spots, bulb RETROFIT, Socket QPAR 16/GU10, V AC 230	■ black	253,00



3-Phasenschienenset bestehend aus: 2 oder 3 Strahler, 1m 3-Phasenschiene, Einspeisung und Endkappe

3-phase track set consisting of: 2 or 3 spotlights, 1m 3-phase track, power feed and end cap



## TRACK SET MAG



ART. NR./CODE	SET INHALT/SET CONTENT	KELVIN	FARBE/COLOUR	PREIS/PRICE
55-00003	1m 3-Phasenschiene, 2x MAG TRACK Strahler, SYS 16W, 1290lm, CRI>90, Ref. 40° 1m 3-phase track, 2x MAG TRACK Spots, SYS 16W, 1290lm, CRI>90, Ref. 40°	2700	□ white	444,00
55-00004	1m 3-Phasenschiene, 2x MAG TRACK Strahler, SYS 16W, 1290lm, CRI>90, Ref. 40° 1m 3-phase track, 2x MAG TRACK Spots, SYS 2x 13W, 1290lm, CRI>90, Ref. 40°	2700	■ black	444,00
55-00005	1m 3-Phasenschiene, 2x MAG TRACK Strahler, SYS 16W, 1605lm, CRI>90, Ref. 40° 1m 3-phase track, 2x MAG TRACK Spots, SYS 16W, 2x 1605lm, CRI>90, Ref. 40°	3000	□ white	444,00
55-00006	1m 3-Phasenschiene, 2x MAG TRACK Strahler, SYS 16W, 1605lm, CRI>90, Ref. 40° 1m 3-phase track, 2x MAG TRACK Spots, SYS 16W, 1605lm, CRI>90, Ref. 40°	3000	■ black	444,00



LED-PANELE  
LED PANELS







LED-Panel-Einlegeleuchte, Aluminiumrahmen weiß lackiert, mit nanoprisatischer Abdeckung aus hochwertigem PMMA (kein Vergilben), Lichtfarbe einstellbar (3000 oder 4000K), Zubehör separat ordern

LED panel recessed light, white lacquered aluminium frame, with nanoprismatic cover made of high-quality PMMA (no yellowing), adjustable light colour (3000 or 4000K), order accessories separately



**RETRO 595R**

ART. NR./CODE	LEISTUNG/POWER	LUMEN	CRI>	KELVIN	L x B x H/L x W x H	ET/ID	FARBE/COLOUR	REFL.	PREIS/PRICE
222-00159	SYS 38W	4790/4910	80	3000/4000	595 x 595 x 28	60	white	90°	79,00



**620R**

ART. NR./CODE	LEISTUNG/POWER	LUMEN	CRI>	KELVIN	L x B x H/L x W x H	ET/ID	FARBE/COLOUR	REFL.	PREIS/PRICE
222-00160	SYS 38W	4790/4910	80	3000/4000	620 x 620 x 28	60	white	90°	79,00



**RETRO 1230R**

ART. NR./CODE	LEISTUNG/POWER	LUMEN	CRI>	KELVIN	L x B x H/L x W x H	ET/ID	FARBE/COLOUR	REFL.	PREIS/PRICE
222-00161	SYS 38W	4790/4910	80	3000/4000	1195 x 295 x 28	60	white	90°	79,00



**AUFBAURAHMEN/  
SURFACE MOUNTING FRAME**  
RETRO 595R



ART. NR./CODE	L x B x H/L x B x H	PREIS/PRICE
222-A00159	600 x 600 x 70	39,00

**AUFBAURAHMEN/  
SURFACE MOUNTING FRAME**  
RETRO 620R



ART. NR./CODE	L x B x H/L x B x H	PREIS/PRICE
222-A00160	625 x 625 x 70	39,00

**AUFBAURAHMEN/  
SURFACE MOUNTING FRAME**  
RETRO 1230R



ART. NR./CODE	L x B x H/L x B x H	PREIS/PRICE
222-A00161	1200 x 300 x 70	44,00

**EINBAUKLAMMERN/  
RECESSED BRACKETS**  
Set 6 Stk./Set 6 pcs.



ART. NR./CODE	PREIS/PRICE
222-A00162	9,00

**KONVERTER BOX/  
DRIVER BOX**  
RETRO 595R



ART. NR./CODE	L x B x H/L x B x H	PREIS/PRICE
222-A00163	250 x 75 x 45	24,00

**ABHÄNGESET/  
SUSPENSION SET**  
6 Stk./Set 6 pcs.



ART. NR./CODE	L	PREIS/PRICE
222-A00164	3000	15,00

**EINBAURAHMEN 600/  
RECESS MOUNTING FRAME**  
RETRO 595R



ART. NR./CODE	L x B x H/L x B x H	PREIS/PRICE
222-A00165	600 x 600 x 25	39,00

**EINBAURAHMEN 625/  
RECESS MOUNTING FRAME**  
RETRO 620R



ART. NR./CODE	L x B x H/L x B x H	PREIS/PRICE
222-A00166	625 x 625 x 25	39,00

**EINBAURAHMEN 1230/  
RECESS MOUNTING FRAME**  
RETRO 1230R

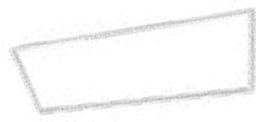

ART. NR./CODE	L x B x H/L x B x H	PREIS/PRICE
222-A00167	1200 x 30 x 25	44,00

**KONVERTER/DRIVER**

ART. NR./CODE	INFO	WATT	mA	V DC	V AC	L x B x H/L x W x H	FARBE/COLOUR	PREIS/PRICE
30-880206	on/off	39W	900	44	230	156 x 43 x 30	white	15,00
24-127490	DALI	16W-38W	300-1050	54-34	230	147 x 44 x 30	white	67,80





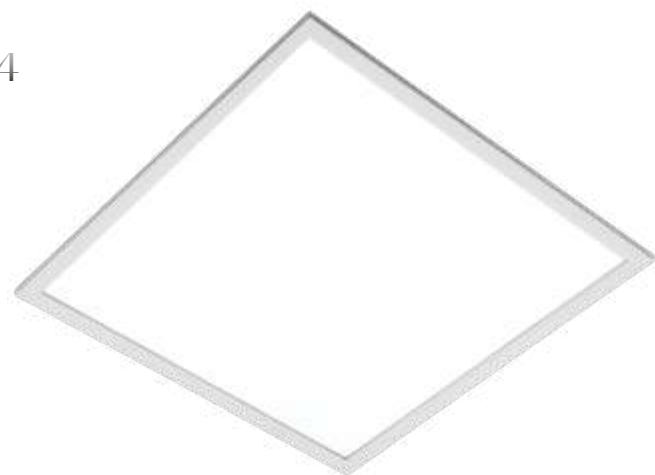

LED-Paneleinlegeleuchte, Aluminiumrahmen weiß lackiert, Modul 625, mit transluzenter PMMA Opal- oder nanoprismatischer Abdeckung, Zubehör separat ordern, zu betreiben mit 900mA oder 1200mA (Konverter separat ordern)

LED recessed panel luminaire, white aluminium frame painted aluminium frame, module 625, with translucent PMMA opal or nanoprismatic cover, order accessories order separately, to be operated with 900mA or 1200mA (order converter separately)

**FIT**

ART. NR./CODE	DIFFUSER/DIFFUSOR	LUMEN BEI 900mA LUMEN WITH 900mA	LUMEN BEI 1200mA LUMEN WITH 1200mA	CRI>	KELVIN	L x B x H/ L x W x H	ET/ID	FARBE/ COLOUR	PREIS/ PRICE
		<b>LED 35W</b>	<b>LED 57W</b>						
757-625pm30fitwok	OPAL	4400	5500	80	3000	622 x 622 x 15	55	white	163,10
757-625pm40fitwok	OPAL	4500	5700	80	4000	622 x 622 x 15	55	white	163,10
757-625np30fitwok	MIKROPRISMA (UGR <19)	4100	5800	80	3000	622 x 622 x 15	55	white	159,90
757-625np40fitwok	MIKROPRISMA (UGR <19)	4500	5700	80	4000	622 x 622 x 15	55	white	159,90

**KONVERTER SEPARAT ORDERN/ORDER DRIVER SEPARATELY**

IP40	UGR<19	757-k900s	757-k1200s	nicht dimmbar/not dimmable	31,80	42,40
		757-k900d	757-k1200d	DALI dimmbar/DALI dimmable	87,90	97,40

**FIT LONG**

ART. NR./CODE	DIFFUSER/DIFFUSOR	LUMEN/W BEI 900mA LUMEN/W WITH 900mA	LUMEN/W BEI 1200mA LUMEN/W WITH 1200mA	CRI>	KELVIN	L x B x H/ L x W x H	ET/ID	FARBE/ COLOUR	PREIS/ PRICE
		<b>LED 35W</b>	<b>LED 57W</b>						
757-1250pm30fitwok	OPAL	4100	5500	80	3000	1246 x 310 x 15	55	white	187,40
757-1250pm40fitwok	OPAL	4100	5500	80	4000	1246 x 310 x 15	55	white	187,40
757-1250np30fitwok	MIKROPRISMA (UGR <19)	4200	5700	80	3000	1246 x 310 x 15	55	white	183,20
757-1250np40fitwok	MIKROPRISMA (UGR <19)	4200	5700	80	4000	1246 x 310 x 15	55	white	183,20

**KONVERTER SEPARAT ORDERN/ORDER DRIVER SEPARATELY**

IP40	UGR<19	757-k900s	757-k1200s	nicht dimmbar/not dimmable	31,80	42,40
		757-k900d	757-k1200d	DALI dimmbar/DALI dimmable	87,90	97,40



**AUFBAURAHMEN FIT/SURFACE MOUNTING FRAME FIT**

ART. NR./CODE	INFO	L x B x H/L x W x H	FARBE/COLOUR	PREIS/PRICE
757-625abr	Aufbaurahmen für LED Pannelleuchte FIT, weiß lackiert, Panel wird in den Aufbaurahmen eingelegt/ Surface-mounted frame for LED panel light FIT, painted white, Panel is inserted into the mounting frame	628 x 628 x 45	white	78,40

**EINBAURAHMEN FIT/RECESSED MOUNTING FRAME FIT**

ART. NR./CODE	INFO	L x B x H/L x W x H	DA L x B/ID L x W	FARBE/COLOUR	PREIS/PRICE
757-625ebr	Einbaurahmen für gesägte Deckenöffnungen. z.B. Trockenbaudecke etc. Für LED Pannelleuchte FIT Panel wird in den Einbaurahmen eingelegt/ Installation frame for sawn ceiling openings, e.g. drywall ceilings etc. For LED FIT Panel panel light is inserted into the installation frame	660 x 660 x 85,5	645 x 645	white	65,70

**AUFBAURAHMEN FIT LONG/SURFACE-MOUNTED FRAME FIT LONG**

ART. NR./CODE	INFO	L x B x H/L x W x H	FARBE/COLOUR	PREIS/PRICE
757-1250abr	Aufbaurahmen für LED Pannelleuchte FIT LONG, weiß lackiert, Panel wird in den Aufbaurahmen eingelegt/ Surface-mounted frame for LED panel light FIT LONG, painted white, Panel is inserted into the mounting frame	1251 x 318 x 45	white	101,70

**EINBAURAHMEN FIT LONG/INSTALLATION FRAME RECESSED FIT LONG**

ART. NR./CODE	INFO	L x B x H/L x W x H	DA L x B/ID L x W	FARBE/COLOUR	PREIS/PRICE
757-1250ebr	Einbaurahmen für gesägte Deckenöffnungen. z.B. Trockenbaudecke etc. Für LED Pannelleuchte FIT LONG LED Panel wird in den Einbaurahmen eingelegt/ Installation frame for sawn ceiling openings, e.g. drywall ceilings etc. For LED FIT LONG panel light LED panel is inserted into the mounting frame	1285 x 360 x 88	1270 x 335	white	92,10

**SEILABHÄNGESET/CORD SUSPENSION SET**

ART. NR./CODE	INFO	L	PREIS/PRICE
757-zhuni2	Seilabhängeset 2m für LED Pannelleuchten FIT & FIT LONG, weiß lackiert/ cord suspension set 2m for LED panels FIT & FIT LONG, white coated	2000	24,40

**MONTAGECLIP/MOUNTING CLIP**

ART. NR./CODE	INFO	L x B x H/L x W x H	PREIS/PRICE
757-vestset4	Montageclipset (4 Stk.) für FIT/ Mounting clip set (4pcs.) for FIT	15 x 85 x 70	12,50

**EINSPEISESET/FEED-IN SET**

ART. NR./CODE	INFO	L	QUERSCHNITT/CROSS SECTION	FARBE/COLOUR	PREIS/PRICE
757-bk3w	Einspeiseset für LED Pannelleuchte FIT & FIT LONG bestehend aus: Baldachin weiß inkl. Zugentlastung transp., Baldachin: 80 x 80 x 30 mm/ Power supply set for LED panel light FIT & FIT LONG consisting of: Canopy white incl. Transparent strain relief, Canopy: 80 x 80 x 30 mm	2200	3x 0,75 mm	white	19,10
757-bk5w		2200	5x 0,75 mm	white	26,50





LED Hängeleuchte aus Aluminium, Oberfläche lackiert, Abdeckung mit Mikroprismenoptik, sehr breitstrahlender Indirektanteil, inkl. 2500mm Abhängung und Baldachin, L 500 x B 75 x H 38mm

LED pendant from aluminium, surface laquered, cover with micro-prismatic optik, very wide indirect light beam, incl. 2500mm suspension and canopy, L 500 x W 75 x H 38mm  
Canopy: Ø 63, H 44

RUBE PDI



ART. NR./CODE	LEISTUNG/POWER	LUMEN	CRI>	KELVIN	L x B x H/L x W x H	AUSFÜHRUNG/DIMM	FARBE/COLOUR	PREIS/PRICE
757-lr1203700s	SYS 35W	3500	80	3000	1195 x 295 x 15	SCHALTBAR/SWITCHABLE	white	327,40
757-lr1203700dali	SYS 35W	3500	80	3000	1195 x 295 x 15	DALI DIMM	white	399,50
757-lr1204700s	SYS 35W	3500	80	4000	1195 x 295 x 15	SCHALTBAR/SWITCHABLE	white	327,40
757-lr1204700dali	SYS 35W	3500	80	4000	1195 x 295 x 15	DALI DIMM	white	399,50
757-lr1203700bs	SYS 35W	3500	80	3000	1195 x 295 x 15	SCHALTBAR/SWITCHABLE	black	327,40
757-lr1203700bdali	SYS 35W	3500	80	3000	1195 x 295 x 15	DALI DIMM	black	399,50
757-lr1204700bs	SYS 35W	3500	80	4000	1195 x 295 x 15	SCHALTBAR/SWITCHABLE	black	327,40
757-lr1204700bdali	SYS 35W	3500	80	4000	1195 x 295 x 15	DALI DIMM	black	399,50
757-lr12031050s	SYS 54W	5800	80	3000	1195 x 295 x 15	SCHALTBAR/SWITCHABLE	white	327,40
757-lr12031050dali	SYS 54W	5800	80	3000	1195 x 295 x 15	DALI DIMM	white	399,50
757-lr12041050s	SYS 54W	5800	80	4000	1195 x 295 x 15	SCHALTBAR/SWITCHABLE	white	327,40
757-lr12041050dali	SYS 54W	5800	80	4000	1195 x 295 x 15	DALI DIMM	white	399,50
757-lr12031050bs	SYS 54W	5800	80	3000	1195 x 295 x 15	SCHALTBAR/SWITCHABLE	black	327,40
757-lr12031050bdali	SYS 54W	5800	80	3000	1195 x 295 x 15	DALI DIMM	black	399,50
757-lr12041050bs	SYS 54W	5800	80	4000	1195 x 295 x 15	SCHALTBAR/SWITCHABLE	black	327,40
757-lr12041050bdali	SYS 54W	5800	80	4000	1195 x 295 x 15	DALI DIMM	black	399,50
757-lr15031050s	SYS 49W	5100	80	3000	1495 x 295 x 15	SCHALTBAR/SWITCHABLE	white	427,30
757-lr15031050dali	SYS 49W	5100	80	3000	1495 x 295 x 15	DALI DIMM	white	499,40
757-lr15041050s	SYS 49W	5100	80	4000	1495 x 295 x 15	SCHALTBAR/SWITCHABLE	white	427,30
757-lr15041050dali	SYS 49W	5100	80	4000	1495 x 295 x 15	DALI DIMM	white	499,40
757-lr15031050bs	SYS 49W	5100	80	3000	1495 x 295 x 15	SCHALTBAR/SWITCHABLE	black	427,30
757-lr15031050bdali	SYS 49W	5100	80	3000	1495 x 295 x 15	DALI DIMM	black	499,40
757-lr15041050bs	SYS 49W	5100	80	4000	1495 x 295 x 15	SCHALTBAR/SWITCHABLE	black	427,30
757-lr15041050bdali	SYS 49W	5100	80	4000	1495 x 295 x 15	DALI DIMM	black	499,40
757-lr15031400s	SYS 62W	6500	80	3000	1495 x 295 x 15	SCHALTBAR/SWITCHABLE	white	427,30
757-lr15031400dali	SYS 62W	6500	80	3000	1495 x 295 x 15	DALI DIMM	white	501,10
757-lr15041400s	SYS 62W	6500	80	4000	1495 x 295 x 15	SCHALTBAR/SWITCHABLE	white	427,30
757-lr15041400dali	SYS 62W	6500	80	4000	1495 x 295 x 15	DALI DIMM	white	501,10
757-lr15031400bs	SYS 62W	6500	80	3000	1495 x 295 x 15	SCHALTBAR/SWITCHABLE	black	427,30
757-lr15031400bdali	SYS 62W	6500	80	3000	1495 x 295 x 15	DALI DIMM	black	499,40
757-lr15041400bs	SYS 62W	6500	80	4000	1495 x 295 x 15	SCHALTBAR/SWITCHABLE	black	427,30
757-lr15041400bdali	SYS 62W	6500	80	4000	1495 x 295 x 15	DALI DIMM	black	499,40







































# TECNICO OUTDOOR



TECNICO OUTDOOR



# PRODUKTÜBERSICHT TECNICO OUTDOOR

 <b>IVY ROUND R</b> S. 174/P. 174	 <b>CHICCO ROUND</b> S. 174/P. 174	 <b>IVY SQUARE R</b> S. 176/P. 176	 <b>CHICCO SQUARE</b> S. 176/P. 176	 <b>NONA MINI</b> S. 179/P. 179
 <b>NONA</b> S. 179/P. 179	 <b>FORIS SD</b> S. 181/P. 181	 <b>WILLIAM SD</b> S. 181/P. 181	 <b>FORIS W</b> S. 183/P. 183	 <b>FORIS DOUBLE W</b> S. 183/P. 183
 <b>WILLIAM W</b> S. 183/P. 183	 <b>SOPO ROUND M</b> S. 185/P. 185	 <b>SOPO ROUND L</b> S. 185/P. 185	 <b>SOPO SQUARE M</b> S. 185/P. 185	 <b>SOPO SQUARE L</b> S. 185/P. 185
 <b>TURN 2 SD GU10</b> S. 186/P. 186	 <b>FYNN O SD</b> S. 186/P. 186	 <b>LINE 25W</b> S. 188/P. 188	 <b>LINE 25 DOUBLE</b> S. 188/P. 188	 <b>LINE 50W</b> S. 188/P. 188
 <b>LINE 50 DOUBLE</b> S. 188/P. 188	 <b>WADO W</b> S. 190/P. 190	 <b>WADO DOUBLE W</b> S. 190/P. 190	 <b>CORBA ROUND W</b> S. 191/P. 191	 <b>CORBA SQUARE W</b> S. 191/P. 191
 <b>NEXT</b> S. 192/P. 192	 <b>BEN ROUND W</b> S. 192/P. 192	 <b>BEN SQUARE W</b> S. 192/P. 192	 <b>PARE W</b> S. 194/P. 194	 <b>NELL W</b> S. 195/P. 195
 <b>FOCO W</b> S. 195/P. 195	 <b>ZEON W</b> S. 196/P. 196	 <b>FYNN C W</b> S. 196/P. 196	 <b>KODA TEN ONE</b> S. 198/P. 198	 <b>KODA TEN TWO</b> S. 198/P. 198

# INDEX TECNICO OUTDOOR

 <b>TEN STRETTO</b> S. 198/P. 198	 <b>KODA TWENTY ONE</b> S. 198/P. 198	 <b>KODA TWENTY TWO</b> S. 198/P. 198	 <b>KODA THIRTY ONE</b> S. 199/P. 199	 <b>KODA THIRTY TWO</b> S. 199/P. 199
 <b>CADO MINI W</b> S. 200/P. 200	 <b>CADO W</b> S. 201/P. 201	 <b>MONA MINI F</b> S. 204/P. 204	 <b>MONA F</b> S. 204/P. 204	 <b>YARA ROUND F</b> S. 206/P. 206
 <b>YARA SQUARE F</b> S. 206/P. 206	 <b>ZEON F</b> S. 207/P. 207	 <b>BOOPER F</b> S. 208/P. 208	 <b>ALIAR F</b> S. 208/P. 208	 <b>WILLIAM F</b> S. 211/P. 211
 <b>FYNN CP F</b> S. 211/P. 211	 <b>CHOPA F</b> S. 214/P. 214	 <b>HARK</b> S. 214/P. 214	 <b>FORIS F</b> S. 215/P. 215	 <b>MICRO RODIO SYM.</b> S. 216/P. 216
 <b>MICRO RODIO L SYM.</b> S. 216/P. 216	 <b>MINI RODIO SYM.</b> S. 217/P. 217	 <b>RODIO SYM LED</b> S. 217/P. 217	 <b>ZUBEHÖR/ACCESSOIRES</b> S. 218/P. 218	



# SCHUTZZONEN

- ZONE 1 | IP23
- ZONE 2 | IP44
- ZONE 3 | IP65
- ZONE 4 | IP67

**IP23**  
geschützt gegen Sprühwasser/  
Protected against water spray

**IP44**  
geschützt gegen Spritzwasser/  
Protected against splash water

**IP65**  
geschützt gegen Strahlwasser/  
Protected against water jets

**IP67**  
geschützt gegen zeitweises Eintauchen/  
Protected against temporary immersion

# PROTECTION ZONES

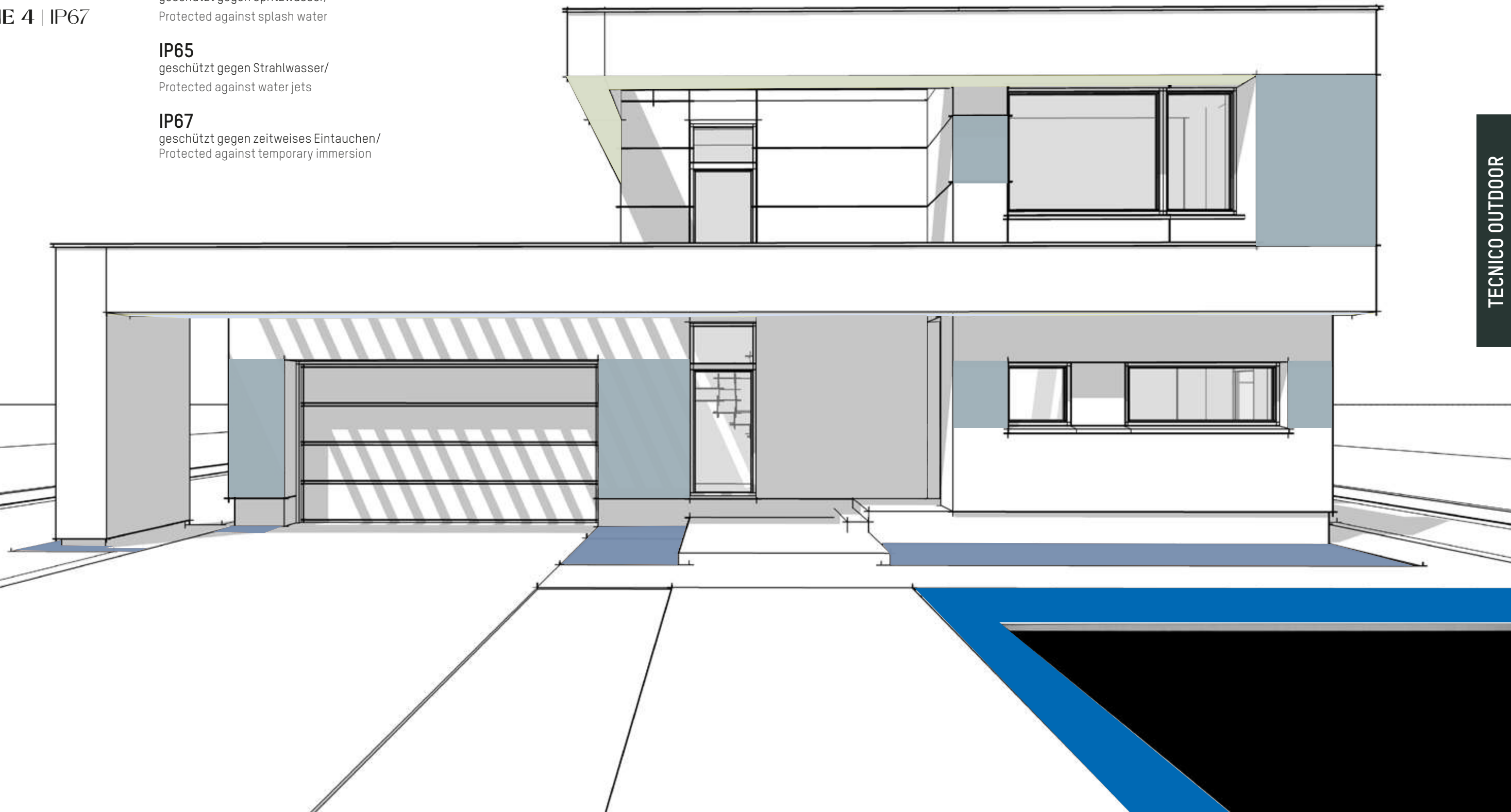



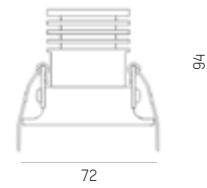

Einbaustrahler, Aluminiumdruckguss, Feinstruktur matt pulverbeschichtet, rund, mit zurückversetzter Lichtquelle, exkl. Konverter

Recessed spotlight, die-cast aluminium, powder-coated, with recessed light source, 2 beam angles, excl. driver

**IVY ROUND R**

ART. NR./CODE	LEISTUNG/POWER	mA	LUMEN	CRI>	KELVIN	Ø x ET/Ø x ID	⌀	FARBE/COLOUR	REFL.	PREIS/PRICE
472-0260790203005	LED 7W	200	700	90	3000	72 x 94	60	white	20°	59,00
472-0260790203006	LED 7W	200	660	90	3000	72 x 94	60	black	20°	59,00
472-0260790403005	LED 7W	200	640	90	3000	72 x 94	60	white	40°	59,00
472-0260790403006	LED 7W	200	630	90	3000	72 x 94	60	black	40°	59,00

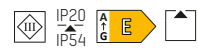

**KONVERTER/DRIVER**

ART. NR./CODE	INFO	WATT	mA	V DC	V AC	L x B x H/L x W x H	FARBE/COLOUR	PREIS/PRICE
30-880006	on/off	8,5W	200	44	230	156 x 43 x 30	white	13,00
24-151395	DALI	9W	180	50	230	108 x 52 x 22	white	58,20

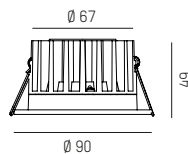

Einbaustrahler, Aluminiumdruckguss, Feinstruktur matt pulverbeschichtet, zurückversetzte Lichtquelle, exkl. Konverter

Recessed spotlight, die-cast aluminium, powder-coated, recessed light source, excl. driver

**CHICCO ROUND**

ART. NR./CODE	LEISTUNG/POWER	mA	LUMEN	CRI>	KELVIN	Ø x ET/Ø x ID	⌀	FARBE/COLOUR	REFL.	PREIS/PRICE
308-0010790302704	LED 7W	350	530	90	2700	90 x 80	78	silver	30°	54,00
308-0010790302705	LED 7W	350	540	90	2700	90 x 80	78	white	30°	54,00
308-0010790302706	LED 7W	350	510	90	2700	90 x 80	78	black	30°	54,00
308-0010790303004	LED 7W	350	560	90	3000	90 x 80	78	silver	30°	54,00
308-0010790303005	LED 7W	350	590	90	3000	90 x 80	78	white	30°	54,00
308-0010790303006	LED 7W	350	560	90	3000	90 x 80	78	black	30°	54,00



**KONVERTER/DRIVER**

ART. NR./CODE	INFO	WATT	mA	V DC	V AC	L x B x H/L x W x H	FARBE/COLOUR	PREIS/PRICE
30-880006	on/off	8,5W	200	44	230	156 x 43 x 30	white	13,00
24-151403	DALI	17W	350	49	230	111 x 52 x 22	white	57,20

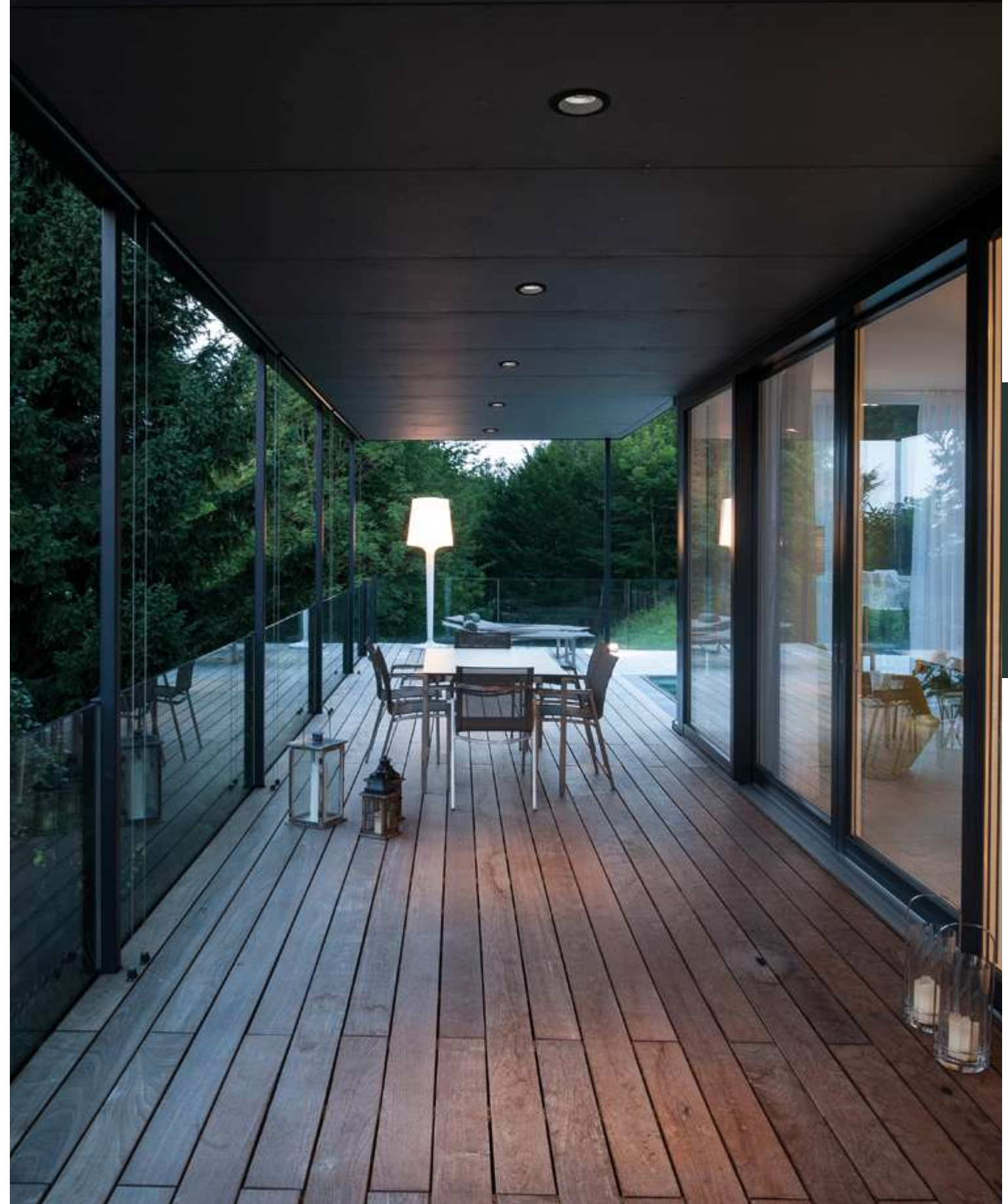



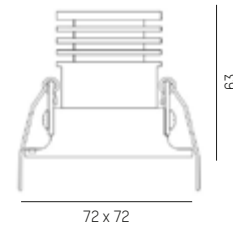

Einbaustrahler, Aluminiumdruckguss, Feinstruktur matt pulverbeschichtet, runder Deckenausschnitt, zurückversetzte Lichtquelle, exkl. Konverter

Recessed spotlight, die-cast aluminium, powder-coated, recessed light source, excl. driver

## IVY SQUARE

ART. NR./CODE	LEISTUNG/POWER	mA	LUMEN	CRI>	KELVIN	L x B x ET/L x W x ID	Ø	FARBE/COLOUR	REFL.	PREIS/PRICE
472-0270790203005	LED 7W	200	700	90	3000	72 x 72 x 94	60	white	20°	64,00
472-0270790203006	LED 7W	200	660	90	3000	72 x 72 x 94	60	black	20°	64,00
472-0270790403005	LED 7W	200	640	90	3000	72 x 72 x 94	60	white	40°	64,00
472-0270790403006	LED 7W	200	630	90	3000	72 x 72 x 94	60	black	40°	64,00



## KONVERTER/DRIVER



ART. NR./CODE	INFO	WATT	mA	V DC	V AC	L x B x H/L x W x H	FARBE/COLOUR	PREIS/PRICE
30-880006	on/off	8,5W	200	44	230	156 x 43 x 30	white	13,00
24-151395	DALI	9W	180	50	230	108 x 52 x 22	white	58,20

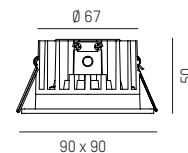

Einbaustrahler, Aluminiumdruckguss, Feinstruktur matt pulverbeschichtet, zurückversetzte Lichtquelle, exkl. Konverter

Recessed spotlight, die-cast aluminium, powder-coated, with recessed light source, 2 beam angles, excl. driver

## CHICCO SQUARE

ART. NR./CODE	LEISTUNG/POWER	mA	LUMEN	CRI>	KELVIN	L x B x ET/L x W x ID	Ø	FARBE/COLOUR	REFL.	PREIS/PRICE
308-0020790302704	LED 7W	350	530	90	2700	90 x 90 x 80	78	silver	30°	54,00
308-0020790302705	LED 7W	350	540	90	2700	90 x 90 x 80	78	white	30°	54,00
308-0020790302706	LED 7W	350	510	90	2700	90 x 90 x 80	78	black	30°	54,00
308-0020790303004	LED 7W	350	560	90	3000	90 x 90 x 80	78	silver	30°	54,00
308-0020790303005	LED 7W	350	590	90	3000	90 x 90 x 80	78	white	30°	54,00
308-0020790303006	LED 7W	350	560	90	3000	90 x 90 x 80	78	black	30°	54,00



## KONVERTER/DRIVER



ART. NR./CODE	INFO	WATT	mA	V DC	V AC	L x B x H/L x W x H	FARBE/COLOUR	PREIS/PRICE
30-880006	on/off	15W	350	44	230	156 x 43 x 30	white	13,00
24-151403	DALI	17W	350	49	230	111 x 52 x 22	white	57,20

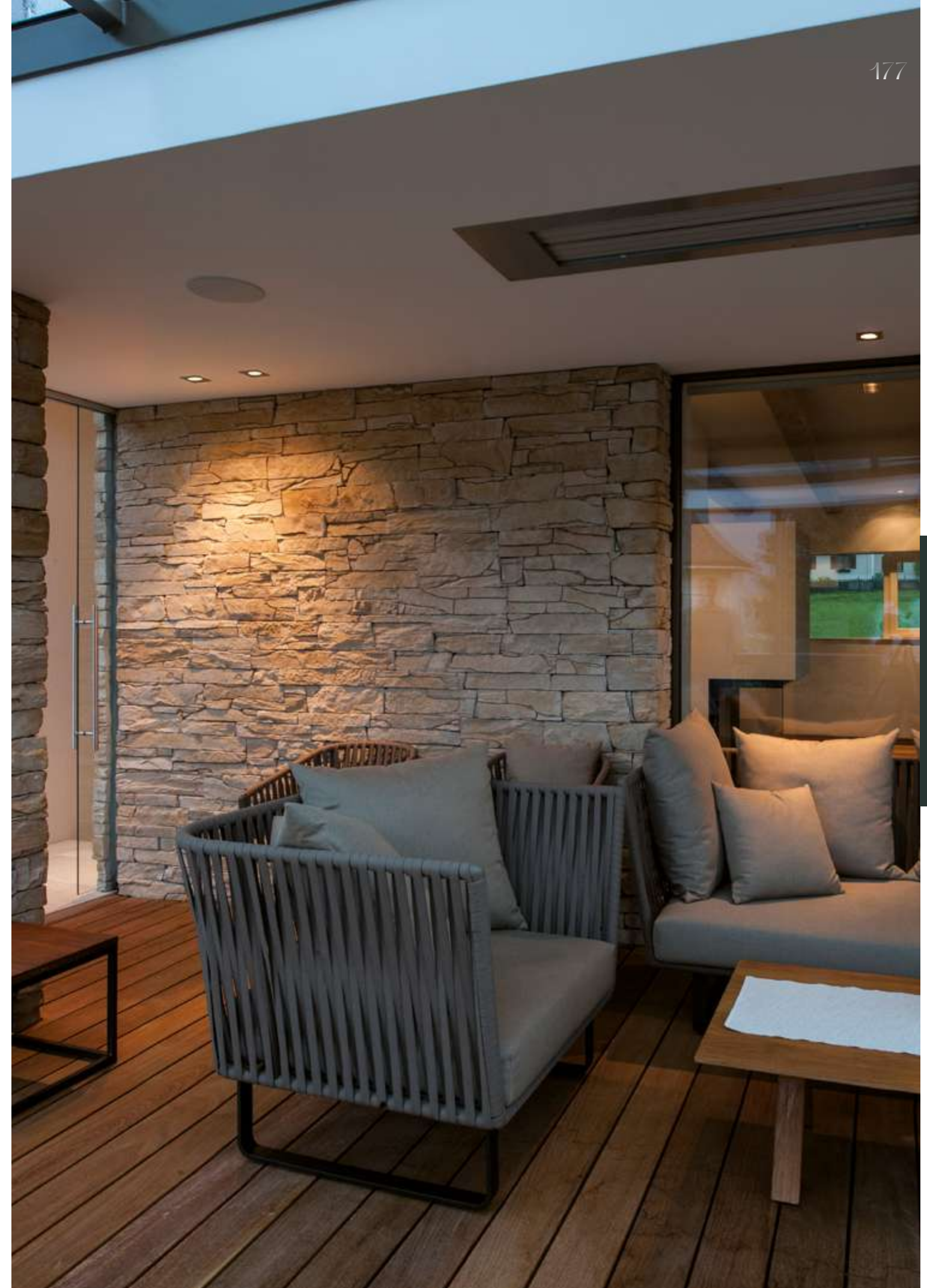





Deckenaufbauleuchte, gehärtetes Glas, Aluminium, low glare durch nach innen versetzte Reflektoren

Surface-mounted ceiling luminaire, tempered glass, aluminium, low glare due to reflectors offset inwards

NEW

## NONA MINI



ART. NR./CODE	LEISTUNG/POWER	LUMEN	CRI>	KELVIN	Ø x H	FARBE/COLOUR	REFL.	PREIS/PRICE
333-00044	SYS 12W	1200	80	3000	182 x 61	anthracite	20°	149,00

IP65 IK10 A D UGR<6



Deckenaufbauleuchte, gehärtetes Glas, Aluminium, low glare durch nach innen versetzte Reflektoren, DALI dimmbar

Surface-mounted ceiling luminaire, tempered glass, aluminium, low glare due to reflectors offset inwards, DALI dimmable

NEW

## NONA



ART. NR./CODE	LEISTUNG/POWER	LUMEN	CRI>	KELVIN	Ø x H	FARBE/COLOUR	REFL.	PREIS/PRICE
333-00045	SYS 25W	1750	80	3000	228 x 74	anthracite	20°	199,00

IP65 IK10 A F DALI UGR<6





Deckenaufbauleuchte, Aluminium, neu mit CCT Chip, Ausstrahlwinkel 55° oder 35°, 2700K oder 3000K über DIP-Switch einstellbar

Surface-mounted ceiling light, aluminium, new with CCT chip, beam angle 55° or 35°, 2700K or 3000K adjustable via dipswitch

NEW

**FORIS SD**



ART. NR./CODE	LEISTUNG/POWER	LUMEN	CRI>	KELVIN	Ø x H	FARBE/COLOUR	REFL.	PREIS/PRICE
333-00030	SYS 11W	860/920	90	2700/3000	100 x 126	anthracite	60°	199,00

IP65 IK06



**REFLEKTOR/REFLECTOR**

ART. NR./CODE	FARBE/COLOUR	REFL.	PREIS/PRICE
333-A00030	silver	35°	19,00
333-A00031	silver	55°	19,00



**ENDBLENDUNGSRING/SHUTTER RING**

ART. NR./CODE	FARBE/COLOUR	PREIS/PRICE
341-7000	anthracite	49,00



**FORIS BEAM**

ART. NR./CODE	FARBE/COLOUR	PREIS/PRICE
333-A00032	anthracite	15,00



TECNICO OUTDOOR



Deckenaufbauleuchte, Aluminium, pulverbeschichtet, Glas transparent oder milchig

Surface-mounted ceiling light, aluminium, powder-coated, transparent or milky glass

NEW

**WILLIAM SD**



ART. NR./CODE	LM/BULB	FASSUNG/SOCKET	V AC	Ø x H/Ø x H	GLAS/GLASS	FARBE/COLOUR	PREIS/PRICE
333-00019	RETROFIT	E27	230	120 x 205	clear	anthracite brushed	129,00
333-00022	RETROFIT	E27	230	120 x 205	white	anthracite brushed	129,00

IP65





Wand-/ Deckenaufbauleuchte, Aluminiumdruckguss, opaler Diffusor aus Polycarbonat, doppelter Kabelausschlus, inkl. Konverter

Wall/ceiling luminaire, die-cast aluminium, opal polycarbonate diffuser, double cable outlet, incl. driver

NEW

## FORIS W

ART. NR./CODE	LEISTUNG/POWER	LUMEN	CRI>	KELVIN	Ø x B x H/Ø x W x H	FARBE/COLOUR	REFL.	PREIS/PRICE
333-00031	SYS 11W	900/970	90	2700/3000	100 x 146 x 119	anthracite	60°	239,00



NEW

## FORIS DOUBLE W

ART. NR./CODE	LEISTUNG/POWER	LUMEN	CRI>	KELVIN	Ø x B x H/Ø x W x H	FARBE/COLOUR	REFL.	PREIS/PRICE
333-00032	SYS 21W	1800/1950	90	2700/3000	100 x 146 x 232	anthracite	60°	289,00



## REFLEKTOR/REFLECTOR

ART. NR./CODE	FARBE/COLOUR	REFL.	PREIS/PRICE
333-A00030	silver	35°	19,00
333-A00031	silver	55°	19,00



## ENDBLENDUNGSRING/SHUTTER RING

ART. NR./CODE	FARBE/COLOUR	PREIS/PRICE
341-7000	anthracite	49,00



## FORIS BEAM

ART. NR./CODE	FARBE/COLOUR	PREIS/PRICE
333-A00032	anthracite	15,00



TECNICO OUTDOOR



Wandaufbauleuchte, Aluminium, pulverbeschichtet, Glas transparent oder milchig

Surface-mounted wall light, aluminium, powder-coated, transparent or milky glass

NEW

## WILLIAM W

ART. NR./CODE	LM/BULB	FASSUNG/SOCKET	V AC	Ø x B x H/Ø x W x H	GLAS/GLASS	FARBE/COLOUR	PREIS/PRICE
333-00020	RETROFIT	E27	230	120 x 159 x 214	clear	anthracite brushed	139,00
333-00023	RETROFIT	E27	230	120 x 159 x 214	white	anthracite brushed	139,00







Wand-/ Deckenaufbauleuchte, Aluminiumdruckguss, opaler Diffusor aus Polycarbonat, doppelter Kabelaussch, inkl. Konverter

Wall/ceiling luminaire, die-cast aluminium, opal polycarbonate diffuser, double cable outlet, incl. driver

### SOPO ROUND M

ART. NR./CODE	LEISTUNG/POWER	LUMEN	CRI>	KELVIN	Ø x T	FARBE/COLOUR	PREIS/PRICE
100-r24190110	SYS 25W	2570	80	3000	240 x 45	anthracite	175,00
100-r24190740	SYS 25W	2570	80	3000	240 x 45	silver	175,00

### SOPO ROUND L

ART. NR./CODE	LEISTUNG/POWER	LUMEN	CRI>	KELVIN	Ø x T	FARBE/COLOUR	PREIS/PRICE
100-r30190110	SYS 30W	2860	80	3000	300 x 49	anthracite	229,00
100-r30190740	SYS 30W	2860	80	3000	300 x 49	silver	229,00



Wand-/ Deckenaufbauleuchte, Aluminiumdruckguss, opaler Diffusor aus Polycarbonat, doppelter Kabelaussch, inkl. Konverter

Wall/ceiling luminaire, die-cast aluminium, opal polycarbonate diffuser, double cable outlet, incl. driver

### SOPO SQUARE M

ART. NR./CODE	LEISTUNG/POWER	LUMEN	CRI>	KELVIN	L x B x T/L x W x D	FARBE/COLOUR	PREIS/PRICE
100-q24190110	SYS 25W	2755	80	3000	240 x 240 x 45	anthracite	175,00
100-q24190740	SYS 25W	2755	80	3000	240 x 240 x 45	silver	175,00

### SOPO SQUARE L

ART. NR./CODE	LEISTUNG/POWER	LUMEN	CRI>	KELVIN	L x B x T/L x W x D	FARBE/COLOUR	PREIS/PRICE
100-q30190110	SYS 30W	2950	80	3000	300 x 300 x 49	anthracite	229,00
100-q30190740	SYS 30W	2950	80	3000	300 x 300 x 49	silver	229,00

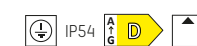





Aufbaustrahler, Aluminium geätzt, 90° schwenkbar  
Surface-mounted spotlight, aluminium brushed or painted, 90° swivelling

### TURN 2 SD GU10



ART. NR./CODE	LM/BULB	FASSUNG/SOCKET	V AC	B x H x T/W x H x D	FARBE/COLOUR	PREIS/PRICE
472-256012	RETROFIT	GU10	230	88 x 90 x 115	silver	129,00
472-256011	RETROFIT	GU10	230	88 x 90 x 115	anthracite	129,00



### LEUCHTMITTEL/LIGHT SOURCE

Weitere Leuchtmittel S./additional light sources P. 290

ART. NR./CODE	INFORMATION	PREIS/PRICE
30-752517	Core Pro LED Spot, GU10,5W, 827 Kelvin, 36° Austrahlwinkel/beam angle	6,50



Aufbauleuchte, Aluminiumdruckguss, pulverbeschichtet, Diffusor aus opalem Acryl, AC-LED  
Surface-mounted luminaire, die-cast aluminium, powder-coated, opal acrylic diffuser, AC LED

### FYNN 0 SD



ART. NR./CODE	LEISTUNG/POWER	LUMEN	CRI>	KELVIN	B x H x T/W x H x D	FARBE/COLOUR	PREIS/PRICE
472-260056w	SYS 10W	790	90	3000	100 x 100 x 112	white	159,00
472-260056s	SYS 10W	790	90	3000	100 x 100 x 112	silver	159,00
472-260056ag	SYS 10W	790	90	3000	100 x 100 x 112	anthracite	159,00

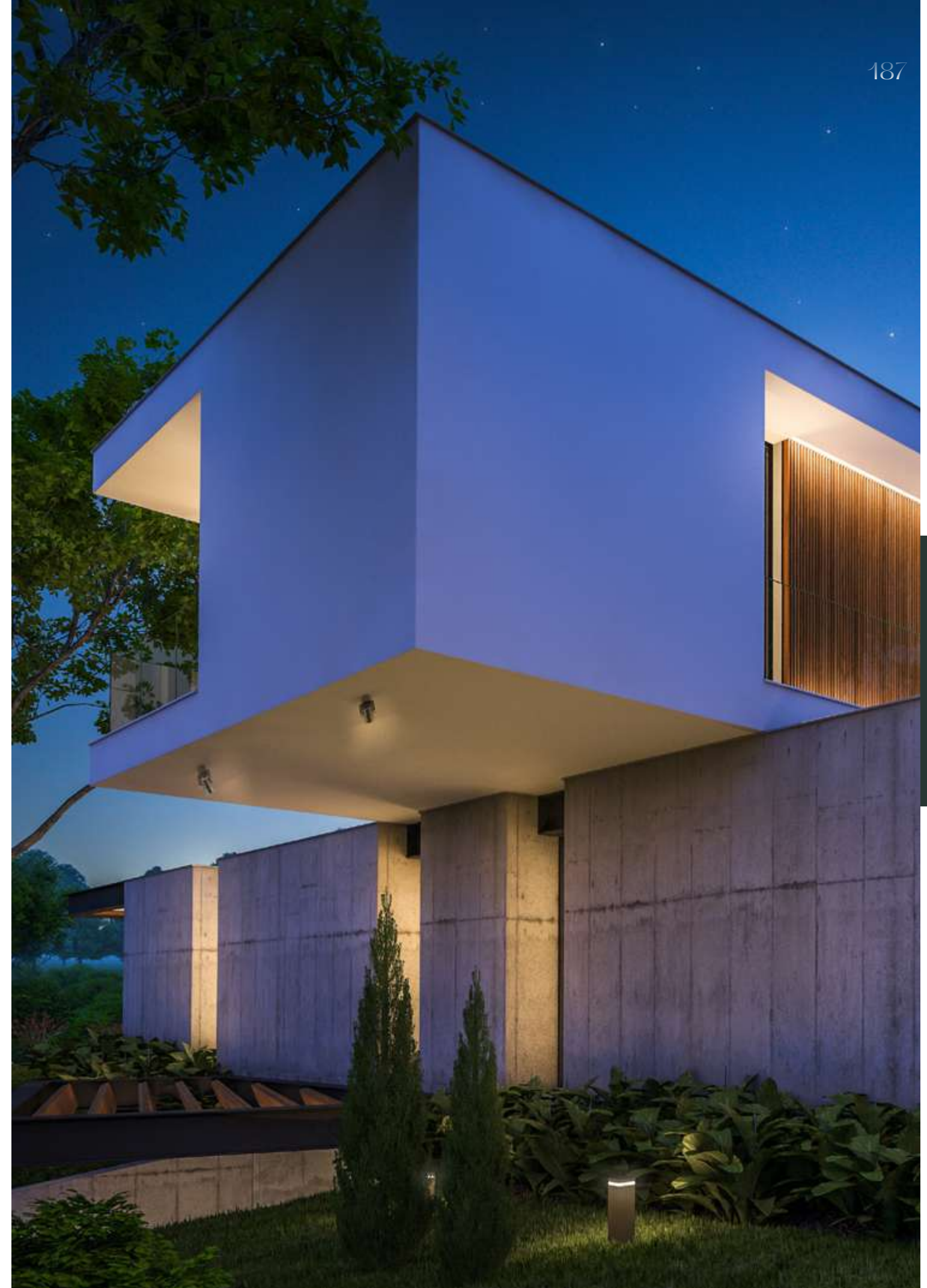





NEW

Wandaufbauleuchte, Aluminium, pulverbeschichtet, up/down oder up&down, 2700K oder 3000K über DIP-Switch einstellbar, Durchgangsverdrahtung, Connect Terminal

Surface-mounted wall light, aluminium, powder-coated, up/down or up&down, 2700K or 3000K adjustable via dipswitch, through-wiring, connect terminal

## LINE 25W



ART. NR./CODE	LEISTUNG/POWER	LUMEN	CRI>	KELVIN	L x B x H/L x W x H	FARBE/COLOUR	PREIS/PRICE
333-00016	SYS 7W	1200/1050	80	2700/3000	250 x 60 x 60	anthracite	149,00

## LINE 25 DOUBLE



ART. NR./CODE	LEISTUNG/POWER	LUMEN	CRI>	KELVIN	L x B x H/L x W x H	FARBE/COLOUR	PREIS/PRICE
333-00015	SYS 15W	2400/2100	80	2700/3000	250 x 60 x 60	anthracite	179,00



## LINE 50W



ART. NR./CODE	LEISTUNG/POWER	LUMEN	CRI>	KELVIN	L x B x H/L x W x H	FARBE/COLOUR	PREIS/PRICE
333-00018	SYS 15W	1800/1500	80	2700/3000	500 x 60 x 60	anthracite	199,00

## LINE 50 DOUBLE



ART. NR./CODE	LEISTUNG/POWER	LUMEN	CRI>	KELVIN	L x B x H/L x W x H	FARBE/COLOUR	PREIS/PRICE
333-00017	SYS 20W	3550/3000	80	2700/3000	500 x 60 x 60	anthracite	249,00







Wandaufbauleuchte, Aluminium, optional mit antiglare cover, Lichtaustritt direkt/ indirekt, DALI2/

Surface-mounted wall light, aluminium, optionally with antiglare cover, direct/ indirect light emission, DALI2



#### BLENDEN/BLINDS

ART. NR./CODE	FARBE/COLOUR	PREIS/PRICE
333-A00046	■ anthracite	29,00

NEW

#### CORBA ROUND W direkt-indirekt/direct-indirect

ART. NR./CODE	LEISTUNG/POWER	LUMEN	CRI>	KELVIN	L x B x H/L x W x H	FARBE/COLOUR	REFL.	PREIS/PRICE
333-00046	SYS 24W	1180	90	■ 3000	100 x 100 x 220	■ anthracite	36°	299,00



#### BLENDEN/BLINDS

ART. NR./CODE	FARBE/COLOUR	PREIS/PRICE
333-A00048	■ anthracite	29,00

NEW

#### CORBA SQUARE W direkt-indirekt/direct-indirect

ART. NR./CODE	LEISTUNG/POWER	LUMEN	CRI>	KELVIN	L x B x H/L x W x H	FARBE/COLOUR	REFL.	PREIS/PRICE
333-00048	SYS 24W	1180	90	■ 3000	100 x 100 x 220	■ anthracite	36°	299,00



Wandaufbauleuchte, Aluminium, CCT Switch 2700K/3000K, Ausstrahlwinkel 15° oder 36°, Lichtaustritt direkt/indirekt, Connect Terminal

Surface-mounted wall light, aluminium, CCT switch 2700K/3000K, beam angle 15° or 36°, direct/indirect light emission, Connect terminal

NEW

#### WADO W direkt/direct

ART. NR./CODE	LEISTUNG/POWER	LUMEN	CRI>	KELVIN	L x B x H/L x W x H	FARBE/COLOUR	REFL.	PREIS/PRICE
333-00050	SYS 12W	945/1020	90	■ 2700/■ 3000	110 x 110 x 120	■ anthracite	36°	209,00



NEW

#### WADO DOUBLE W direkt-indirekt/direct-indirect

ART. NR./CODE	LEISTUNG/POWER	LUMEN	CRI>	KELVIN	L x B x H/L x W x H	FARBE/COLOUR	REFL.	PREIS/PRICE
333-00051	SYS 20W	1890/2035	90	■ 2700/■ 3000	110 x 110 x 120	■ anthracite	36°	259,00



#### REFLEKTOR/REFLECTOR

ART. NR./CODE	FARBE/COLOUR	REFL.	PREIS/PRICE
333-A00050	■ silver	15°	19,00
333-A00051	■ silver	36°	19,00





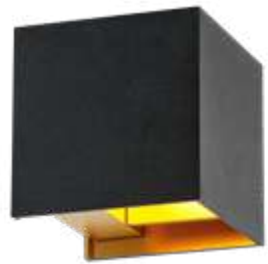

Wandleuchte, Aluminium, Feinstruktur matt pulverbeschichtet, schwenkbarer Doppelreflektor für individuelle Lichtbildgestaltung, Lichtaustritt direkt/ indirekt, inkl. Konverter

Wall luminaire, aluminium, powder-coated, tiltable cover for individual light distribution, direct/indirect beam, incl. driver

### NEXT W direkt-indirekt/direct-indirect



ART. NR./CODE	LEISTUNG/POWER	LUMEN	CRI>	KELVIN	B x H x T/W x H x D	FARBE/COLOUR	PREIS/PRICE
472-291008w	SYS 7W	210	90	3000	100 x 100 x 100	white	249,00
472-291008s	SYS 7W	210	90	3000	100 x 100 x 100	silver	249,00
472-291008bgng1	SYS 7W	210	90	3000	100 x 100 x 100	black/gold	289,00
472-291008ag	SYS 7W	210	90	3000	100 x 100 x 100	anthracite	249,00



Wandleuchte, Aluminiumdruckguss, pulverbeschichtet, Lichtaustritt direkt/ indirekt, inkl. Konverter

Wall luminaire, aluminium, powder-coated, round, direct/indirect beam, incl. driver

### BEN ROUND W direkt-indirekt/direct-indirect



ART. NR./CODE	LEISTUNG/POWER	LUMEN	CRI>	KELVIN	B x H x T/W x H x D	FARBE/COLOUR	PREIS/PRICE
472-0050890003005	SYS 9W	230	90	3000	90 x 250 x 95	white	269,00
472-0050890003004	SYS 9W	230	90	3000	90 x 250 x 95	silver	269,00
472-0050890003011	SYS 9W	230	90	3000	90 x 250 x 95	anthracite	269,00



Wandleuchte, Aluminium, Feinstruktur matt pulverbeschichtet, Lichtaustritt direkt/ indirekt, inkl. Konverter

Wall luminaire, aluminium, matt powder-coated with fine textured paint, rectangular, direct/indirect beam, incl. driver

### BEN SQUARE W direkt-indirekt/direct-indirect



ART. NR./CODE	LEISTUNG/POWER	LUMEN	CRI>	KELVIN	B x H x T/W x H x D	FARBE/COLOUR	PREIS/PRICE
472-0060890003004	SYS 9W	360	90	3000	80 x 200 x 80	silver	219,00
472-0060890003005	SYS 9W	525	90	3000	80 x 200 x 80	white	219,00
472-0060890003011	SYS 9W	320	90	3000	80 x 200 x 80	anthracite	219,00

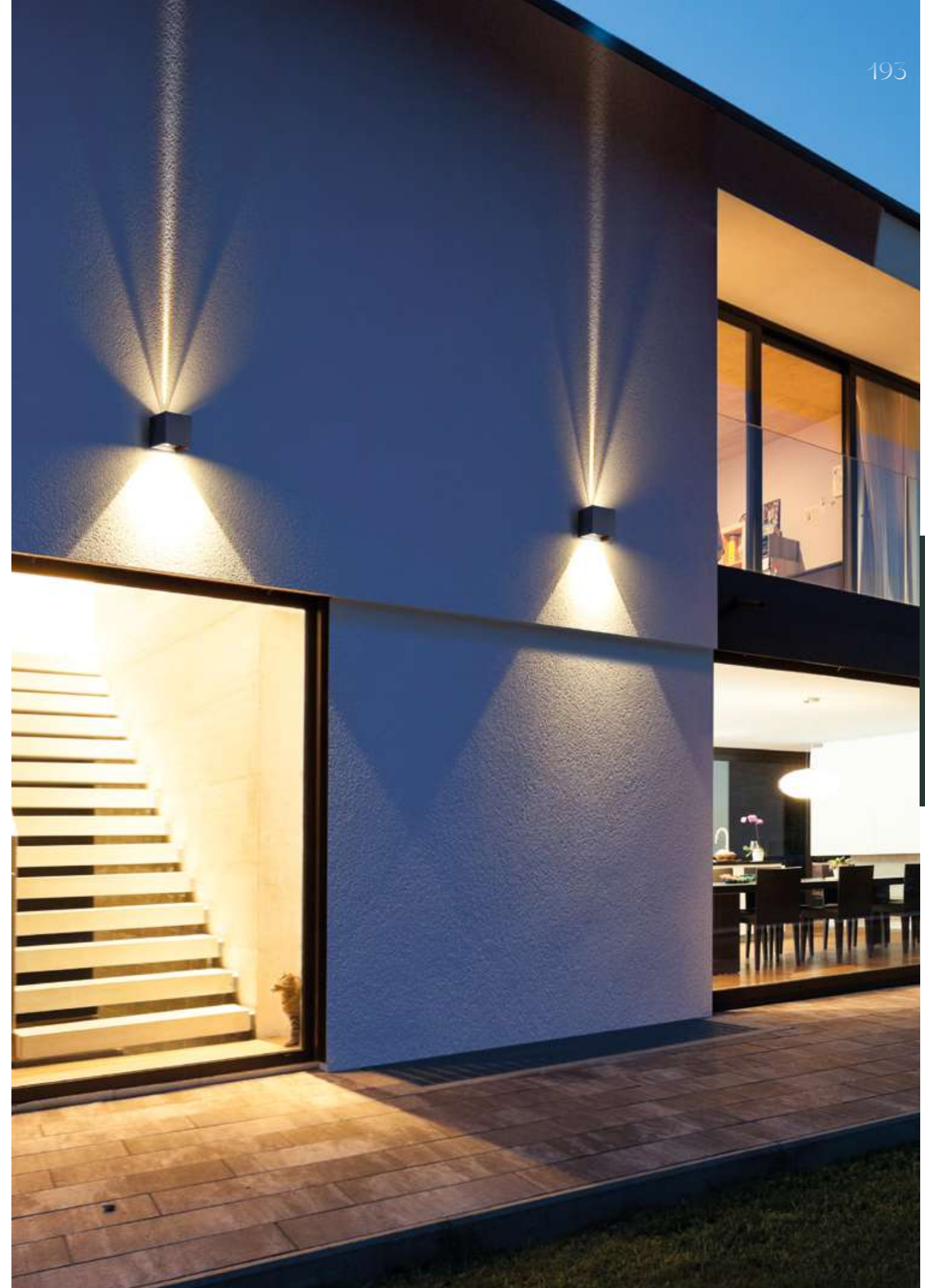





Wandleuchte, Aluminiumdruckguss, Feinstruktur matt pulverbeschichtet, satiniertes Diffusor aus Polycarbonat für homogenen Lichteffect, Lichtaustritt direkt/indirekt, inkl. Konverter

Wall luminaire, die-cast aluminium, powder-coated, satined polycarbonate diffuser for homogeneous lighting effect, direct/indirect beam, incl. driver

**PARE W** direkt-indirekt/direct-indirect



ART. NR./CODE	LEISTUNG/POWER	LUMEN	CRI>	KELVIN	L x B x T/L x W x H	FARBE/COLOUR	REFL.	PREIS/PRICE
100-02190110	SYS 12W	380	90	3000	207 x 60 x 110	anthracite	2x 110°	129,00
100-02190740	SYS 12W	380	90	3000	207 x 60 x 110	silver	2x 110°	129,00



Wandleuchte, Aluminiumdruckguss, pulverbeschichtet, kugelförmig, Linse aus Glas, 80° Ausstrahlwinkel, Lichtaustritt direkt/indirekt, inkl. Konverter

Wall luminaire, die-cast aluminium, powder-coated, spherical shape, glass lens, 80° beam angle, direct/indirect beam, incl. driver

**NELL W** direkt-indirekt/direct-indirect



ART. NR./CODE	LEISTUNG/POWER	LUMEN	CRI>	KELVIN	Ø x T	FARBE/COLOUR	PREIS/PRICE
472-3729050	SYS 7W	325	90	3000	100 x 88	white	239,00
472-3729060	SYS 7W	275	90	3000	100 x 88	black	239,00



Wandleuchte, Aluminiumdruckguss, pulverbeschichtet, klare Glaslinsen für parabolischen Lichteffect, Lichtaustritt direkt/indirekt, inkl. Konverter

Wall luminaire, die-cast aluminium, powder-coated, clear glass lenses for parabolic lighting effect, direct/indirect distribution, incl. driver

**FOCO W** direkt-indirekt/direct-indirect



ART. NR./CODE	LEISTUNG/POWER	LUMEN	CRI>	KELVIN	L x B x H/L x W x H	FARBE/COLOUR	REFL.	PREIS/PRICE
100-01190110	SYS 9W	550	80	3000	121 x 107 x 78	anthracite	2x 100°	149,00
100-01190740	SYS 9W	550	80	3000	121 x 107 x 78	silver	2x 100°	149,00







Wandleuchte, Aluminiumdruckguss, pulverbeschichtet, opaler Diffusor und Klarglasabdeckung, Lichtaustritt indirekt, inkl. Konverter

Wall luminaire, die-cast aluminium, powder-coated, opal diffuser and clear glass cover, indirect beam, incl. driver

### ZEON W



ART. NR./CODE	LEISTUNG/POWER	LUMEN	CRI>	KELVIN	Ø x T/Ø x D	FARBE/COLOUR	PREIS/PRICE
472-0561090003006	SYS 10W	320	90	3000	120 x 90	black	249,00
472-0561090003011	SYS 10W	320	90	3000	120 x 90	anthracite	249,00



Wandleuchte, Aluminiumdruckguss, pulverbeschichtet, Diffusor aus opalem Acryl, AC-LED

Wall luminaire, die-cast aluminium, powder-coated, diffuser of opal acrylic, AC-LED

### FYNN C W



ART. NR./CODE	LEISTUNG/POWER	LUMEN	CRI>	KELVIN	B x H x T/W x H x D	FARBE/COLOUR	PREIS/PRICE
472-260055s	SYS 10W	642	90	3000	100 x 100 x 120	silver	169,00
472-260055ag	SYS 10W	642	90	3000	100 x 100 x 120	anthracite	169,00

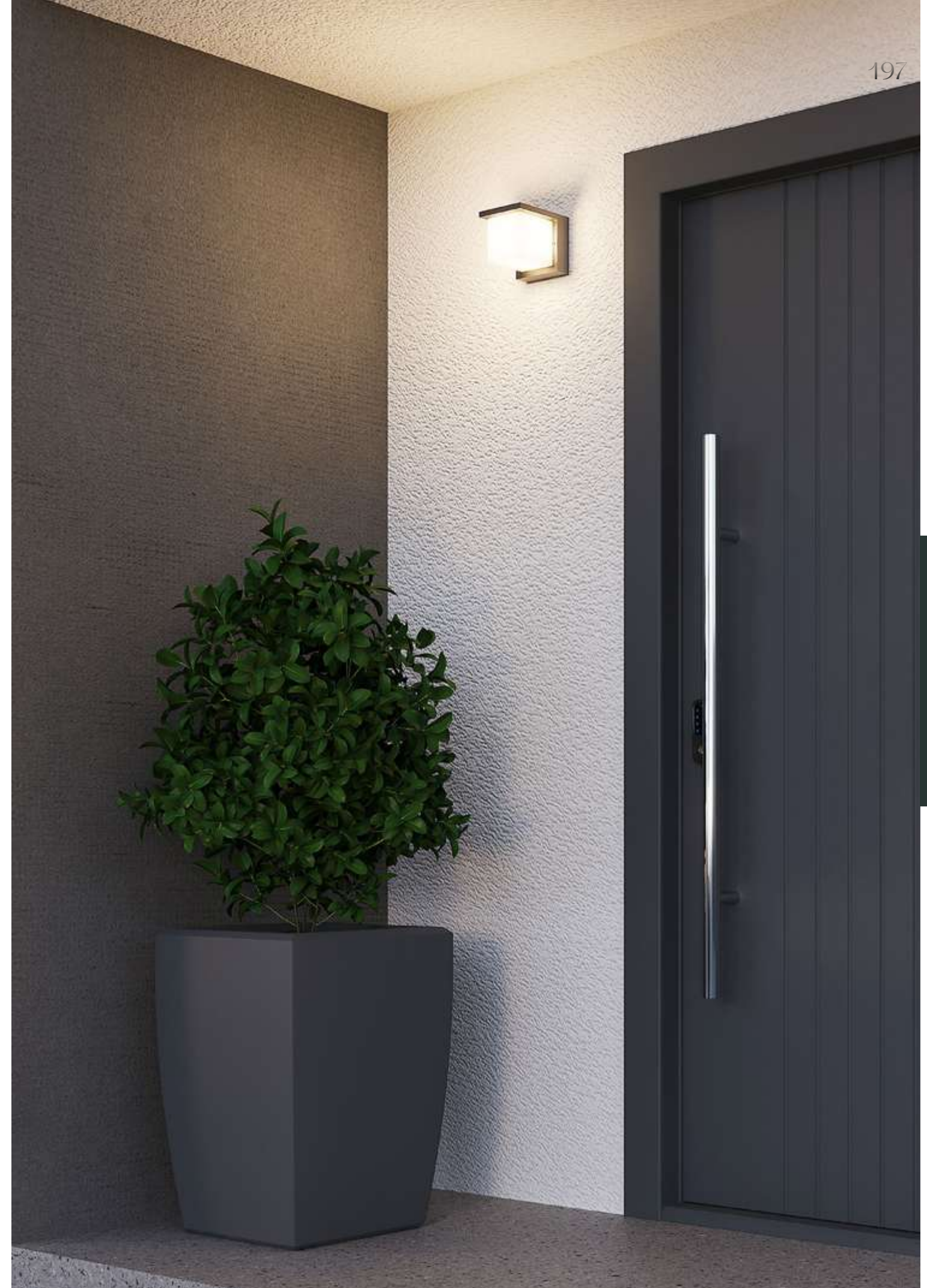





Wandleuchte, Aluminiumdruckguss, lackiert, Diffusor aus transparentem Glas, Dichtung aus Polymerkunststoff, Kühlkörper Aluminium, Schrauben Edelstahl, inkl. Konverter  
 Wall light, die-cast aluminium, lacquered, diffuser made of transparent glass, gasket, aluminium heat sink, stainless steel screws, incl. converters

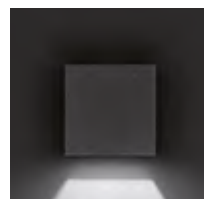
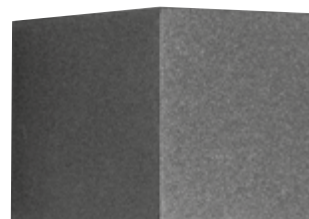

1x breit/  
1x wide

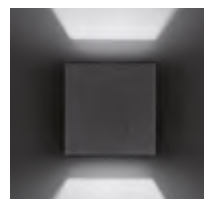

2x breit/  
2x wide

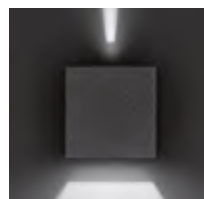

1x breit-1x eng/  
1x wide-1x narrow

**KODA TEN ONE**



ART. NR./CODE	LEISTUNG/POWER	LUMEN	CRI>	KELVIN	L x B x T/L x W x H	FARBE/COLOUR	LICHTAUSTRITT/LIGHT OUTPUT	PREIS/PRICE
333-00055	SYS 4W	100	80	3000	100 x 100 x 100	white	direkt/direct	169,00
333-00054	SYS 4W	100	80	3000	100 x 100 x 100	anthracite	direkt/direct	169,00

**KODA TEN TWO**



ART. NR./CODE	LEISTUNG/POWER	LUMEN	CRI>	KELVIN	L x B x T/L x W x H	FARBE/COLOUR	LICHTAUSTRITT/LIGHT OUTPUT	PREIS/PRICE
333-00057	SYS 6W	2x 96	80	3000	100 x 100 x 100	white	direkt-indirekt/direct-indirect	219,00
333-00056	SYS 6W	2x 96	80	3000	100 x 100 x 100	anthracite	direkt-indirekt/direct-indirect	219,00

**KODA TEN STRETTO**



ART. NR./CODE	LEISTUNG/POWER	LUMEN	CRI>	KELVIN	L x B x T/L x W x H	FARBE/COLOUR	LICHTAUSTRITT/LIGHT OUTPUT	PREIS/PRICE
333-00059	SYS 6W	96+17	80	3000	100 x 100 x 100	white	1x breit-1x eng/1x wide-1x narrow	229,00
333-00058	SYS 6W	96+17	80	3000	100 x 100 x 100	anthracite	1x breit-1x eng/1x wide-1x narrow	229,00

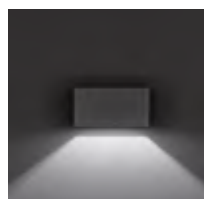
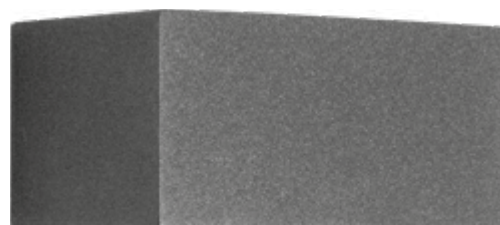

direkt/  
direct

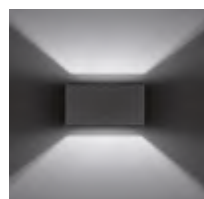

direkt-indirekt/  
direct-indirect

**KODA TWENTY ONE**



ART. NR./CODE	LEISTUNG/POWER	LUMEN	CRI>	KELVIN	L x B x T/L x W x H	FARBE/COLOUR	LICHTAUSTRITT/LIGHT OUTPUT	PREIS/PRICE
333-00061	SYS 11W	492	80	3000	200 x 100 x 100	white	direkt/direct	219,00
333-00060	SYS 11W	492	80	3000	200 x 100 x 100	anthracite	direkt/direct	219,00

**KODA TWENTY TWO**



ART. NR./CODE	LEISTUNG/POWER	LUMEN	CRI>	KELVIN	L x B x T/L x W x H	FARBE/COLOUR	LICHTAUSTRITT/LIGHT OUTPUT	PREIS/PRICE
333-00063	SYS 20W	930	80	3000	200 x 100 x 100	white	direkt-indirekt/direct-indirect	269,00
333-00062	SYS 20W	930	80	3000	200 x 100 x 100	anthracite	direkt-indirekt/direct-indirect	269,00

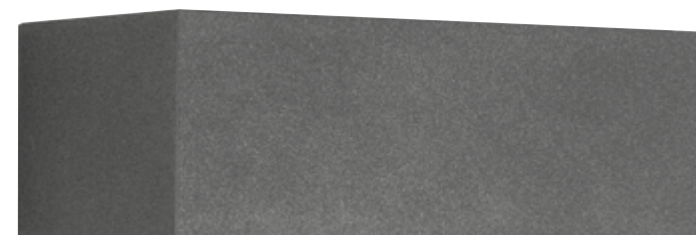

1x breit/  
1x wide

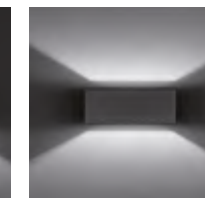

2x breit/  
2x wide

**KODA THIRTY ONE**



ART. NR./CODE	LEISTUNG/POWER	LUMEN	CRI>	KELVIN	L x B x T/L x W x H	FARBE/COLOUR	LICHTAUSTRITT/LIGHT OUTPUT	PREIS/PRICE
333-00065	SYS 20W	936	80	3000	300 x 100 x 100	white	direkt/direct	329,00
333-00064	SYS 20W	936	80	3000	300 x 100 x 100	anthracite	direkt/direct	329,00

**KODA THIRTY TWO**



ART. NR./CODE	LEISTUNG/POWER	LUMEN	CRI>	KELVIN	L x B x T/L x W x H	FARBE/COLOUR	LICHTAUSTRITT/LIGHT OUTPUT	PREIS/PRICE
333-00067	SYS 32W	1532	80	3000	300 x 100 x 100	white	direkt-indirekt/direct-indirect	439,00
333-00066	SYS 32W	1532	80	3000	300 x 100 x 100	anthracite	direkt-indirekt/direct-indirect	439,00







NEW

Wandaufbauleuchte, Aluminium, innen liegende Platine für optimale Entblendung, 2700K oder 3000K über DIP-Switch einstellbar, Durchgangsverdrahtung möglich

Surface-mounted wall light, aluminium, internal circuit board for optimum glare control, 2700K or 3000K adjustable via dipswitch, through-wiring possible

## CADO MINI W



ART. NR./CODE	LEISTUNG/POWER	LUMEN	CRI>	KELVIN	L x B x H/L x W x H	FARBE/COLOUR	PREIS/PRICE
333-00052	SYS 4W	105/100	90	2700/3000	140 x 113 x 32	anthracite	149,00



## CADO W



ART. NR./CODE	LEISTUNG/POWER	LUMEN	CRI>	KELVIN	L x B x H/L x W x H	FARBE/COLOUR	PREIS/PRICE
333-00053	SYS 9W	195/200	90	2700/3000	250 x 113 x 32	anthracite	199,00

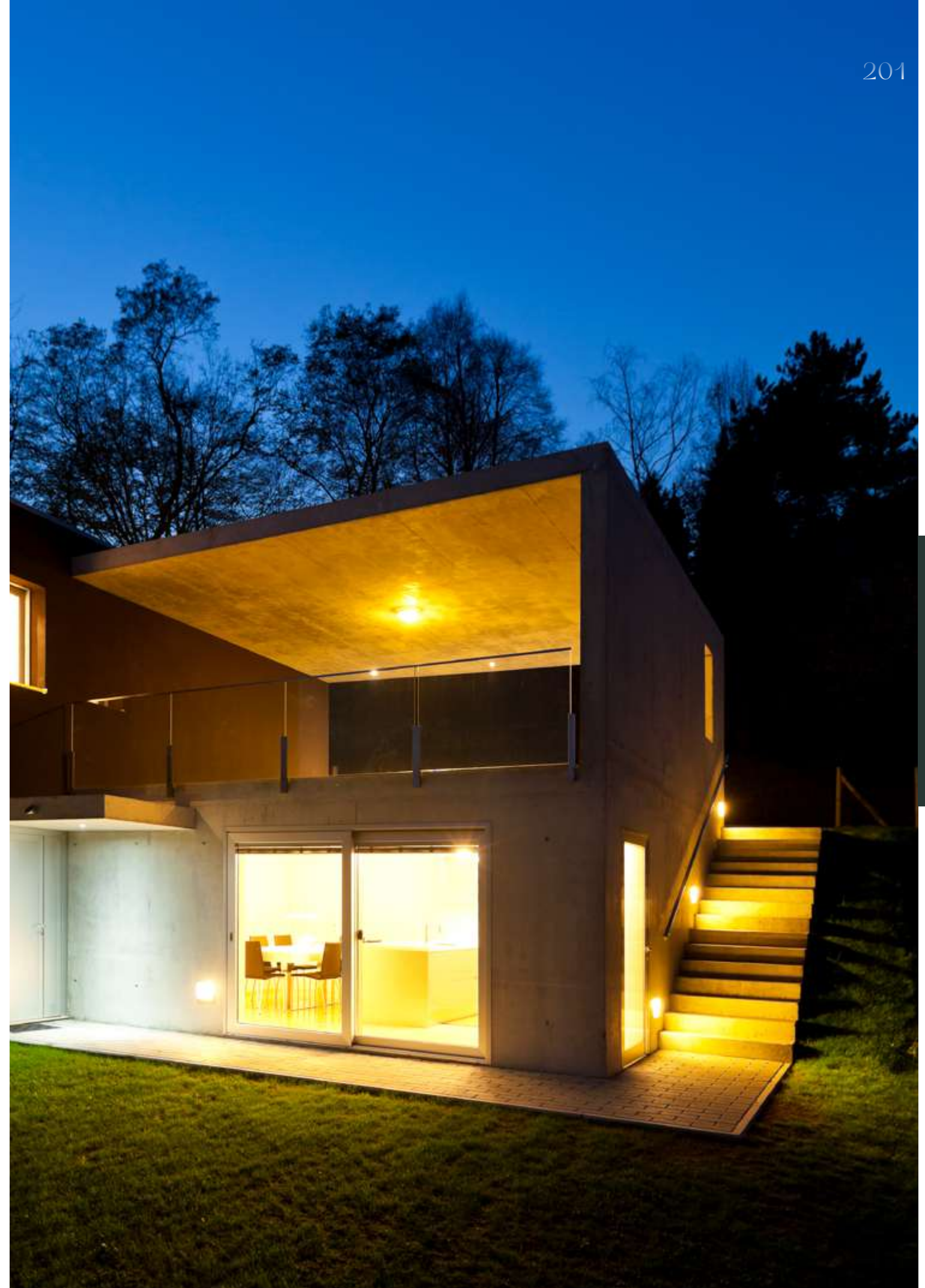



# POLLERLEUCHTEN BOLLARDS







Pollerleuchte, Aluminium, pulverbeschichtet, blendfrei, angenehme Lichtgleichmäßigkeit, breite Lichtverteilung von 10m, Durchgangsverdrahtung, inkl. Bodenplatte mit Betonanker, IP65, DALI2 dimmbar

Bollard luminaire, aluminium, powder-coated, glare-free, pleasant light uniformity, wide light distribution of 10m, through-wiring, incl. base plate with concrete anchor, IP65, DALI2 dimmable



**MONA MINI F**



ART. NR./CODE	LEISTUNG/POWER	LUMEN	CRI>	KELVIN	Ø x H/Ø x H	FARBE/COLOUR	PREIS/PRICE
333-00039	SYS 12W	550	80	3000	100 x 450	anthracite	369,00
333-00040	SYS 12W	550	80	3000	100 x 850	anthracite	399,00



**MONA F**



ART. NR./CODE	LEISTUNG/POWER	LUMEN	CRI>	KELVIN	Ø x H/Ø x H	FARBE/COLOUR	PREIS/PRICE
333-00034	SYS 23W	1060	80	3000	180 x 450	anthracite	539,00
333-00035	SYS 23W	1060	80	3000	180 x 850	anthracite	609,00

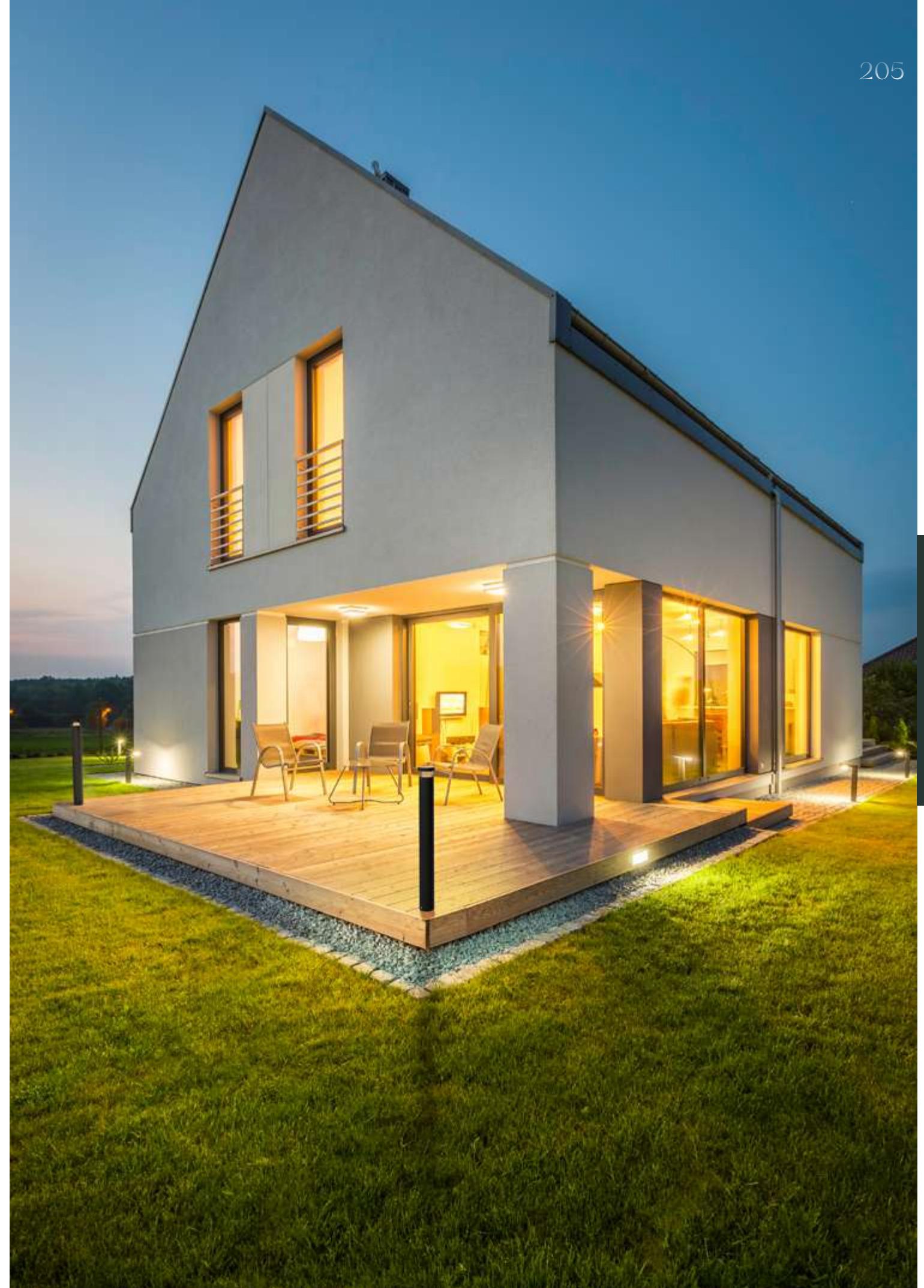





Pollerleuchte, Aluminiumdruckguss, Feinstruktur matt pulverbeschichtet, PC-Diffusor klar, 360° Ausstrahlwinkel, inkl. Konverter

Bollard luminaire, die-cast aluminium, matt powder-coated with fine textured paint, clear polycarbonate diffuser, 360° beam angle, incl. driver



**YARA ROUND F**



ART. NR./CODE	LEISTUNG/POWER	LUMEN	CRI>	KELVIN	Ø x H/Ø x H	FARBE/COLOUR	PREIS/PRICE
273-1000s	SYS 10W	685	80	3000	165 x 800	grey	359,00



**YARA SQUARE F**



ART. NR./CODE	LEISTUNG/POWER	LUMEN	CRI>	KELVIN	L x B x H/L x W x H	FARBE/COLOUR	PREIS/PRICE
273-1002s	SYS 10W	800	80	3000	150 x 150 x 800	grey	369,00

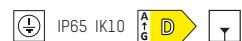

Pollerleuchte, Aluminiumdruckguss, Feinstruktur matt pulverbeschichtet, opaler Diffusor und Klarglasabdeckung, inkl. Konverter

Bollard luminaire, die-cast aluminium, matt powder-coated with fine textured paint, opal diffuser and transparent cover, incl. driver



**ZEON F**



ART. NR./CODE	LEISTUNG/POWER	LUMEN	CRI>	KELVIN	Ø x H/Ø x H	FARBE/COLOUR	PREIS/PRICE
472-0571390003006	SYS 12W	390	90	3000	120 x 900	black	489,00
472-0571390003011	SYS 12W	390	90	3000	120 x 900	anthracite	489,00







Pollerleuchte, Aluminiumdruckguss, Feinstruktur matt pulverbeschichtet, inkl. Konverter

Bollard luminaire, die-cast aluminium, matt powder-coated with fine textured paint, incl. driver



**BOOPER F**

ART. NR./CODE	LEISTUNG/POWER	LUMEN	CRI>	KELVIN	Ø x H	FARBE/COLOUR	PREIS/PRICE
472-90079500	SYS 9W	190	90	3000	80 x 600	white	299,00
472-90079900	SYS 9W	190	90	3000	80 x 600	anthracite	299,00



Pollerleuchte, Aluminiumdruckguss, Feinstruktur matt pulverbeschichtet, inkl. Konverter

Bollard luminaire, die-cast aluminium, matt powder-coated with fine textured paint, incl. driver



**ALIAR F**

ART. NR./CODE	LEISTUNG/POWER	LUMEN	CRI>	KELVIN	B x T x H/W x D x H	FARBE/COLOUR	PREIS/PRICE
472-90029600	SYS 12W	460	90	3000	80 x 150 x 600	black	289,00
472-90029900	SYS 12W	460	90	3000	80 x 150 x 600	anthracite	289,00

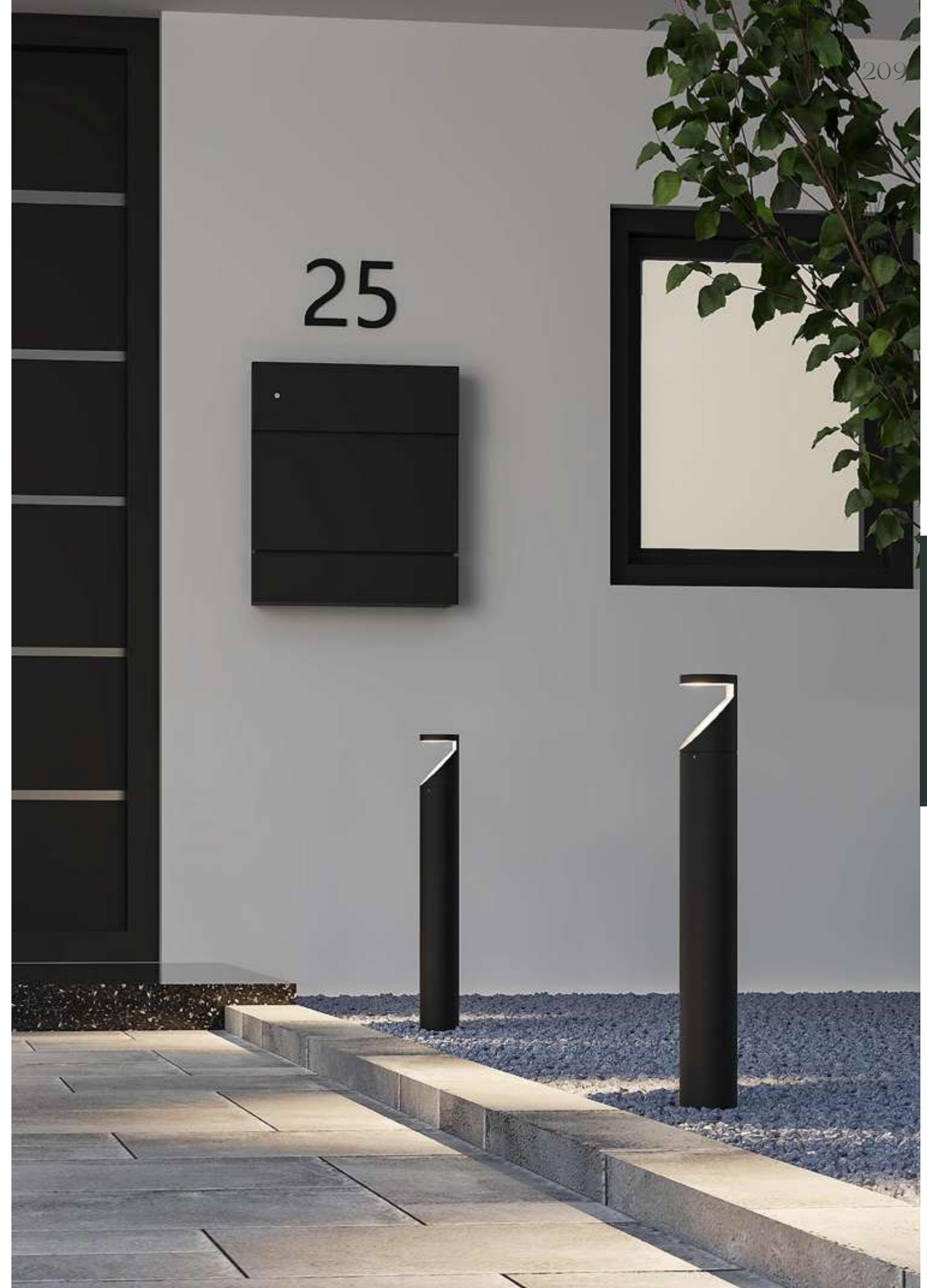
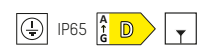





NEW

Pollerleuchte, Aluminium, pulverbeschichtet, Glas transparent oder milchig

Bollard light, aluminium, powder-coated, glass transparent or milky



## WILLIAM F

ART. NR./CODE	LM/BULB	FASSUNG/SOCKET	V AC	Ø x H/Ø x H	GLAS/GLASS	FARBE/COLOUR	PREIS/PRICE
333-00021	RETROFIT	E27	230	120 x 850	<input type="checkbox"/> clear	<input checked="" type="checkbox"/> anthracite	199,00
333-00024	RETROFIT	E27	230	120 x 850	<input type="checkbox"/> white	<input checked="" type="checkbox"/> anthracite	199,00



## LEUCHTMITTEL/LIGHT SOURCE

Weitere Leuchtmittel S./additional light sources P. 290

ART. NR./CODE	INFORMATION	PREIS/PRICE
30-380035	A60/CorePro LED Bulb clear, E27,7W, 827 Kelvin	4,90



Pollerleuchte, Aluminium, Feinstruktur pulverbeschichtet, Diffusor aus opalem Acryl, inkl. Konverter, AC-LED

Bollard luminaire, AC-LED, die-cast aluminium, matt powder-coated with fine textured paint, acrylic opal diffuser, incl. driver



## FYNN CP F

ART. NR./CODE	LEISTUNG/POWER	LUMEN	CRI>	KELVIN	L x B x H/L x W x H	FARBE/COLOUR	PREIS/PRICE
472-260057ag	SYS 10W	642	90	<input checked="" type="checkbox"/> 3000	100 x 100 x 900	<input checked="" type="checkbox"/> anthracite	399,00
472-260057s	SYS 10W	642	90	<input checked="" type="checkbox"/> 3000	100 x 100 x 900	<input checked="" type="checkbox"/> silver	399,00







BODENAUFBAULEUCHTEN  
GROUND MOUNTED LIGHTS





## CHOPA F

Erdspießleuchte, Aluminiumdruckguss, pulverbeschichtet, höhenverstellbar, inkl. Konverter und 1300mm Kabel mit Stecker

Ground spike luminaire, die-cast aluminium, powder coated, height adjustable, incl. converter and 1300mm cable with plug.



ART. NR./CODE	LEISTUNG/POWER	V AC	LUMEN	CRI>	KELVIN	Ø x B x H/Ø x W x H	FARBE/COLOUR	REFL.	PREIS/PRICE
472-90059600	SYS 7W	230	450	90	3000	60 x 132 x 400	black	38°	219,00



## HARK

Aufbaustrahler, Aluminiumdruckguss, pulverbeschichtet, Lichtaustritt direkt, Kabellänge 1320mm, inkl. Erdspieß, IP65, AC-LED,

Surface-mounted spotlight, die-cast aluminium, powder-coated, direct light emission, cable length 1320mm, incl. ground spike, IP65, AC LED,



ART. NR./CODE	LEISTUNG/POWER	V AC	LUMEN	CRI>	KELVIN	Ø x B x H/Ø x W x H	FARBE/COLOUR	REFL.	PREIS/PRICE
472-0250480403011	SYS 4W	230	255	80	3000	54 x 80 x 96	anthracite	36°	159,00



## FORIS F

Erdspießleuchte, Aluminium, neu mit CCT Chip, Ausstrahlwinkel 55° oder 35°, 2700K oder 3000K über DIP-Switch einstellbar

Ground spike luminaire, aluminium, new with CCT chip, beam angle 55° or 35°, 2700K or 3000K adjustable via dipswitch



ART. NR./CODE	LEISTUNG/POWER	V AC	LUMEN	CRI>	KELVIN	Ø x L	FARBE/COLOUR	REFL.	PREIS/PRICE
333-00033	SYS 11W	230	900/970	90	2700/3000	100 x 138	anthracite	60°	268,00

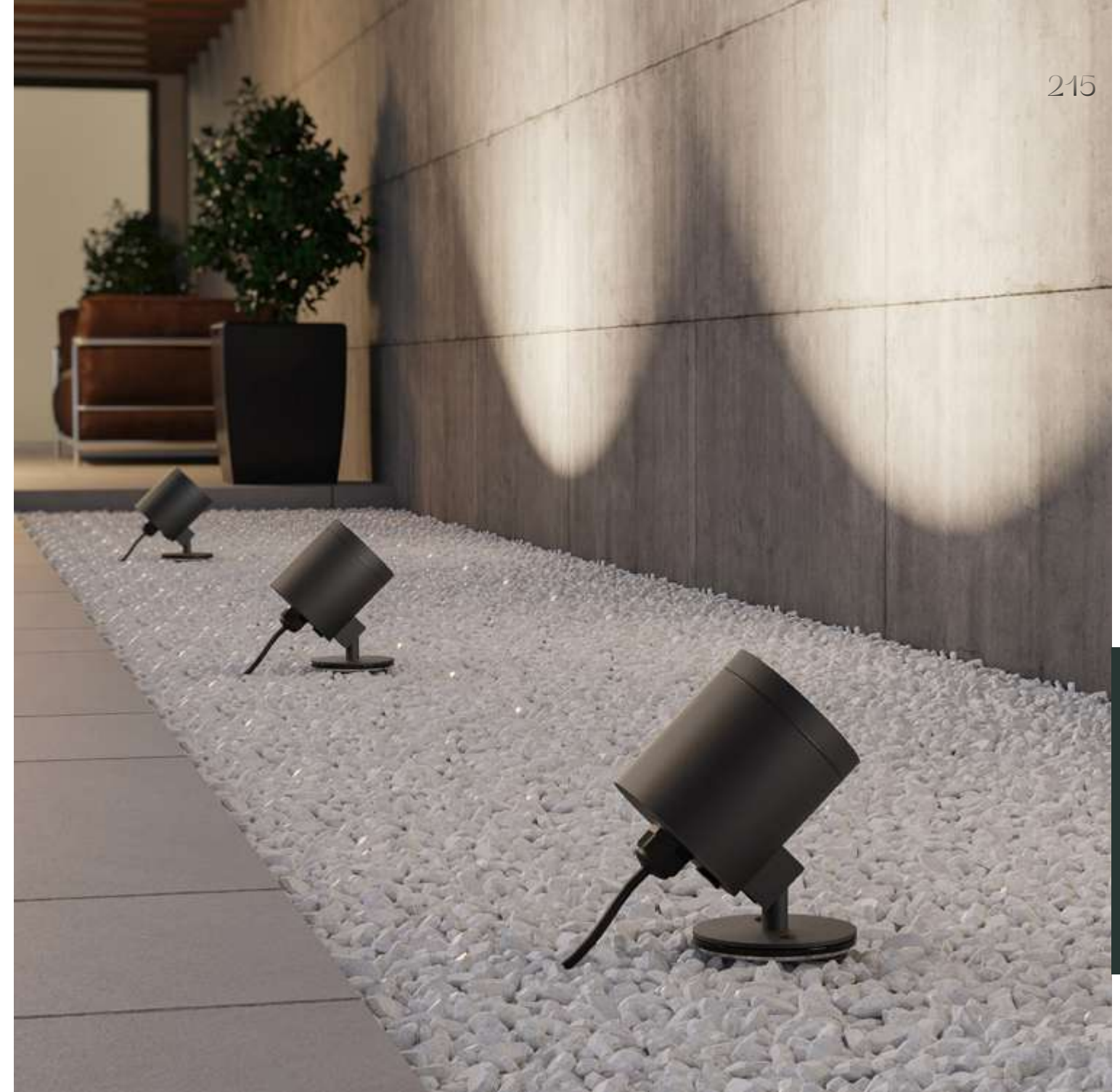

## REFLEKTOR/REFLECTOR

ART. NR./CODE	FARBE/COLOUR	REFL.	PREIS/PRICE
333-A00030	silver	35°	19,00
333-A00031	silver	55°	19,00



## ENDBLENDUNGSRING/SHUTTER RING

ART. NR./CODE	FARBE/COLOUR	PREIS/PRICE
341-7000	anthracite	49,00



## FORIS BEAM

ART. NR./CODE	FARBE/COLOUR	PREIS/PRICE
333-A00032	anthracite	15,00







Fluter, Aluminiumdruckguss, pulverbeschichtet, symmetrische COB-Optik, schwenkbar 90°, gehärtetes Schutzglas mit 4mm Dicke, IP66, inkl. Konverter

Floodlight, die-cast aluminium, powder-coated, symmetrical COB optics, swivelling 90°, tempered safety glass with 4mm thick, IP66, incl. converter



**MICRO RODIO SYMMETRISCH/MICRO RODIO SYMMETRIC**

ART. NR./CODE	LEISTUNG/POWER	LUMEN	CRI>	KELVIN	B x H x T/W x H x D	FARBE/COLOUR	PREIS/PRICE
125-41486039	SYS 29W	2309	90	3000	145 x 227 x 45	grey	141,90
125-41486239	SYS 29W	2309	90	3000	145 x 227 x 45	anthracite	141,90
125-41486000	SYS 29W	2483	90	4000	145 x 227 x 45	grey	141,90
125-41486200	SYS 29W	2483	90	4000	145 x 227 x 45	anthracite	141,90
125-41486539	SYS 38W	2811	90	3000	145 x 227 x 45	grey	133,40
125-41486739	SYS 38W	2811	90	3000	145 x 227 x 45	anthracite	133,40
125-41486500	SYS 38W	3023	90	4000	145 x 227 x 45	grey	133,40
125-41486700	SYS 38W	3023	90	4000	145 x 227 x 45	anthracite	133,40

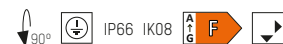

Fluter, Aluminiumdruckguss, pulverbeschichtet, symmetrische oder asymmetrische COB-Optik, gehärtetes Schutzglas mit 4mm Dicke, IP66, inkl. Konverter

Floodlight, die-cast aluminium, powder-coated aluminium, symmetrical or asymmetrical COB optics, tempered safety glass with 4mm thickness, IP66, incl. converter



**MICRO RODIO L SYMMETRISCH/MICRO RODIO L SYMMETRIC**

ART. NR./CODE	LEISTUNG/POWER	LUMEN	CRI>	KELVIN	B x H x T/W x H x D	FARBE/COLOUR	PREIS/PRICE
125-41489000	SYS 28W	3056	80	4000	145 x 227 x 45	grey	159,90

**MICRO RODIO L ASYMMETRISCH/MICRO RODIO L ASYMMETRIC**

ART. NR./CODE	LEISTUNG/POWER	LUMEN	CRI>	KELVIN	B x H x T/W x H x D	FARBE/COLOUR	PREIS/PRICE
125-41486739	SYS 28W	2811	80	4000	145 x 227 x 45	anthracite	133,40

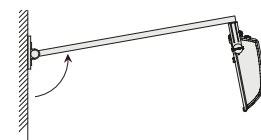

**WAND AUSLEGER/WALL BRACKET**

ART. NR./CODE	INFO	L/L	FARBE/COLOUR	PREIS/PRICE
125-99550600	Wandausleger, Stahl, schwenkbar/	800	grey	79,40
125-99550900	Wall bracket, steel, swivelling	800	anthracite	79,40



Fluter, Aluminiumdruckguss, pulverbeschichtet, symmetrische oder asymmetrische Linsen-Optik, gehärtetes Schutzglas mit 4mm Dicke, IP66, inkl. Konverter

Floodlight, die-cast aluminium, powder-coated, symmetrical or asymmetrical lens optics, tempered safety glass with 4mm thickness, IP66, incl. converter



**MINI RODIO SYMMETRISCH/MINI RODIO SYMMETRIC**

ART. NR./CODE	LEISTUNG/POWER	LUMEN	CRI>	KELVIN	B x H x T/W x H x D	FARBE/COLOUR	PREIS/PRICE
125-41494000	SYS 54W	8292	80	4000	273 x 400 x 70	grey	341,00
125-41494100	SYS 73W	10194	80	4000	273 x 400 x 70	grey	341,00

**MINI RODIO ASYMMETRISCH/MINI RODIO ASYMMETRIC**

ART. NR./CODE	LEISTUNG/POWER	LUMEN	CRI>	KELVIN	B x H x T/W x H x D	FARBE/COLOUR	PREIS/PRICE
125-41491000	SYS 54W	8456	80	4000	273 x 400 x 70	grey	341,00
125-41491100	SYS 73W	10396	80	4000	273 x 400 x 70	grey	341,00

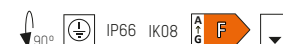

Fluter, Aluminiumdruckguss, pulverbeschichtet, symmetrische oder asymmetrische Linsen-Optik, gehärtetes Schutzglas, IP66, inkl. Konverter

Floodlight, die-cast aluminium, powder-coated, symmetrical or asymmetrical lens optics, tempered safety glass, IP66, incl. converter



**RODIO SYMMETRISCH LED/RODIO SYMMETRIC LED**

ART. NR./CODE	LEISTUNG/POWER	LUMEN	CRI>	KELVIN	B x H x T/W x H x D	FARBE/COLOUR	PREIS/PRICE
125-41478400	SYS 53W	8627	80	4000	333 x 568 x 85	grey	594,10
125-41478500	SYS 79W	11561	80	4000	333 x 568 x 85	grey	437,40
125-41478600	SYS 118W	16881	80	4000	333 x 568 x 85	grey	655,50
125-41478700	SYS 157W	21140	80	4000	333 x 568 x 85	grey	719,10

**RODIO ASYMMETRISCH LED/RODIO ASYMMETRIC LED**

ART. NR./CODE	LEISTUNG/POWER	LUMEN	CRI>	KELVIN	B x H x T/W x H x D	FARBE/COLOUR	PREIS/PRICE
125-41475400	SYS 53W	8799	80	4000	333 x 568 x 85	grey	594,10
125-41475500	SYS 79W	11789	80	4000	333 x 568 x 85	grey	437,40
125-41475600	SYS 118W	17213	80	4000	333 x 568 x 85	grey	655,50
125-41475700	SYS 157W	21559	80	4000	333 x 568 x 85	grey	719,10

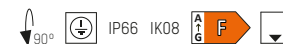

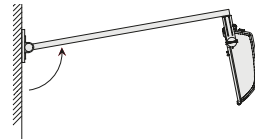

**WAND AUSLEGER/WALL BRACKET**

ART. NR./CODE	INFO	L/L	FARBE/COLOUR	PREIS/PRICE
125-99550400	Wandausleger, Stahl, schwenkbar/ wall bracket, steel, tilting	975	grey	186,40

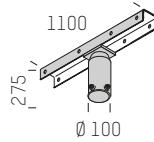
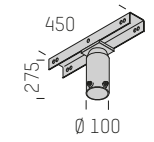
**MASTAUF SATZKONSOLE/POLE MOUNTING BRACKET**

ART. NR./CODE	INFO	Ø x L x H/Ø x L x H	FÜR/FOR	PREIS/PRICE
125-99790000	Mastaufsatzkonsole, verzinkt, für Mastzopf 60/76mm, Befestigung von 1-2 oder 2-4 Strahlern möglich, für Rodio, exkl. Fluter/ Pole mounting bracket, galvanized, for pole spigot 60/76mm, mounting of 1-2 or 2-4 spotlights possible, for Rodio, excl. floodlight	100 x 450 x 275	1 od. 2 Fluter/ 1 or 2 floodlights	210,70
125-99790100	Mastaufsatzkonsole, verzinkt, für Mastzopf 60/76mm, Befestigung von 1-2 oder 2-4 Strahlern möglich, für Rodio, exkl. Fluter/ Pole mounting bracket, galvanized, for pole spigot 60/76mm, mounting of 1-2 or 2-4 spotlights possible, for Rodio, excl. floodlight	100 x 1100 x 275	2 od. 4 Fluter/ 2 or 4 floodlights	295,50

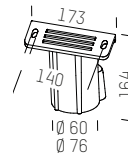
**MASTAUF SATZKONSOLE/POLE MOUNTING BRACKET**

ART. NR./CODE	INFO	Ø x L x H/Ø x L x H	FÜR/FOR	FARBE/COLOUR	PREIS/PRICE
125-99791500	Mastaufsatzkonsole, Aluminium, für Mastzopf DM= 60mm oder 76mm, für Litio, Indio und Rodio, exkl. Fluter/ Pole top bracket, aluminum, for pole spigot DM= 60mm or 76mm, for Litio, Indio and Rodio, excl. floodlight	60 x 173 x 164	1 FLUTER f. Mastzopf Ø 60/ 1 floodlight for pole spigot DM60	grey	59,30
125-99791600	Mastaufsatzkonsole, Aluminium, für Mastzopf DM= 60mm oder 76mm, für Litio, Indio und Rodio, exkl. Fluter/ Pole top bracket, aluminum, for pole spigot DM= 60mm or 76mm, for Litio, Indio and Rodio, excl. floodlight	76 x 173 x 164	1 FLUTER f. Mastzopf Ø 76/ 1 floodlight for pole spigot DM76	grey	56,10

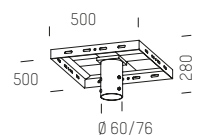
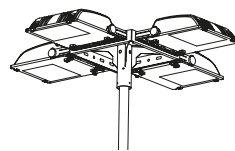
**MASTAUF SATZKONSOLE/POLE MOUNTING BRACKET**

ART. NR./CODE	INFO	Ø x L x H/Ø x L x H	FÜR/FOR	PREIS/PRICE
125-99809700	Mastaufsatzkonsole, verzinkt, für Mastzopf 60/76mm, Befestigung von 1-4 Strahlern möglich, für Rodio, exkl. Fluter/ Pole mounting bracket, galvanized, for pole spigot 60/76mm, mounting of 1-4 spotlights possible, for Rodio, excl. floodlight	500 x 500 x 280	1 - 4 Fluter für Mastzopf Ø 60/76/ 1-4 floodlights for pole spigot DM60/76	388,70

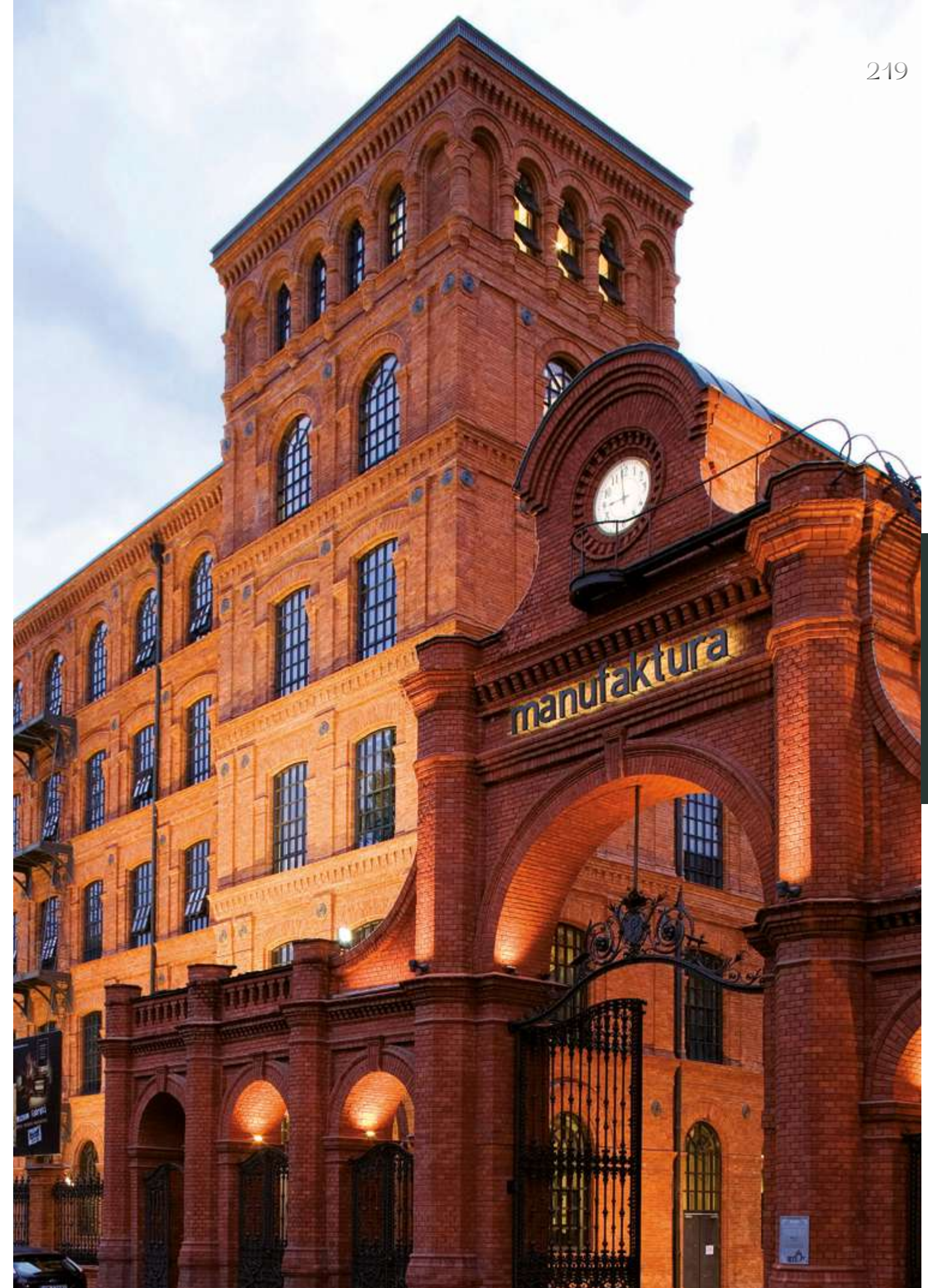





IP68

### PG KLEMMROHR/PG CLAMP TUBE



ART. NR./CODE	INFO	L x Ø	FARBE/COLOUR	PREIS/PRICE
102-thb391a3c	Klemmrohr mit PG Verschraubung für wasserdichte Kabelverbindungen, 3-poliger Block, Verwendung nur mit Kabel H05SS-F, für Kabel Ø 7-12 mm für max. 24A / 450V AC / Clamping tube with PG closure for waterproof cable connections, 3-pole block, only for use with cable H05SS-F, for cable diam. 7-12mm, for max. 24A/450V AC	66 x 23	■ black	11,60



IP68

### PG KLEMMROHR Y-FORM/PG CLAMP TUBE Y-FORM



ART. NR./CODE	INFO	L x B x Ø/L x W x Ø	FARBE/COLOUR	PREIS/PRICE
102-thb399a3c	Klemmrohr mit PG Verschraubung für wasserdichte Kabelverbindungen, 3-poliger Block, Verwendung nur mit Kabel H05SS-F, für Kabel Ø 7-12 mm für max. 24A / 450V AC / Clamping tube with PG closure for waterproof cable connections, 3-pole block, only for use with cable H05SS-F, for cable diam. 7-13,5mm, for max. 24A/450V AC	180 x 65,5 x 34	■ black	18,00

### H07 RN-F



### H07 RN8-F



#### Kabelverbindungen

Mithilfe der IP68 Klemmrohre lassen sich Kabeln mühelos und dauerhaft verbinden. Es ist keine zusätzliche Bohrung im Strahler für eine weitere Kabelverschraubung zulässig.

#### Cable connections

Cables can be connected effortlessly and permanently using the IP68 clamping tubes. No additional holes are required in the spotlight for an additional cable gland.



#### Betriebsgeräte

Einige Bodeneinbaustrahler bestehen durch ihre minimalistische Größe. Platzsparend und aus thermischen Gründen ist das Betriebsgerät hier nicht integriert. Im Innenbereich kann das Betriebsgerät einfach im Einbaugeschloß platziert werden. Achtung auf ausreichende Wärmeableitung. Im Außenbereich bietet ein Subverteiler oder Verteilerkasten sicheren Schutz vor Witterungseinflüssen.

#### Control gear

Some recessed floor spotlights are characterised by their minimalist size. To save space and for thermal reasons, the control gear is not integrated here. Indoors, the control gear can simply be placed in the recessed housing. Ensure adequate heat dissipation. Outdoors, a sub-distributor or distribution box provides reliable protection from the weather.



#### Reinigung der Dichtflächen

Um eine optimale Funktion und lange Lebensdauer zu gewährleisten, müssen die Dichtungen und Dichtflächen vor dem Einbau mit Alkohol oder einem geeigneten Lösungsmittel gereinigt werden. Anschließend wird ein dünner Film Vaseline aufgetragen. Achtung, jegliche Kontamination der Dichtflächen und Dichtungen mit Sand, Staub und Fasern oder anderen Partikeln nach der Reinigung und dem Einfetten sind zu vermeiden!

#### Cleaning the sealing surfaces

To ensure optimum function and a long service life, the seals and sealing surfaces must be cleaned with alcohol or a suitable solvent before installation. A thin film of Vaseline should then be applied. Attention, any contamination of the sealing surfaces and seals with sand, dust and fibres or other particles after cleaning and greasing must be avoided!

#### Befestigungsschrauben

Diese pressen Glas oder den Befestigungsring mit der Dichtung an die Dichtfläche. Es muss darauf geachtet werden, dass die Schrauben leichtgängig sind und ein unbeschädigtes Gewinde aufweisen.

Die Befestigungsschrauben sollten jeweils gegenüberliegend in 2-3 Durchgängen mit jeweils gesteigertem Drehmoment angezogen werden.

Eventuelle Angaben des Herstellers zum Drehmoment beachten! Sind keine expliziten Angaben vorhanden, die Schrauben gefühlvoll aber handfest anziehen um die mechanische Belastbarkeit zu gewährleisten und ein Zerspringen des Glases zu vermeiden.

#### Fixing screws

These press the glass or the fastening ring with the seal against the sealing surface. Care must be taken to ensure that the screws run smoothly and have an undamaged thread. The fastening screws should be tightened opposite each other in 2-3 passes, each with an increased torque.

Observe any torque specifications provided by the manufacturer! If there are no explicit specifications, tighten the screws sensitively but hand-tight to ensure the mechanical load-bearing capacity and to prevent the glass from cracking.

#### Leuchtmittel wechseln

Beim Austausch des Leuchtmittels ist es wichtig, nach dem Wechsel das Glas und die Dichtung gründlich zu reinigen. Beim Einsetzen der Dichtung Vaseline verwenden.

#### Changing the bulb

When replacing the bulb, it is important to clean the glass and seal thoroughly after replacement. Use Vaseline when inserting the seal.

#### Dichtungen

Gewährleisten eine optimale Abdichtung gegen Feuchtigkeit und Schmutz, daher sollten defekte oder alte Dichtungen sorgfältig gegen neue Original-Ersatzdichtungen, die einige Hersteller anbieten, ausgetauscht werden.

Silikonfugen sind für Bodeneinbaustrahler nicht geeignet und können zu Schäden führen.

#### Seals

Ensure optimum sealing against moisture and dirt, so defective or old seals should be carefully replaced with new original replacement seals, which some manufacturers offer. Silicone joints are not suitable for recessed floor spotlights and can lead to damage.



# TECNICO FLEX.light



TECNICO FLEX.light



Ab sofort sind unsere FLEX.light LEDs und Profile auch Online mit PC, Tablet oder Mobiltelefon konfigurierbar!

From now on, our FLEX.light LEDs and profiles can also be configured online with a PC, tablet or mobile phone!

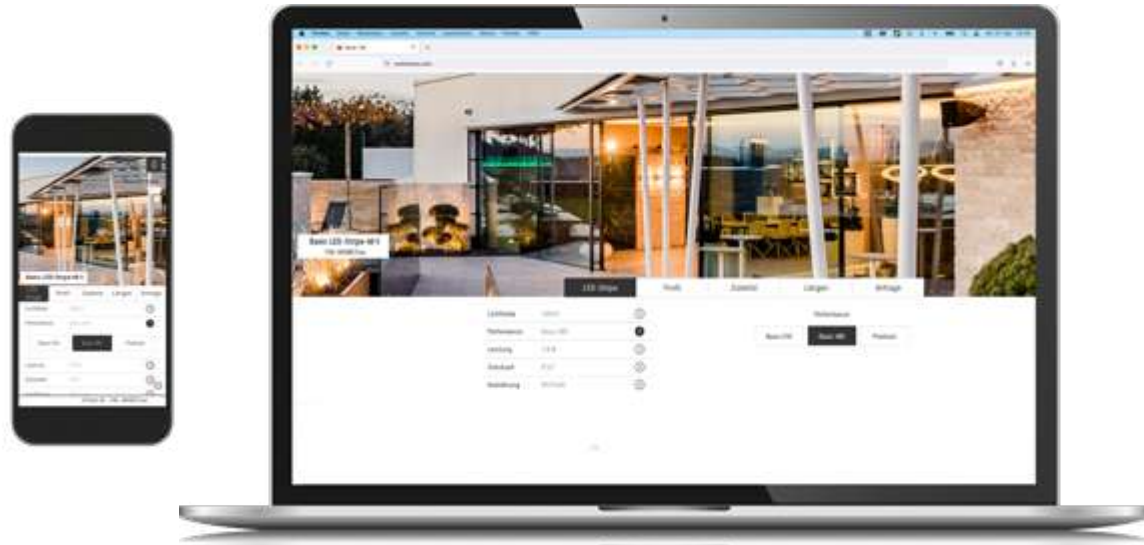

Unsere FLEX.light LEDs sind ab sofort rollenweise innerhalb von 24h versandbereit!  
Our FLEX.light LEDs are now ready to ship by the roll within 24h!



Jetzt einfach im Webshop bestellen:  
Order now in the webshop:





# PRODUKTÜBERSICHT TECNICO FLEX.light



NEW

**FLEX.light VANTI**  
Leistung/Power per M: 10W  
Lichtfarbe/Light colours: 2700, 3000 oder 4000K  
Info: S. 228/P. 228



NEW

**FLEX.light LATO**  
Leistung/Power per M: 10W  
Lichtfarbe/Light colours: 2700, 3000 oder 4000K  
Info: S. 230/P. 230



NEW

**FLEX.light COLLINA**  
Leistung/Power per M: 10W  
Lichtfarbe/Light colours: 2700, 3000 oder 4000K  
Info: S. 233/P. 233



**FLEX.light PREMIUM 5W**  
Leistung/Power per M: 5W  
Lichtfarbe/Light colours: 2500, 2700, 3000 oder 4000K  
Info: S. 234/P. 234



**FLEX.light PREMIUM 9W**  
Leistung/Power per M: 9W  
Lichtfarbe/Light colours: 2500, 2700, 3000 oder 4000K  
Info: S. 235/P. 235

**FLEX.light PREMIUM 18W**  
Leistung/Power per M: 18W  
Lichtfarbe/Light colours: 2500, 2700, 3000 oder 4000K  
Info: S. 235/P. 235

**FLEX.light PREMIUM 28W**  
Leistung/Power per M: 28W  
Lichtfarbe/Light colours: 2500, 2700, 3000 oder 4000K  
Info: S. 235/P. 235



**FLEX.light BASIC 4,8W**  
Leistung/Power per M: 4,8W  
Lichtfarbe/Light colours: 2700, 3000 oder 4000K  
Info: S. 238/P. 238



**FLEX.light BASIC 9,6W**  
Leistung/Power per M: 9,6W  
Lichtfarbe/Light colours: 2700, 3000 oder 4000K  
Info: S. 238/P. 238



**FLEX.light BASIC 14,4W**  
Leistung/Power per M: 14,4W  
Lichtfarbe/Light colours: 2700, 3000 oder 4000K  
Info: S. 240/P. 240



**FLEX.light DIM2WARM 14,4W**  
Leistung/Power per M: 14,4W  
Lichtfarbe/Light colours: 2200, 2700 oder 3000K  
Info: S. 242/P. 242



**FLEX.light TUNABLE WHITE 14,4W**  
Leistung/Power per M: 14,4W  
Lichtfarbe/Light colours: 2700 oder 6500K  
Info: S. 242/P. 242



**FLEX.light RGBW 18,1W**  
Leistung/Power per M: 18,1W  
Lichtfarbe/Light colours: RGB + 3000K  
Info: S. 244/P. 244

# INDEX TECNICO FLEX.light



**FLEX.light 4,8W**  
Leistung/Power per M: 4,8W  
Lichtfarbe/Light colours: 3000 oder 4000K  
Info: S. 246/P. 246



**FLEX.light 14,4W**  
Leistung/Power per M: 14,4W  
Lichtfarbe/Light colours: 3000 oder 4000K  
Info: S. 246/P. 246



**FLEX.light TUNABLE WHITE 14,4W**  
Leistung/Power per M: 14,4W  
Lichtfarbe/Light colours: 2700 oder 6500K  
Info: S. 247/P. 247



**FLEX.light RGBW 18,1W**  
Leistung/Power per M: 18,1W  
Lichtfarbe/Light colours: RGB + 3000K  
Info: S. 248/P. 248



**FLEX.light BASIC 48V IP67 4,8W**  
Leistung/Power per M: 4,8W  
Lichtfarbe/Light colours: 3000 oder 4000K  
Info: S. 250/P. 250



## PROFILE & ZUBEHÖR/PROFILES & ACCESSOIRES

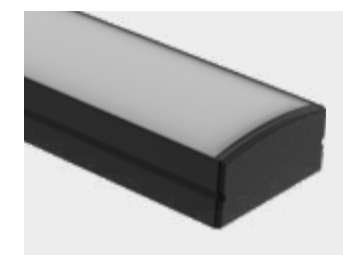

**PROFILE/PROFILES**  
Info: S. 252/P. 252



**KONVERTER/CONVERTER**  
Info: S. 268/P.268

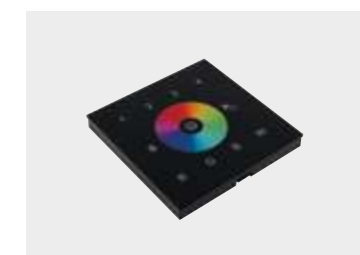

**KONTROLLER/CONTROLLER**  
Info: S. 272/P. 272



FLEX.light VANTI, IP67, punktfreie, homogene Ausleuchtung, 3step macadam binning, CRI 90 80lm/W, Topview, vertikales Biegen möglich, passendes Zubehör, Profile, Flexprofile etc., multifunktional einsetzbar, Ausstrahlwinkel 113°

LIGHT VANTI, IP67, point-free, homogeneous illumination, 3step macadam binning, CRI 90 80lm/W, Topview, vertical bending possible, matching accessories, profiles, flex profiles etc., multifunctional use, beam angle 113°

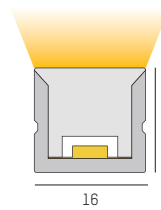
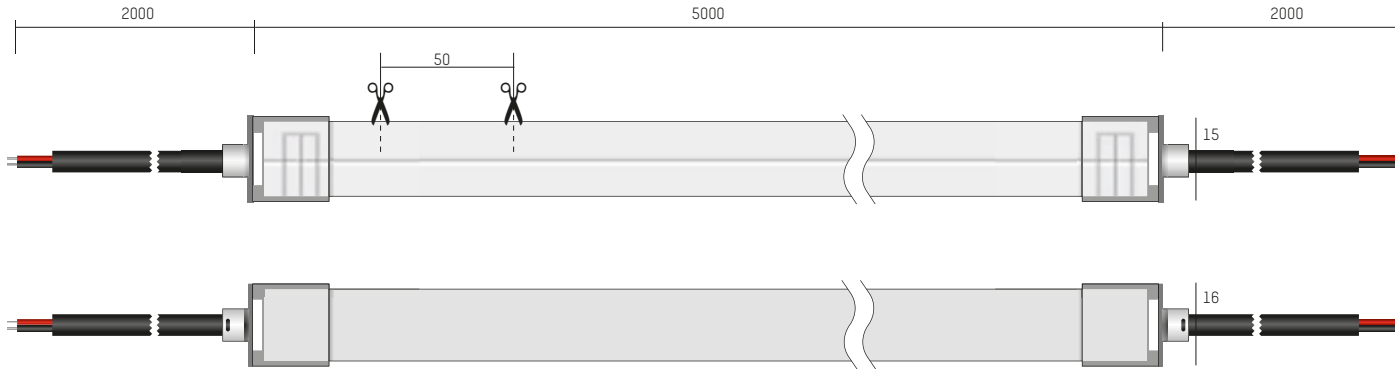

**FLEX.light VANTI** ACHTUNG: maximale Länge pro Einspeisepunkt 13m LED/ Attention: Maximum length per feed point 13m

ART. NR./CODE	WATT LFM/WATT PER METRE	V DC	LM/M	CRI>	KELVIN	L x B x H/L x W x H	VE/PACKAGE	PREIS/PRICE
444-00001	LED 10W/m	24	780	90	2700	13000 x 16 x 15	Rolle/Roll	1287,00
444-00002	LED 10W/m	24	810	90	3000	13000 x 16 x 15	Rolle/Roll	1287,00
444-00003	LED 10W/m	24	910	90	4000	13000 x 16 x 15	Rolle/Roll	1287,00
444-00001konf	LED 10W/m	24	780	90	2700	1000 x 16 x 15	per Meter/per Metre	99,00
444-00002konf	LED 10W/m	24	810	90	3000	1000 x 16 x 15	per Meter/per Metre	99,00
444-00003konf	LED 10W/m	24	910	90	4000	1000 x 16 x 15	per Meter/per Metre	99,00



**KONFEKTIONIERUNG FLEX.light VANTI IP67/ASSEMBLY FLEX.light VANTI IP67**

ART. NR./CODE	INFORMATION	PREIS/PRICE
283-konf	LED Band IP67 pro Zuschnitt beinhaltet: Zuschnitt, 50cm Anschlusskabel gelötet, Systemtest, ESD-Verpackung cut to size, 50cm soldered connection cable, cut seal, system test, ESD packing	21,60



**PROFIL/PROFILE**

ART. NR./CODE	L x B x H/L x W x H	PREIS/PRICE
444-00004	2000 x 20 x 18	24,00

**MONTAGECLIP SET/MOUNTING CLIP**

ART. NR./CODE	L x B x H/L x W x H	PREIS/PRICE
444-00006	20 x 17 x 13	19,00

**EINSPEISUNG/POWER FEED**

ART. NR./CODE	L x B x H/L x W x H	PREIS/PRICE
444-00008	28 x 21 x 20	9,00

**ENDKAPPE/END CAP**

ART. NR./CODE	L x B x H/L x W x H	PREIS/PRICE
444-00010	28 x 21 x 20	7,00

**EINSPEISUNG/POWER FEED**

ART. NR./CODE	L x B x H/L x W x H	PREIS/PRICE
444-00038	28 x 21 x 20	9,00

**FLEXRAIL/FLEXRAIL**

ART. NR./CODE	L x B x H/L x W x H	PREIS/PRICE
444-00005	500 x 17 x 15	19,00

**EINSPEISUNG/POWER FEED**

ART. NR./CODE	L x B x H/L x W x H	PREIS/PRICE
444-00007	28 x 21 x 20	9,00

**EINSPEISUNG/POWER FEED**

ART. NR./CODE	L x B x H/L x W x H	PREIS/PRICE
444-00009	28 x 21 x 20	9,00

**EINSPEISUNG/POWER FEED**

ART. NR./CODE	L x B x H/L x W x H	PREIS/PRICE
444-00036	28 x 21 x 20	9,00

**EINSPEISUNG/POWER FEED**

ART. NR./CODE	L x B x H/L x W x H	PREIS/PRICE
444-00040	28 x 21 x 20	9,00





FLEX.light LATO, IP67, 3step macadam binning, CRI 90 60lm/W, Sideview-seitliches / horizontales Biegen möglich, passendes Zubehör Profile, Flexprofile etc., multifunktional einsetzbar, Ausstrahlwinkel 114°

FLEX.light LATO, IP67, 3step macadam binning, CRI 90 60lm/W, side view / horizontal bending possible, suitable accessories profiles, flex profiles etc., multifunctional use, beam angle 114°

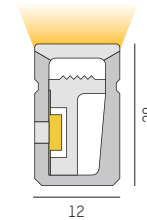
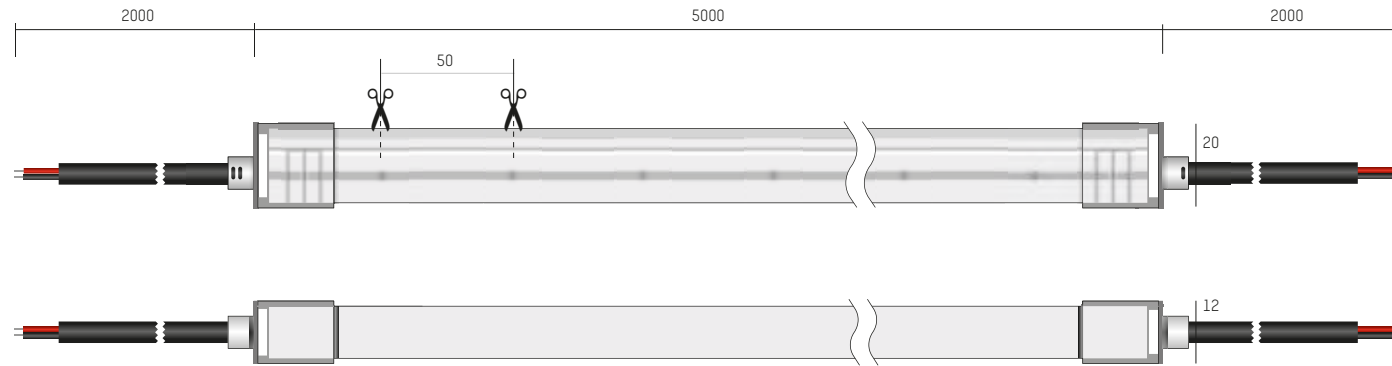

**FLEX.light LATO** ACHTUNG: maximale Länge pro Einspeisepunkt 13m LED/ Attention: Maximum length per feed point 13m

ART. NR./CODE	WATT LFM/WATT PER METRE	V DC	LM/M	CRI>	KELVIN	L x B x H/L x W x H	VE/PACKAGE	PREIS/PRICE
444-00011	LED 10W/m	24	570	90	2700	13000 x 12 x 20	Rolle/Roll	1287,00
444-00012	LED 10W/m	24	580	90	3000	13000 x 12 x 20	Rolle/Roll	1287,00
444-00013	LED 10W/m	24	630	90	4000	13000 x 12 x 20	Rolle/Roll	1287,00
444-00011konf	LED 10W/m	24	570	90	2700	1000 x 12 x 20	per Meter/per Metre	99,00
444-00012konf	LED 10W/m	24	580	90	3000	1000 x 12 x 20	per Meter/per Metre	99,00
444-00013konf	LED 10W/m	24	630	90	4000	1000 x 12 x 20	per Meter/per Metre	99,00



**KONFEKTIONIERUNG FLEX.light LATO IP67/ASSEMBLY FLEX.light LATO IP67**

ART. NR./CODE	INFORMATION	PREIS/PRICE
283-konf	LED Band IP67 pro Zuschnitt beinhaltet: Zuschnitt, 50cm Anschlusskabel gelötet, Systemtest, ESD-Verpackung cut to size, 50cm soldered connection cable, cut seal, system test, ESD packing	21,60

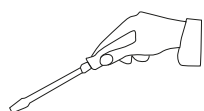

**PROFIL/PROFILE**

ART. NR./CODE	L x B x H/L x W x H	PREIS/PRICE
444-00014	2000 x 18 x 23	24,00

**MONTAGECLIP SET/MOUNTING CLIP**

ART. NR./CODE	L x B x H/L x W x H	PREIS/PRICE
444-00016	20 x 13 x 19	19,00

**EINSPEISUNG/POWER FEED**

links/left

ART. NR./CODE	L x B x H/L x W x H	PREIS/PRICE
444-00018	27 x 17 x 25	9,00

**ENDKAPPE/END CAP**

2 Stk./2 Pcs.

ART. NR./CODE	L x B x H/L x W x H	PREIS/PRICE
444-00020	27 x 17 x 25	7,00

**EINSPEISUNG/POWER FEED**

vorne/rechts

ART. NR./CODE	L x B x H/L x W x H	PREIS/PRICE
444-00041	27 x 17 x 25	9,00

**FLEXRAIL/FLEXRAIL**

ART. NR./CODE	L x B x H/L x W x H	PREIS/PRICE
444-00015	500 x 27 x 18	19,00

**EINSPEISUNG/POWER FEED**

vorne/links/front/left

ART. NR./CODE	L x B x H/L x W x H	PREIS/PRICE
444-00017	28 x 21 x 20	9,00

**EINSPEISUNG/POWER FEED**

unten/links/bottom/left

ART. NR./CODE	L x B x H/L x W x H	PREIS/PRICE
444-00019	27 x 17 x 25	9,00

**EINSPEISUNG/POWER FEED**

rechts/right

ART. NR./CODE	L x B x H/L x W x H	PREIS/PRICE
444-00037	27 x 17 x 25	9,00

**EINSPEISUNG/POWER FEED**

unten/rechts/bottom/right

ART. NR./CODE	L x B x H/L x W x H	PREIS/PRICE
444-00041	27 x 17 x 25	9,00





FLEX.light COLLINA, IP65, punktfreie, homogene Ausleuchtung, sehr flach und elegant, UV und Korrosionsbeständig, 3step macadam binning, CRI 90, Ausstrahlwinkel 130°

FLEX.light COLLINA, IP65, point-free, homogeneous illumination, very flat and elegant, UV and corrosion-resistant, 3step macadam binning, CRI90, beam angle 130°

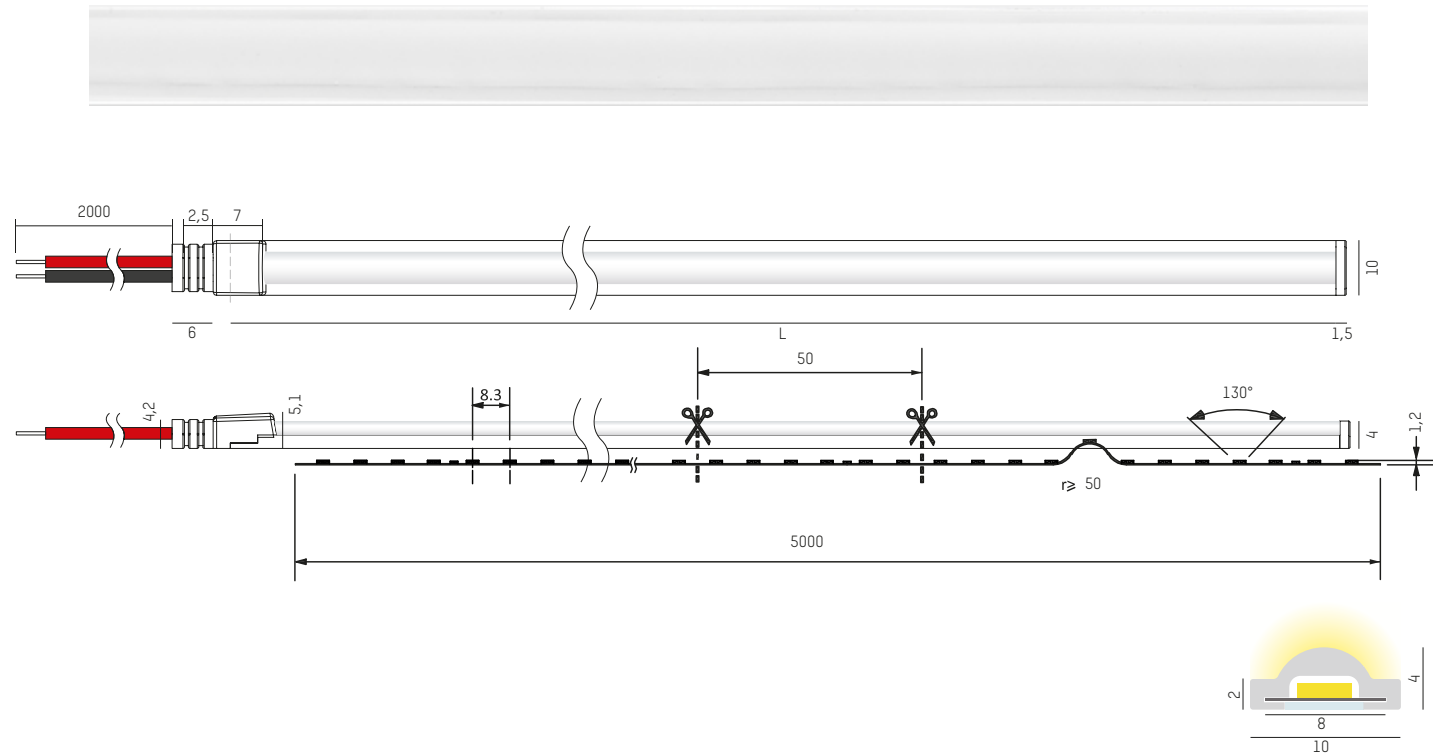

**FLEX.light COLLINA**

ACHTUNG: maximale Länge pro Einspeisepunkt 5m LED/ Attention: Maximum length per feed point 5m

ART. NR./CODE	WATT LFM/WATT PER METRE	V DC	LM/M	CRI>	KELVIN	L x B x H/L x W x H	VE/PACKAGE	PREIS/PRICE
444-00030	LED 10W/m	24	760	90	2700	5000 x 10 x 4	Rolle/Roll	195,00
444-00031	LED 10W/m	24	790	90	3000	5000 x 10 x 4	Rolle/Roll	195,00
444-00032	LED 10W/m	24	840	90	4000	5000 x 10 x 4	Rolle/Roll	195,00
444-00030konf	LED 10W/m	24	760	90	2700	1000 x 10 x 4	per Meter/per Metre	39,00
444-00031konf	LED 10W/m	24	790	90	3000	1000 x 10 x 4	per Meter/per Metre	39,00
444-00032konf	LED 10W/m	24	840	90	4000	1000 x 10 x 4	per Meter/per Metre	39,00



**MONTAGECLIP/MOUNTING CLIP**  
weiss/white

ART. NR./CODE	L x B x H/L x W x H	PREIS/PRICE
444-00033	14 x 12 x 5	3,00

**ENDKAPPE MIT EINSPEISUNG/ ENDPIECE WITH POWERFEED**  
mit 20cm Kabel, weiss/with 20cm cable, white

ART. NR./CODE	L x B x H/L x W x H	PREIS/PRICE
444-00034	12 x 6 x 16	3,00

**ENDKAPPE/ENDPIECE**

ART. NR./CODE	L x B x H/L x W x H	PREIS/PRICE
444-00035	12 x 6 x 9	2,00

**KONFEKTIONIERUNG FLEX.light COLLINA IP67/ASSEMBLY FLEX.light COLLINA IP67**

ART. NR./CODE	INFORMATION	PREIS/PRICE
283-konf	LED Band IP67 pro Zuschnitt beinhaltet: Zuschnitt, 50cm Anschlusskabel gelötet, Systemtest, ESD-Verpackung cut to size, 50cm soldered connection cable, cut seal, system test, ESD packing	21,60

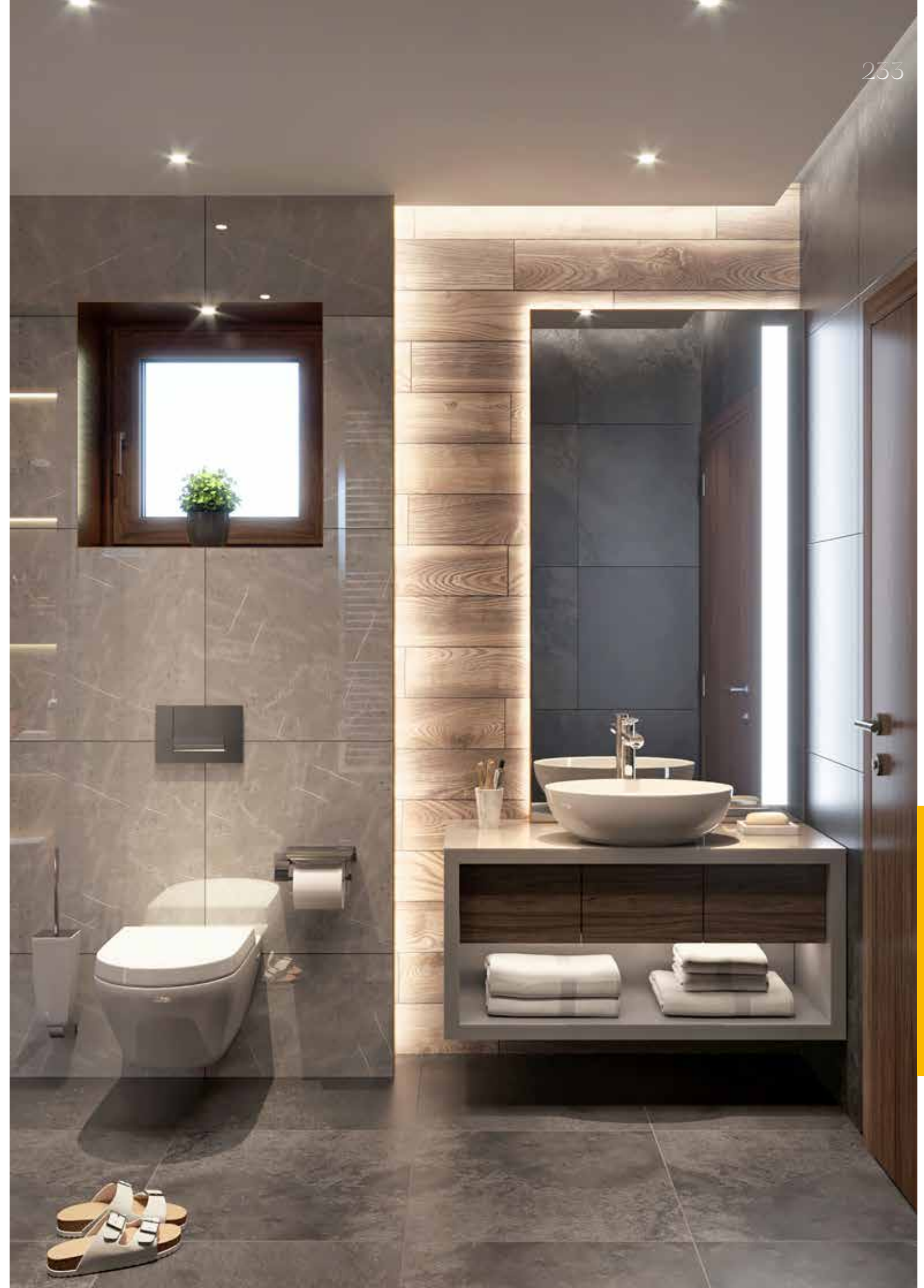



Flexibles PREMIUM LED Stripe, IP65 mittels Plasmabeschichtung, Meterware, 120 LEDs/M, 5W/M, 3step macadam binning, trennbar alle 5cm, Befestigung durch doppelseitiges 3M Klebeband, exkl. Konverter, Montage auf wärmeleitendem Material Voraussetzung! Bitte kalkulieren Sie pro Zuschnitt 1x Art.-Nr.: 283-konf zusätzlich

Flexible PREMIUM LED stripe, IP65, by plasma coating, 120 LEDs/m, separable each 5 cm, fixing with double-sided adhesive tape 3M, without driver, in order to guarantee a long service life and perfect functioning of the LED stripes, they must be mounted on heat conducting material! Please calculate per cut 1x code 283-konf additionally.

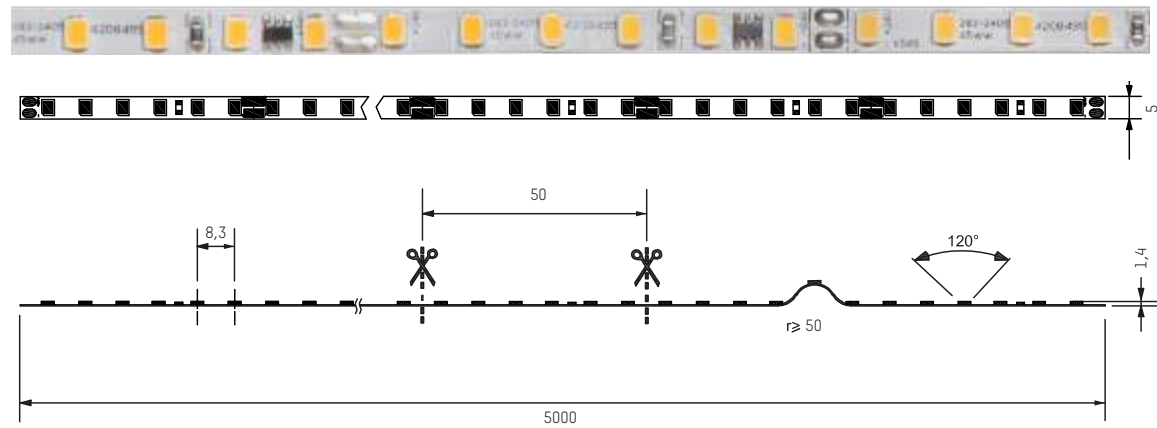

**FLEX.light PREMIUM 5W** ACHTUNG: maximale Länge pro Einspeisepunkt 5m LED/ Attention: Maximum length per feed point 5m

ART. NR./CODE	LEISTUNG/POWER	V DC	LM/M	CRI>	KELVIN	L x B x H/L x W x H	VE/PACKAGE	PREIS/PRICE
283-240565uuww	LED 5W/m	24	440	90	2500	10000 x 5 x 1,4	Rolle/Roll	484,00
283-240565uwvw	LED 5W/m	24	470	90	2700	10000 x 5 x 1,4	Rolle/Roll	484,00
283-240565swww	LED 5W/m	24	520	90	3000	10000 x 5 x 1,4	Rolle/Roll	484,00
283-240565nwnw	LED 5W/m	24	580	90	4000	10000 x 5 x 1,4	Rolle/Roll	484,00
283-240565uuwwkonf	LED 5W/m	24	440	90	2500	lt. order x 5 x 1,4	per Meter/per Metre	48,70
283-240565uwvwkonf	LED 5W/m	24	470	90	2700	lt. order x 5 x 1,4	per Meter/per Metre	48,70
283-240565swwwkonf	LED 5W/m	24	520	90	3000	lt. order x 5 x 1,4	per Meter/per Metre	48,70
283-240565nwnwkonf	LED 5W/m	24	580	90	4000	lt. order x 5 x 1,4	per Meter/per Metre	48,70

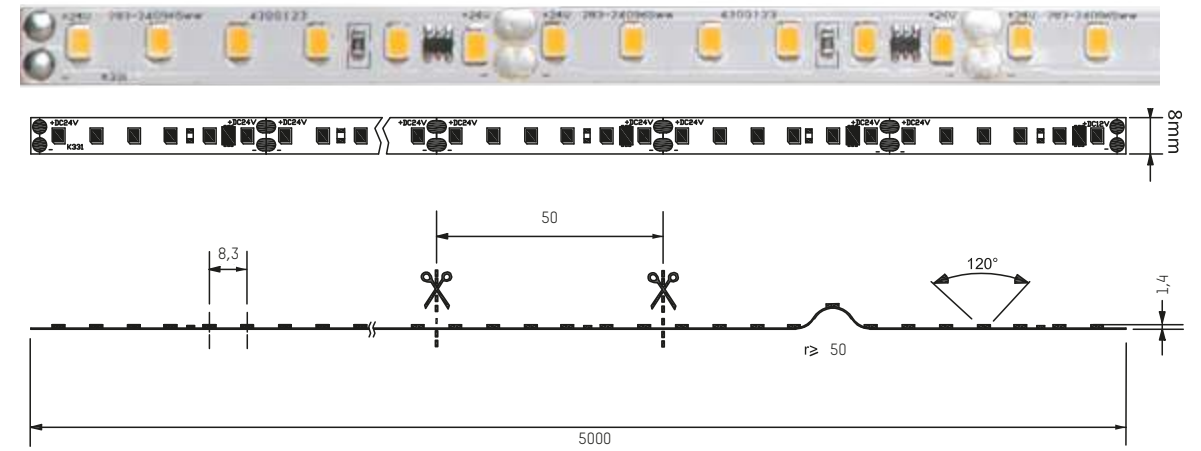

**FLEX.light PREMIUM 9W** ACHTUNG: maximale Länge pro Einspeisepunkt 10m LED/ Attention: Maximum length per feed point 10m

ART. NR./CODE	LEISTUNG/POWER	V DC	LM/M	CRI>	KELVIN	L x B x H/L x W x H	VE/PACKAGE	PREIS/PRICE
283-240965uuww	LED 9W/m	24	950	90	2500	30000 x 8 x 1,4	Rolle/Roll	1522,80
283-240965uwvw	LED 9W/m	24	1054	90	2700	30000 x 8 x 1,4	Rolle/Roll	1522,80
283-240965swww	LED 9W/m	24	1058	90	3000	30000 x 8 x 1,4	Rolle/Roll	1522,80
283-240965nwnw	LED 9W/m	24	1134	90	4000	30000 x 8 x 1,4	Rolle/Roll	1522,80
283-240965uuwwkonf	LED 9W/m	24	950	90	2500	lt. order x 8 x 1,4	per Meter/per Metre	50,80
283-240965uwvwkonf	LED 9W/m	24	1054	90	2700	lt. order x 8 x 1,4	per Meter/per Metre	50,80
283-240965swwwkonf	LED 9W/m	24	1058	90	3000	lt. order x 8 x 1,4	per Meter/per Metre	50,80
283-240965nwnwkonf	LED 9W/m	24	1134	90	4000	lt. order x 8 x 1,4	per Meter/per Metre	50,80

**FLEX.light PREMIUM 18W** ACHTUNG: maximale Länge pro Einspeisepunkt 8m LED/ Attention: Maximum length per feed point 8m

ART. NR./CODE	LEISTUNG/POWER	V DC	LM/M	CRI>	KELVIN	L x B x H/L x W x H	VE/PACKAGE	PREIS/PRICE
283-241865uuww	LED 18W/m	24	1755	90	2500	30000 x 8 x 1,4	Rolle/Roll	1588,50
283-241865uwvw	LED 18W/m	24	1934	90	2700	30000 x 8 x 1,4	Rolle/Roll	1588,50
283-241865swww	LED 18W/m	24	1980	90	3000	30000 x 8 x 1,4	Rolle/Roll	1588,50
283-241865nwnw	LED 18W/m	24	2148	90	4000	30000 x 8 x 1,4	Rolle/Roll	1588,50
283-241865uuwwkonf	LED 18W/m	24	1755	90	2500	lt. order x 8 x 1,4	per Meter/per Metre	53,00
283-241865uwvwkonf	LED 18W/m	24	1934	90	2700	lt. order x 8 x 1,4	per Meter/per Metre	53,00
283-241865swwwkonf	LED 18W/m	24	1980	90	3000	lt. order x 8 x 1,4	per Meter/per Metre	53,00
283-241865nwnwkonf	LED 18W/m	24	2148	90	4000	lt. order x 8 x 1,4	per Meter/per Metre	53,00

**FLEX.light PREMIUM 28W** ACHTUNG: maximale Länge pro Einspeisepunkt 4m LED/ Attention: Maximum length per feed point 4m

ART. NR./CODE	LEISTUNG/POWER	V DC	LM/M	CRI>	KELVIN	L x B x H/L x W x H	VE/PACKAGE	PREIS/PRICE
283-242865uuww	LED 28W/m	24	2500	90	2500	30000 x 8 x 1,4	Rolle/Roll	1729,30
283-242865uwvw	LED 28W/m	24	2890	90	2700	30000 x 8 x 1,4	Rolle/Roll	1729,30
283-242865swww	LED 28W/m	24	2922	90	3000	30000 x 8 x 1,4	Rolle/Roll	1729,30
283-242865nwnw	LED 28W/m	24	3191	90	4000	30000 x 8 x 1,4	Rolle/Roll	1729,30
283-242865uuwwkonf	LED 28W/m	24	2500	90	2500	lt. order x 8 x 1,4	per Meter/per Metre	57,20
283-242865uwvwkonf	LED 28W/m	24	2890	90	2700	lt. order x 8 x 1,4	per Meter/per Metre	57,20
283-242865swwwkonf	LED 28W/m	24	2922	90	3000	lt. order x 8 x 1,4	per Meter/per Metre	57,20
283-242865nwnwkonf	LED 28W/m	24	3191	90	4000	lt. order x 8 x 1,4	per Meter/per Metre	57,20



**KONFEKTIONIERUNG FLEX.light PREMIUM/ASSEMBLY FLEX.light PREMIUM**

ART. NR./CODE	INFO	PREIS/PRICE
283-konf	LED Band IP65 pro Zuschnitt beinhaltet: Zuschnitt, 50cm Anschlusskabel gelötet, Anschnittversiegelung, Systemtest, ESD-Verpackung/ cut to size, 50cm soldered connection cable, cut seal, system test, ESD packing	21,60

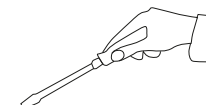







Flexibles BASIC LED Stripe, Rolle 5000mm, 300 SMD3528 LEDs, 60 LEDs/M, 4,8, 9,6 und 14,4W/M 3step macadam binning, trennbar alle 6 LEDs (ca. 10cm), Befestigung durch doppel-seitiges 3M Klebeband, exkl. Konverter.

**ACHTUNG:** Keine Beständigkeit gegen chemische Substanzen oder Dämpfe (z.B. Chlor u. dgl.); Um eine lange Lebensdauer und einwandfreie Funktion der LED-Stripes zu garantieren, ist eine Montage auf wärmeleitendem Material Voraussetzung! Bitte kalkulieren Sie pro Zuschnitt 1 x Art.-Nr.: 746-konf zusätzlich

Flexible BASIC LED stripe, roll 5000mm, 300 SMD3528 LEDs, 60 LEDs/m, 4,8, 9,6 and 14,4W/m, separable each 6 LEDs (ca. 10cm), fixing with double-sided adhesive tape 3M, without driver, please calculate per cut 1x code: 746-konf additionally.

**Attention:** No resistance to chemical substances or vapours (e.g. chlorine and similar). In order to guarantee a long service life and perfect functioning of the LED stripes, they must be mounted on heat conducting material!

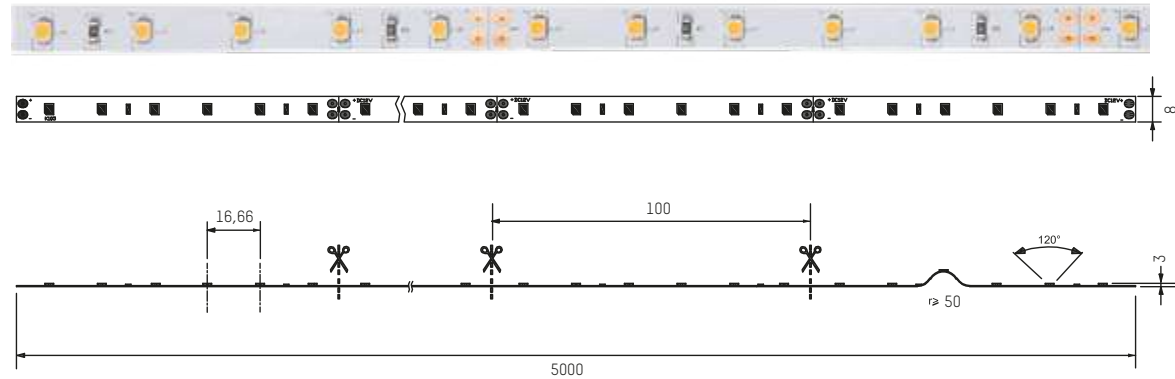

**FLEX.light BASIC 4,8W**

**ACHTUNG:** maximale Länge pro Einspeisepunkt 10m LED/ **Attention:** Maximum length per feed point 10m



ART. NR./CODE	LEISTUNG/POWER	V DC	LM/M	CRI>	KELVIN	L x B x H/L x W x H	VE/PACKAGE	PREIS/PRICE
746-1242420uw	LED 4,8W/m	24	400	80	2700	5000 x 8 x 3	Rolle/Roll	44,50
746-1242420ww	LED 4,8W/m	24	440	80	3000	5000 x 8 x 3	Rolle/Roll	44,50
746-1242420nw	LED 4,8W/m	24	473	80	4000	5000 x 8 x 3	Rolle/Roll	44,50
746-1242420uwkonf	LED 4,8W/m	24	400	80	2700	lt. order x 8 x 3	per Meter/per Metre	8,50
746-1242420wwkonf	LED 4,8W/m	24	440	80	3000	lt. order x 8 x 3	per Meter/per Metre	8,50
746-1242420nwkonf	LED 4,8W/m	24	473	80	4000	lt. order x 8 x 3	per Meter/per Metre	8,50

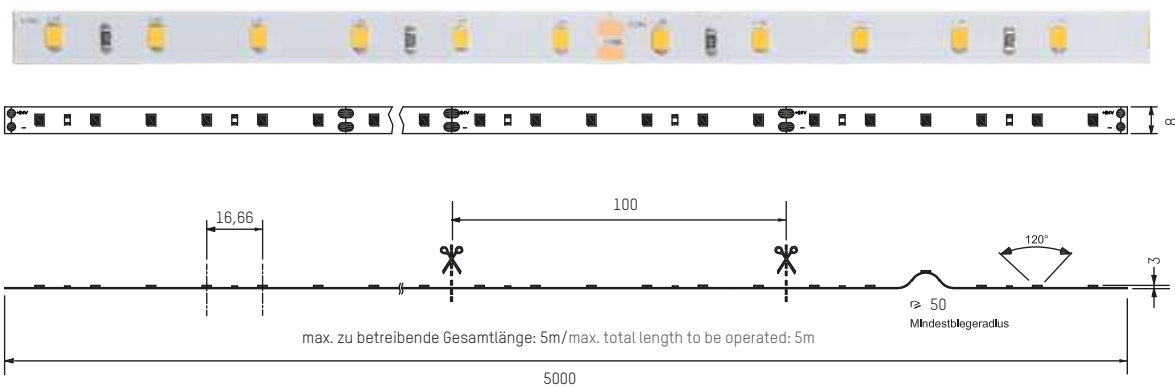

**FLEX.light BASIC 9,6W**

**ACHTUNG:** maximale Länge pro Einspeisepunkt 7m LED/ **Attention:** Maximum length per feed point 7m



ART. NR./CODE	LEISTUNG/POWER	V DC	LM/M	CRI>	KELVIN	L x B x H/L x W x H	VE/PACKAGE	PREIS/PRICE
746-1244820uw	LED 9,6W/m	24	900	80	2700	5000 x 8 x 3	Rolle/Roll	45,50
746-1244820ww	LED 9,6W/m	24	983	80	3000	5000 x 8 x 3	Rolle/Roll	45,50
746-1244820nw	LED 9,6W/m	24	1006	80	4000	5000 x 8 x 3	Rolle/Roll	45,50
746-1244820uwkonf	LED 9,6W/m	24	900	80	2700	lt. order x 8 x 3	per Meter/per Metre	9,50
746-1244820wwkonf	LED 9,6W/m	24	983	80	3000	lt. order x 8 x 3	per Meter/per Metre	9,50
746-1244820nwkonf	LED 9,6W/m	24	1006	80	4000	lt. order x 8 x 3	per Meter/per Metre	9,50

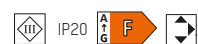

**SCHNELLEINSPEISER/FAST POWER FEED**

ART. NR./CODE	INFO	PREIS/PRICE
746-fc1220w	inkl. 200mm Kabel/ incl. 200mm cable	3,20



**SCHNELLVERBINDER/FAST CONNECTOR**

ART. NR./CODE	PREIS/PRICE
746-lc1220w	1,60



**LINEARVERBINDER/LINEAR CONNECTOR**

ART. NR./CODE	INFO	PREIS/PRICE
746-lcf1220w	inkl. 100mm Kabel/ incl. 100mm cable	3,20



**KONFEKTIONIERUNG FLEX.light BASIC/ASSEMBLY FLEX.light BASIC**

ART. NR./CODE	INFO	PREIS/PRICE
746-konfip20	LED Band IP20 pro Zuschnitt beinhaltet: Zuschnitt, 50cm Anschlusskabel gelötet, Systemtest, ESD-Verpackung/ cut to size, 50cm soldered connection cable, cut seal, system test, ESD packing	21,60





Flexibles BASIC LED Stripe, Rolle 5000mm, 300 SMD3528 LEDs, 60 LEDs/M, 4,8, 9,6 und 14,4W/M, 3step macadam binning, trennbar alle 6 LEDs (ca. 10cm), Befestigung durch doppel-seitiges 3M Klebeband, exkl. Konverter.

**ACHTUNG:** Keine Beständigkeit gegen chemische Substanzen oder Dämpfe (z.B. Chlor u. dgl.); Um eine lange Lebensdauer und einwandfreie Funktion der LED-Stripes zu garantieren, ist eine Montage auf wärmeleitendem Material Voraussetzung! Bitte kalkulieren Sie pro Zuschnitt 1x Art.-Nr.: 746-konf zusätzlich

Flexible BASIC LED stripe, roll 5000mm, 300 SMD3528 LEDs, 60 LEDs/m, 4,8, 9,6 and 14,4W/m, separable each 6 LEDs (ca. 10cm), fixing with double-sided adhesive tape 3M, without driver, please calculate per cut 1x code: 746-konf additionally.

**Attention:** No resistance to chemical substances or vapours (e.g. chlorine and similar).

In order to guarantee a long service life and perfect functioning of the LED stripes, they must be mounted on heat conducting material!

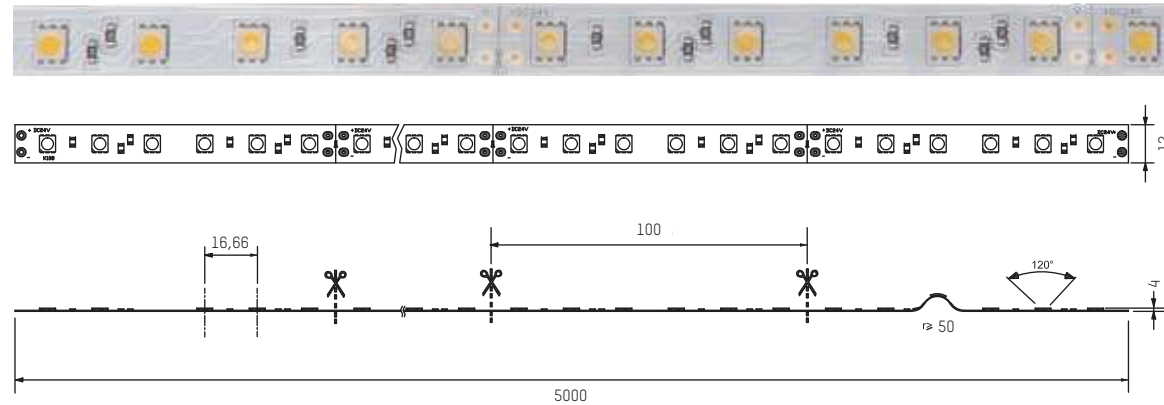

**FLEX.light BASIC 14,4W**

**ACHTUNG:** maximale Länge pro Einspeisepunkt 5m LED/ **Attention:** Maximum length per feed point 5m



ART. NR./CODE	LEISTUNG/POWER	V DC	LM/M	CRI>	KELVIN	L x B x H/L x W x H	VE/PACKAGE	PREIS/PRICE
746-1247220uw	LED 14,4W/m	24	1280	80	2700	5000 x 12 x 4	Rolle/Roll	85,80
746-1247220ww	LED 14,4W/m	24	1395	80	3000	5000 x 12 x 4	Rolle/Roll	85,80
746-1247220nw	LED 14,4W/m	24	1475	80	4000	5000 x 12 x 4	Rolle/Roll	85,80
746-1247220uwkonf	LED 14,4W/m	24	1280	80	2700	lt. order x 12 x 4	per Meter/per Metre	16,90
746-1247220wwkonf	LED 14,4W/m	24	1395	80	3000	lt. order x 12 x 4	per Meter/per Metre	16,90
746-1247220nwkonf	LED 14,4W/m	24	1475	80	4000	lt. order x 12 x 4	per Meter/per Metre	16,90

**SCHNELLEINSPEISER/FAST POWER FEED**

ART. NR./CODE	INFO	PREIS/PRICE
746-fc2420w	inkl. 200mm Kabel/ incl. 200mm cable	2,10

**SCHNELLVERBINDER/FAST CONNECTOR**

ART. NR./CODE	PREIS/PRICE
746-lc2420w	1,60

**LINEARVERBINDER/LINEAR CONNECTOR**

ART. NR./CODE	INFO	PREIS/PRICE
746-lcf2420w	inkl. 100mm Kabel/ incl. 100mm cable	3,70

**KONFEKTIONIERUNG FLEX.light BASIC/ASSEMBLY FLEX.light BASIC**

ART. NR./CODE	INFO	PREIS/PRICE
746-konfip20	LED Band IP20 pro Zuschnitt beinhaltet: Zuschnitt, 50cm Anschlusskabel gelötet, Systemtest, ESD-Verpackung/ cut to size, 50cm soldered connection cable, cut seal, system test, ESD packing	21,60



Projekt: Hotel BERGEBLICK, Bad Tölz, Deutschland, Foto: Molto Luce



Flexibles BASIC LED Stripe, Rolle 5000mm, 120 SMD2835 LEDs pro Meter 14,4W/M, 3step macadam binning, trennbar alle 10cm, Befestigung durch doppelseitiges 3M Klebeband, exkl. Konverter

**ACHTUNG:** Keine Beständigkeit gegen chemische Substanzen oder Dämpfe (z.B. Chlor u. dgl.); Um eine lange Lebensdauer und einwandfreie Funktion der LED-Stripes zu garantieren, ist eine Montage auf wärmeleitendem Material Voraussetzung!

Flexible DIM2WARM stripe 14,4W per meter, roll 5000mm, 120 SMD2835 LEDs per meter, separable each 10cm, fixing with double-sided adhesive tape 3M, without driver

**Attention:** No resistance to chemical substances or vapours (e.g. chlorine and similar). In order to guarantee a long service life and perfect functioning of the LED stripes, they must be mounted on heat conducting material!

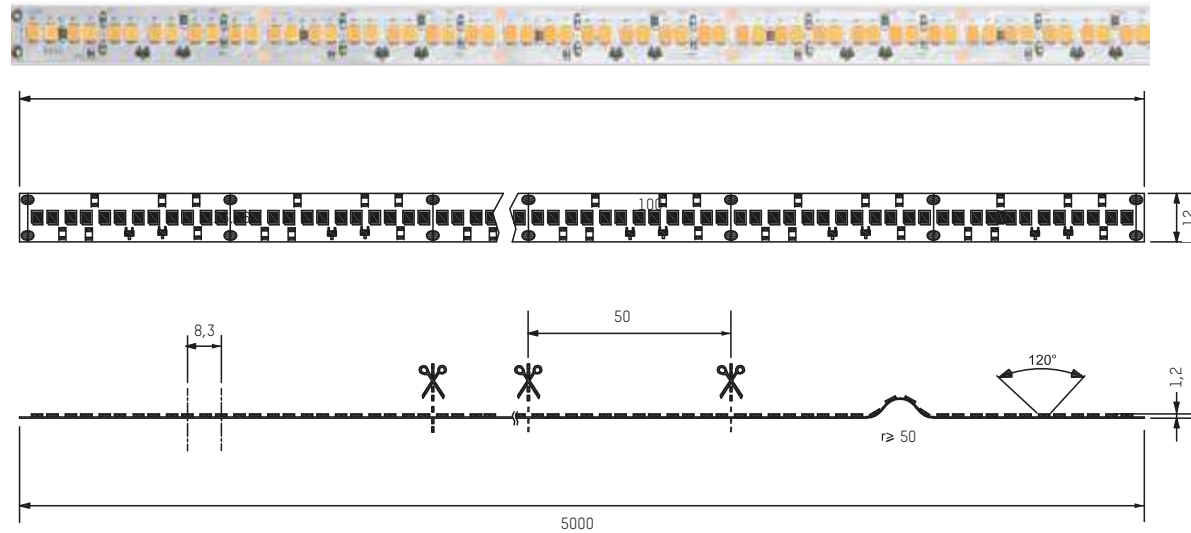

**FLEX.light DIM2WARM 14,4W**

ACHTUNG: maximale Länge pro Einspeisepunkt 5m LED/ Attention: Maximum length per feed point 5m

ART. NR./CODE	LEISTUNG/POWER	V DC	LM/M	CRI>	KELVIN	L x B x H/L x W x H	VE/PACKAGE	PREIS/PRICE
746-247220wd2w	LED 14,4W/m	24	1330	80	2200/3000	5000 x 12 x 1,4	5m Rolle/5m Roll	218,20
746-247220ud2w	LED 14,4W/m	24	1270	80	2200/2700	5000 x 12 x 1,4	5m Rolle/5m Roll	218,20

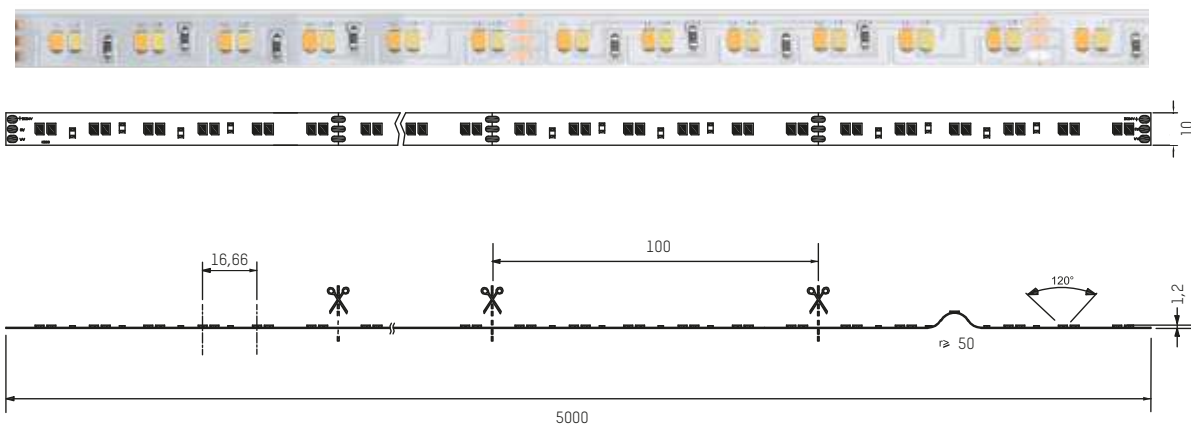

**FLEX.light TUNABLE WHITE 14,4W**

ACHTUNG: maximale Länge pro Einspeisepunkt 5m LED/ Attention: Maximum length per feed point 5m

ART. NR./CODE	LEISTUNG/POWER	V DC	LM/M	CRI>	KELVIN	L x B x H/L x W x H	VE/PACKAGE	PREIS/PRICE
746-241420tw	LED 14,4W/m	24	2700-736 6500-782	80	2700/6500	5000 x 10 x 1,4	5m Rolle/5m Roll	89,00



Projekt: Hotel Almlost, Flachau, Österreich, Foto: Hotel Almlost



Projekt: Private Residence, Österreich, Foto: Molto Luce



Flexibles BASIC LED Stripe RGB-W, Rolle 5000mm, 480 SMD LEDs, 48 SMD RGB 5050 LEDs/Meter, 48 SMD 2835 LEDs/M, 18,1W/M, trennbar alle 12 LEDs (ca. 10cm) Befestigung durch doppelseitiges 3M Klebeband, exkl. Konverter  
**ACHTUNG:** Keine Beständigkeit gegen chemische Substanzen oder Dämpfe (z.B. Chlor u. dgl.); Um eine lange Lebensdauer und einwandfreie Funktion der LED-Stripes zu garantieren, ist eine Montage auf wärmeleitendem Material Voraussetzung!

Flexible RGB-W stripe 18,1W per meter, roll 5000mm, 480 SMD LEDs, 48 SMD RGB 5050 LEDs/m, separable each 10cm, fixing with double-sided adhesive tape 3M, without driver  
**Attention:** No resistance to chemical substances or vapours (e.g. chlorine and similar).  
 In order to guarantee a long service life and perfect functioning of the LED stripes, they must be mounted on heat conducting material!

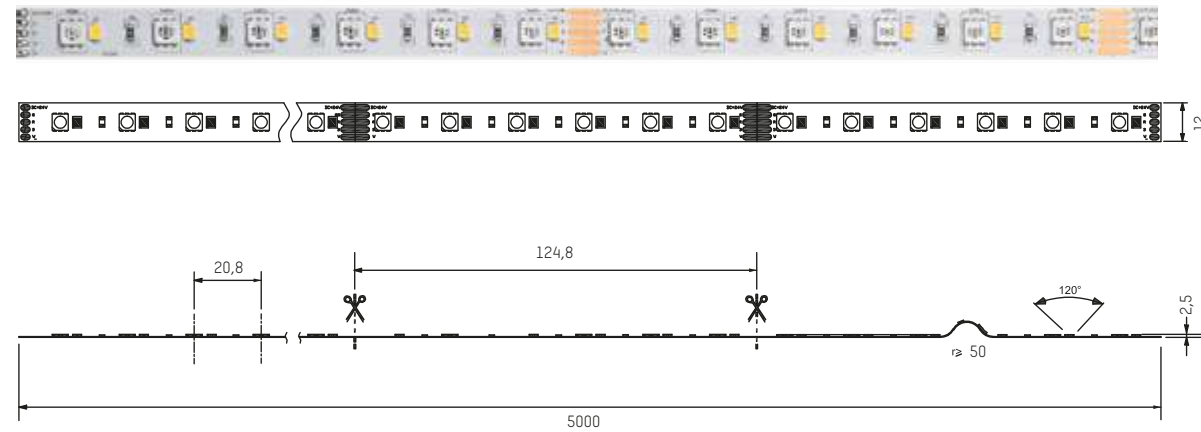

**FLEX.light RGBW 18,1W**

**ACHTUNG:** maximale Länge pro Einspeisepunkt 5m LED/ **Attention:** Maximum length per feed point 5m



ART. NR./CODE	LEISTUNG/POWER	V DC	LM/M	CRI>	KELVIN	L x B x H/L x W x H	VE/PACKAGE	PREIS/PRICE
746-1249120rgbw	LED 18,1W/m	24	101 <span style="color:red">■</span> red 279 <span style="color:green">■</span> green 65 <span style="color:blue">■</span> blue 428 <span style="color:white">■</span> white	---	RGB+ <span style="color:orange">■</span> 3000	5000 x 12 x 2,5	5m Rolle/5m Roll	112,30

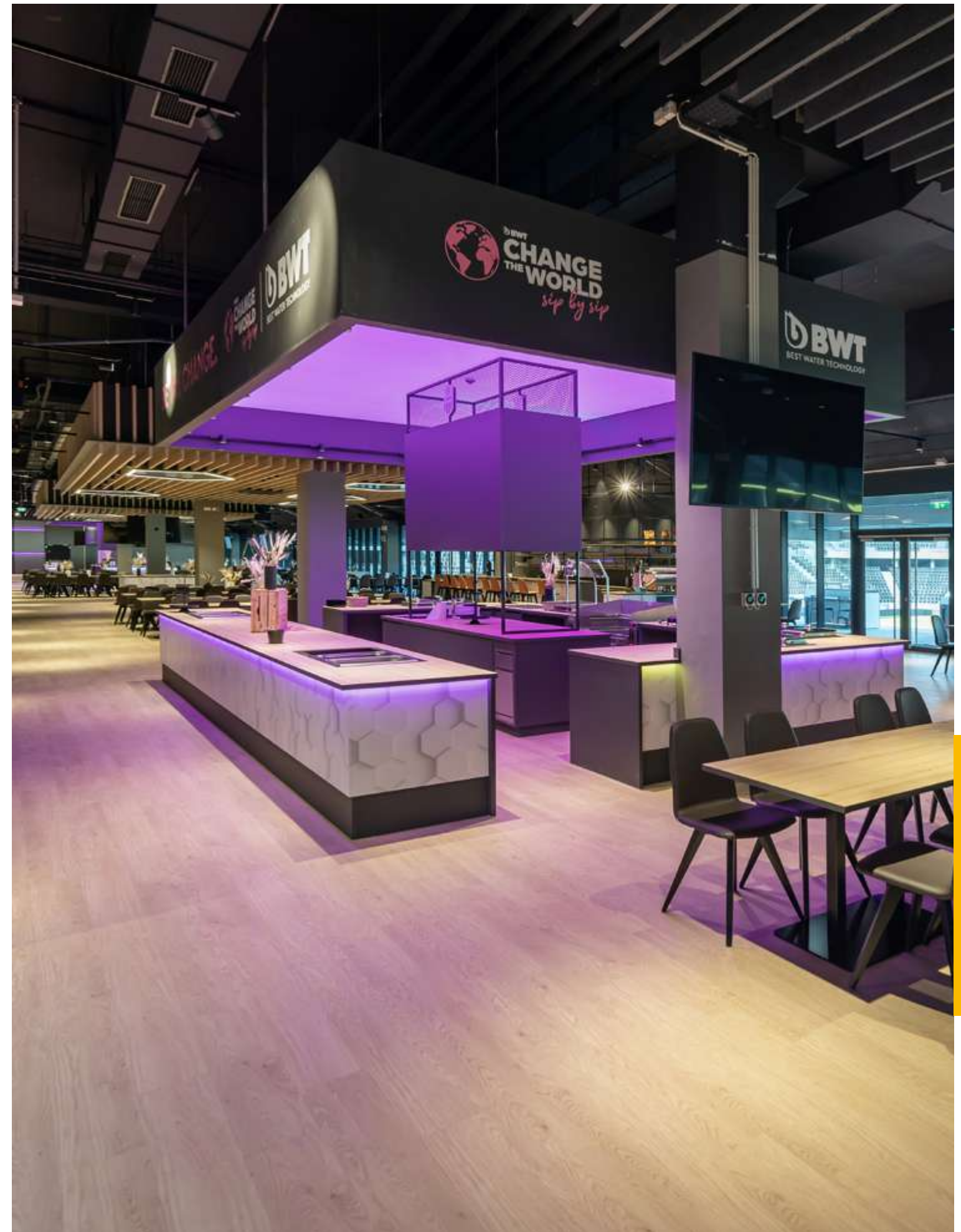



Flexibles BASIC LED Stripe, Rolle 5000mm, 300 SMD3528 LEDs, 60 LEDs/M, 4,8W und 14,4W/M, trennbar alle 6 LEDs (ca. 10cm), Band muss nach Trennung versiegelt werden!, Befestigung durch doppelseitiges 3M Klebeband, inkl. DC Stecker und 2 Buchsen, exkl. Konverter

**ACHTUNG:** Keine Beständigkeit gegen chemische Substanzen oder Dämpfe (z.B. Chlor u. dgl.); Um eine lange Lebensdauer und einwandfreie Funktion der LED-Stripes zu garantieren, ist eine Montage auf wärmeleitendem Material Voraussetzung!

Flexible BASIC LED IP67 stripe, roll 5000mm, 300 SMD5060 LEDs, 60 LEDs/m, 4,8W and 14,4W/m, separable each 6 LEDs (ca. 10cm), Stripe must be sealed after separation! fixing with double-sided adhesive tape 3M, with DC plug and 2 sockets, without driver

**Attention:** No resistance to chemical substances or vapours (e.g. chlorine and similar). In order to guarantee a long service life and perfect functioning of the LED stripes, they must be mounted on heat conducting material!

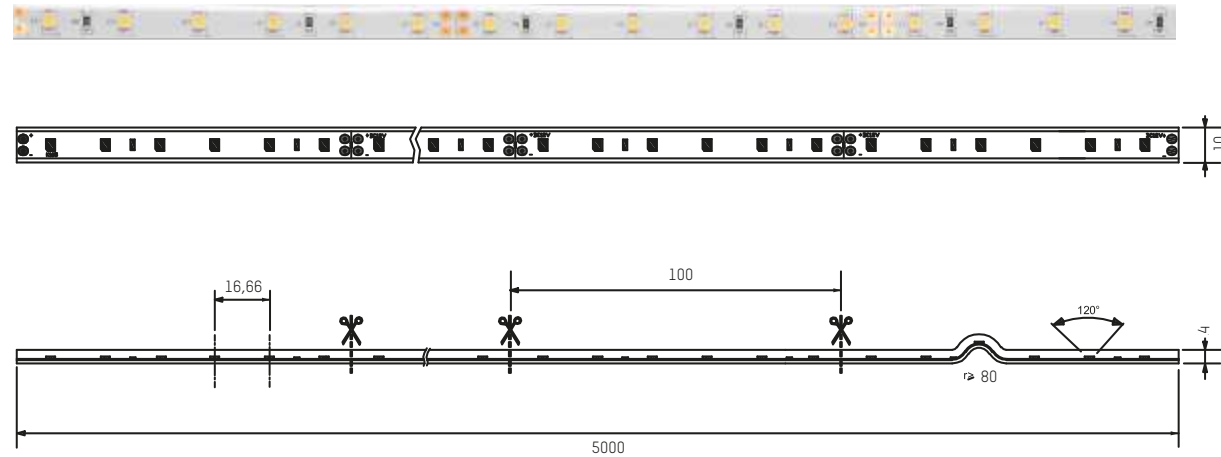

**FLEX.light 4,8W** ACHTUNG: maximale Länge pro Einspeisepunkt 5m LED/ Attention: Maximum length per feed point 5m

ART. NR./CODE	LEISTUNG/POWER	V DC	LM/M	CRI>	KELVIN	L x B x H/L x W x H	VE/PACKAGE	PREIS/PRICE
746-1242467ww	LED 4,8W/m	24	350	80	3000	5000 x 10 x 4	5m Rolle/5m Roll	76,20
746-1242467nw	LED 4,8W/m	24	370	80	4000	5000 x 10 x 4	5m Rolle/5m Roll	76,20

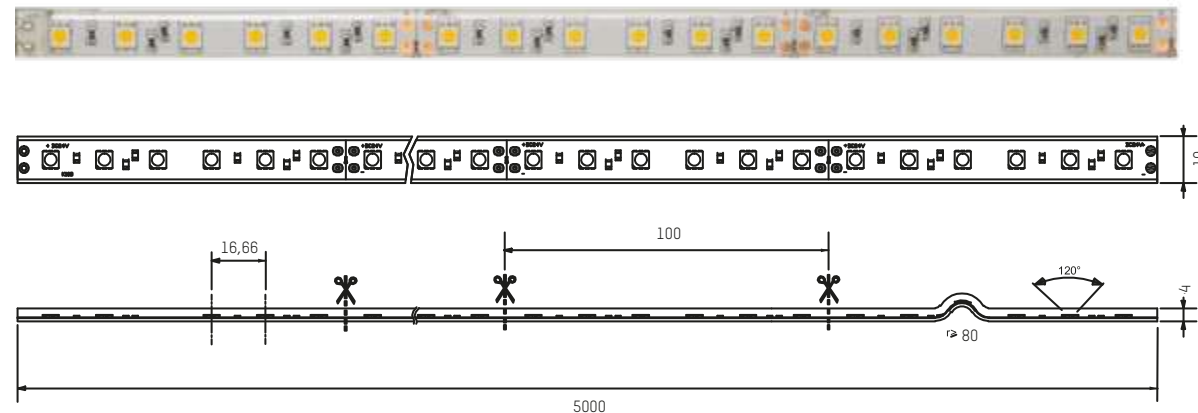

**FLEX.light 14,4W** ACHTUNG: maximale Länge pro Einspeisepunkt 5m LED/ Attention: Maximum length per feed point 5m

ART. NR./CODE	LEISTUNG/POWER	V DC	LM/M	CRI>	KELVIN	L x B x H/L x W x H	VE/PACKAGE	PREIS/PRICE
746-1247267ww	LED 14,4W/m	24	1090	80	3000	5000 x 14,2 x 4	5m Rolle/5m Roll	121,80
746-1247267nw	LED 14,4W/m	24	1130	80	4000	5000 x 14,2 x 4	5m Rolle/5m Roll	121,80



**SILIKONENDKAPPE/SILICON END CAP**

ART. NR./CODE	PREIS/PRICE
746-1001	1,10



**EINSPEISUNGSABDECKUNG/FEED IN COVER**

ART. NR./CODE	PREIS/PRICE
746-1101	1,10



**DC-BUCHSE/DC SOCKET**

ART. NR./CODE	INFO	PREIS/PRICE
746-1200	inkl. 130mm Kabel/ incl. 130mm cable	2,10



**SCHRUMPFSCHLAUCH/SHRINK TUBE**

ART. NR./CODE	PREIS/PRICE
746-1004	0,50



**DC-STECKER/DC PLUG**

ART. NR./CODE	INFO	PREIS/PRICE
746-1100	inkl. 130mm Kabel/ incl. 130mm cable	2,10

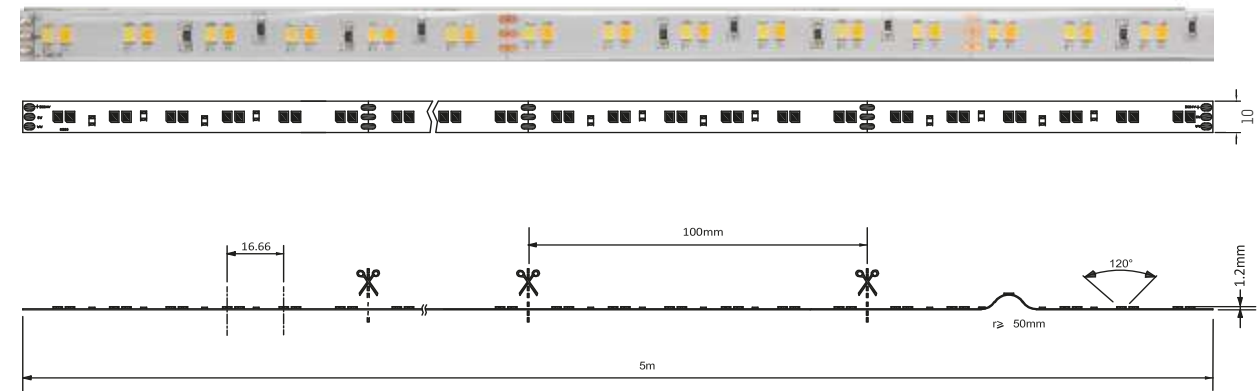

**FLEX.light TUNABLE WHITE 14,4W**

ACHTUNG: maximale Länge pro Einspeisepunkt 5m LED/ Attention: Maximum length per feed point 5m



ART. NR./CODE	LEISTUNG/POWER	V DC	LM/M	CRI>	KELVIN	L x B x H/L x W x H	VE/PACKAGE	PREIS/PRICE
746-241467tw	LED 14,4W/m	24	519 526	80	2700- 6500	5000 x 12 x 5,5	5m Rolle/5m Roll	128,10



**SILIKONENDKAPPE/SILICON END CAP**

ART. NR./CODE	PREIS/PRICE
746-1006	1,10



**EINSPEISUNGSABDECKUNG/FEED IN COVER**

ART. NR./CODE	PREIS/PRICE
746-1102	1,10



**SCHRUMPFSCHLAUCH/SHRINK TUBE**

ART. NR./CODE	PREIS/PRICE
746-1004	0,50



Flexibles BASIC LED Stripe; 48V Versorgungsspannung, Rolle 10m, 120 LED/M, 5step macadam binning, trennbar alle 10cm, Band muss nach Trennung versiegelt werden! Befestigung durch doppelseitiges 3M Klebeband, exkl. Konverter  
**ACHTUNG:** Keine Beständigkeit gegen chemische Substanzen oder Dämpfe (z.B. Chlor u. dgl.); Um eine lange Lebensdauer und einwandfreie Funktion der LED-Stripes zu garantieren, ist eine Montage auf wärmeleitendem Material Voraussetzung!

Flexible BASIC LED 48V IP67 stripe, roll 10m, 120 LEDs/m, 4,8W/m, separable each 10cm, Stripe must be sealed after separation! fixing with double-sided adhesive tape 3M, without driver  
**Attention:** No resistance to chemical substances or vapours (e.g. chlorine and similar). In order to guarantee a long service life and perfect functioning of the LED stripes, they must be mounted on heat conducting material!

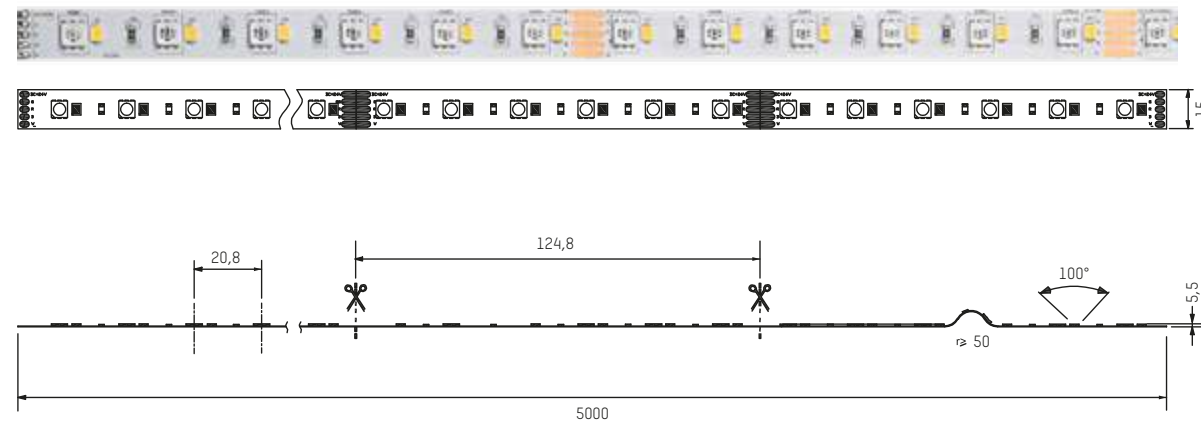

**FLEX.light RGBW 18,1W**

**ACHTUNG:** maximale Länge pro Einspeisepunkt 5m LED/  
**Attention:** Maximum length per feed point 5m



ART. NR./CODE	LEISTUNG/POWER	V DC	LM/M	CRI>	KELVIN	L x B x H/L x W x H	VE/PACKAGE	PREIS/PRICE
746-1249167rgbw	LED 18,1W/m	24	78 red 198 green 52 blue 294 white	80 WHITE	RGB+ 3000	5000 x 15 x 5,5	5m Rolle/5m Roll	147,20



Projekt: Dorfbahn, Gerlos, Österreich, Foto: Dorfbahn Gerlos



Projekt: Cafe Central, Linz, Österreich, Foto: LSD



Flexibles BASIC LED Stripe; 48V Versorgungsspannung, Rolle 10m, 120 LED/M, 5step macadam binning, trennbar alle 10cm, Band muss nach Trennung versiegelt werden! Befestigung durch doppelseitiges 3M Klebeband, exkl. Konverter

**ACHTUNG:** Keine Beständigkeit gegen chemische Substanzen oder Dämpfe (z.B. Chlor u. dgl.); Um eine lange Lebensdauer und einwandfreie Funktion der LED-Stripes zu garantieren, ist eine Montage auf wärmeleitendem Material Voraussetzung!

Flexible BASIC LED 48V IP67 stripe, roll 10m, 120 LEDs/m, 4,8W/m, separable each 10cm, Stripe must be sealed after separation! fixing with double-sided adhesive tape 3M, without driver

**Attention:** No resistance to chemical substances or vapours (e.g. chlorine and similar). In order to guarantee a long service life and perfect functioning of the LED stripes, they must be mounted on heat conducting material!

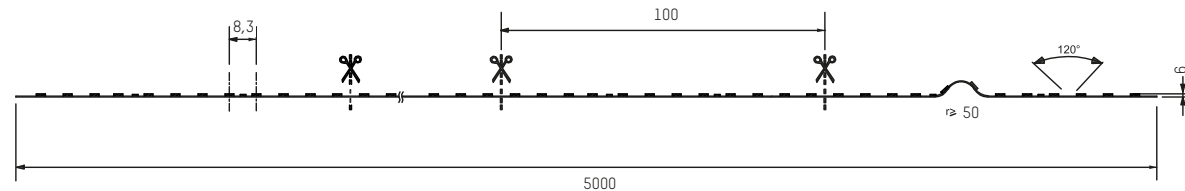
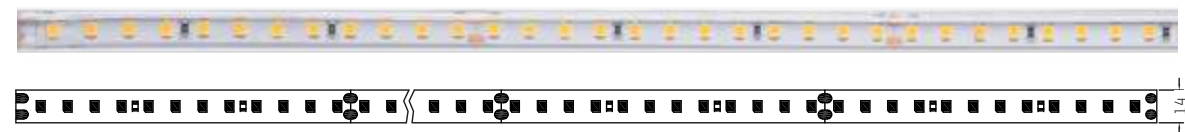

48V

**FLEX.light BASIC 48V IP67 4,8W**

**ACHTUNG:** maximale Länge pro Einspeisepunkt 10m LED/  
**Attention:** Maximum length per feed point 10m



ART. NR./CODE	LEISTUNG/POWER	V DC	LM/M	CRI>	KELVIN	L x B x H/L x W x H	VE/PACKAGE	PREIS/PRICE
746-484867ww	LED 4,8W/m	48	418	80	3000	10000 x 14 x 6	10m Rolle/10m Roll	193,80
746-484867nw	LED 4,8W/m	48	420	80	4000	10000 x 14 x 6	10m Rolle/10m Roll	193,80



**SILIKONENDKAPPE/SILICON END CAP**



ART. NR./CODE	PREIS/PRICE
746-1007	1,10

**SCHRUMPFSCHLAUCH/SHRINK TUBE**



ART. NR./CODE	PREIS/PRICE
746-1004	0,50

**EINSPEISUNGSABDECKUNG/FEED IN COVER**



ART. NR./CODE	PREIS/PRICE
746-1104	2,10

**DC-STECKER/DC PLUG**



ART. NR./CODE	INFO	PREIS/PRICE
746-1100	inkl. 130mm Kabel/ incl. 130mm cable	2,10

**DC-BUCHSE/DC SOCKET**



ART. NR./CODE	INFO	PREIS/PRICE
746-1200	inkl. 130mm Kabel/ incl. 130mm cable	2,10



**KONVERTER 50W SCHALTBAR/DRIVER 50W ON/OFF**

ART. NR./CODE	INFO	W	V DC	V AC	L x B x H/L x W x H	FARBE/COLOUR	PREIS/PRICE
24-122766	nicht dimmbar/ not dimmable	50	48	230	225 x 60 x 49	white	66,70



**KONVERTER 150W SCHALTBAR/DRIVER 150W ON/OFF**

ART. NR./CODE	INFO	W	V DC	V AC	L x B x H/L x W x H	FARBE/COLOUR	PREIS/PRICE
24-122764	nicht dimmbar/ not dimmable	150	48	230	240 x 60 x 49	white	141,90



**UNIVERSALDIMMER/UNIVERSALDIMMER**

ART. NR./CODE	INFO	V DC	L x B x H/L x W x H	FARBE/COLOUR	PREIS/PRICE
322-ud3000	Universaldimmer 1 Kanal, separater Steuereingang für DALI, 1-10V, Push, Sync Anschluß für bis zu 9 Slaves bei 1-10V oder Push Ansteuerung, max. Anschluß: 5A Zugentlastung separat ordern <b>ZUGENTLASTUNG</b> für 1-Kanal Universaldimmer, 2 Stück	15-50	153 x 30 x 21	white	123,00
322-ud7001	Universal dimmer 1 channel, separate control input for DALI, 1-10V, Push, Sync connection for up to 9 slaves with 1-10V or Push control, max. connection: 5A Strain relief to be ordered separately <b>STAIN RELIEF</b> for 1-channel universal dimmer, 2 pcs.				12,70





# AUFBAU/EINBAUPROFILE SURFACE/RECESSED PROFILES

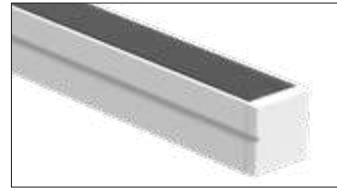

**MINI 10 AUFBAU/SURFACE**  
Info: S. 254/P. 254



**MINI 14 AUFBAU/SURFACE**  
Info: S. 254/P. 254



**MINI 17 AUFBAU/SURFACE**  
Info: S. 255/P. 255

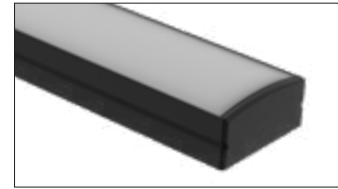

**MIDI AUFBAU/SURFACE**  
Info: S. 255/P. 255

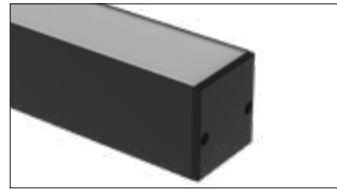

**MAXI AUFBAU/SURFACE**  
Info: S. 256/P. 256

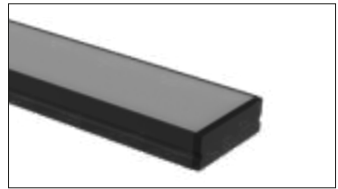

**MEGA AUFBAU/SURFACE**  
Info: S. 256/P. 256



**MINI CORNER AUFBAU/SURFACE**  
Info: S. 257/P. 257

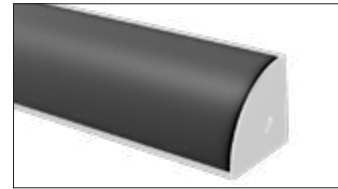

**MIDI CORNER AUFBAU/SURFACE**  
Info: S. 257/P. 257

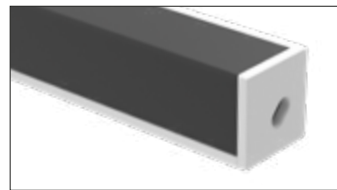

**MIDI CORNER AUFBAU/SURFACE**  
Info: S. 258/P. 258

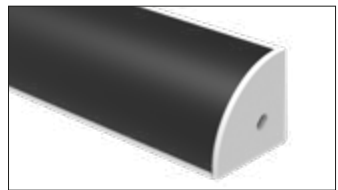

**MAXI CORNER AUFBAU/SURFACE**  
Info: S. 258/P. 258

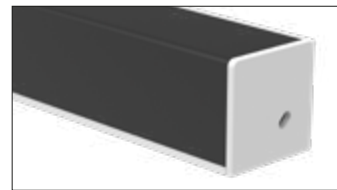

**MAXI CORNER AUFBAU/SURFACE**  
Info: S. 259/P. 259

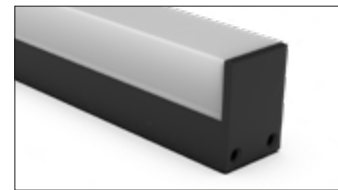

**MIDI CUBE AUFBAU/SURFACE**  
Info: S. 260/P. 260

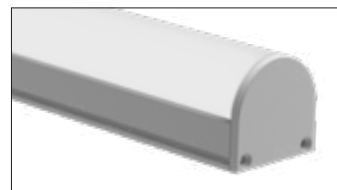

**MAXI SOFT AUFBAU/SURFACE**  
Info: S. 260/P. 260



**FLEX AUFBAU/SURFACE**  
Info: S. 261/P. 261



**MINI 10 EINBAU/RECESSED**  
Info: S. 262/P. 262

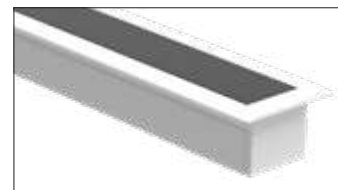

**MINI 14 EINBAU/RECESSED**  
Info: S. 262/P. 262



**MINI 17 EINBAU/RECESSED**  
Info: S. 263/P. 263

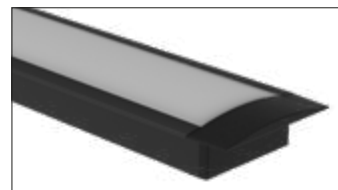

**MIDI EINBAU/RECESSED**  
Info: S. 263/P. 263



**MAXI EINBAU/RECESSED**  
Info: S. 264/P. 264

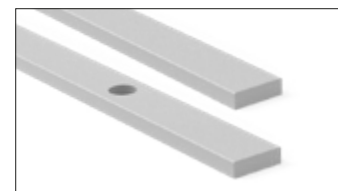

**ZUBEHÖR/ACCESSOIRES**  
Info: S. 264/P. 264





## AUFBAUPROFILE AUS ALUMINIUM/SURFACE ALUMINIUM PROFILES

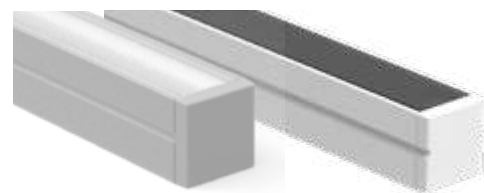

Aufbauprofil MINI 10 für LED Flexbänder bis Breite 5mm

**HINWEIS:** für LED Bänder bis max. 5 Watt

Surface profile MINI 10 for flexible LED stripes up to width 5mm

**INFO:** for LED stripes up to: 5 Watt

## MINI 10 AUFBAU/MINI 10 SURFACE

ART. NR./CODE	INFO	DETAIL/DETAIL	L x B x H/L x W x H	FARBE/COLOUR	PREIS/PRICE
600-1a201w	Profil/Profile		2000 x 10 x 10	<input type="checkbox"/> white	10,00
600-1a201b	Profil/Profile		2000 x 10 x 10	<input checked="" type="checkbox"/> black	10,00
600-1a201s	Profil/Profile		2000 x 10 x 10	<input type="checkbox"/> alu anodized	10,60
	INFO	DETAIL/DETAIL	MATERIAL/MATERIAL	FARBE/COLOUR	PREIS/PRICE
600-1aek201w	Endkappen (2 Stk.)/End Piece (2 pcs.)		Kunststoff/plastic	<input type="checkbox"/> white	1,10
600-1aek201b	Endkappen (2 Stk.)/End Piece (2 pcs.)		Kunststoff/plastic	<input checked="" type="checkbox"/> black	1,10
600-1aek201s	Endkappen (2 Stk.)/End Piece (2 pcs.)		Kunststoff/plastic	<input type="checkbox"/> grey	1,10
600-1c201	Abdeckung/Cover		PMMA Weiß opal/PMMA white opal	<input type="checkbox"/> white opal	5,00
600-cb201	Abdeckung/Cover		PMMA Schwarz opal/PMMA black opal	<input checked="" type="checkbox"/> black opal	7,00
600-mc201	Montageclips (2 Stk.)/ Mounting Clips (2 pcs.)		Edelstahl/Stainless Steel	<input type="checkbox"/> stainless steel	1,10

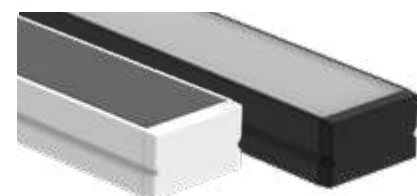

Aufbauprofil MINI 14 für LED Flexbänder bis Breite 8mm

**HINWEIS:** für LED Bänder bis max. 9 Watt

Surface profile MINI 14 for flexible LED stripes up to width 8mm

**INFO:** for LED stripes up to: 9 Watt

## MINI 14 AUFBAU/MINI 14 SURFACE

ART. NR./CODE	INFO	DETAIL/DETAIL	L x B x H/L x W x H	FARBE/COLOUR	PREIS/PRICE
600-1a202w	Profil/Profile		2000 x 14 x 8	<input type="checkbox"/> white	11,00
600-1a202b	Profil/Profile		2000 x 14 x 8	<input checked="" type="checkbox"/> black	10,00
600-1a202s	Profil/Profile		2000 x 14 x 8	<input type="checkbox"/> alu anodized	11,00
	INFO	DETAIL/DETAIL	MATERIAL/MATERIAL	FARBE/COLOUR	PREIS/PRICE
600-1aek202w	Endkappen (2 Stk.)/End Piece (2 pcs.)		Kunststoff/plastic	<input type="checkbox"/> white	1,60
600-1aek202b	Endkappen (2 Stk.)/End Piece (2 pcs.)		Kunststoff/plastic	<input checked="" type="checkbox"/> black	1,60
600-1aek202s	Endkappen (2 Stk.)/End Piece (2 pcs.)		Kunststoff/plastic	<input type="checkbox"/> grey	1,60
600-1c202	Abdeckung/Cover		PMMA Weiß opal/PMMA white opal	<input type="checkbox"/> white opal	7,00
600-cb202	Abdeckung/Cover		PMMA Schwarz opal/PMMA black opal	<input checked="" type="checkbox"/> black opal	7,00
600-amc202	Montageclips (2 Stk.)/ Mounting Clips (2 pcs.)		Edelstahl/Stainless Steel	<input type="checkbox"/> stainless steel	1,10



Aufbauprofil MINI 17 für LED Flexbänder bis Breite 12mm

**HINWEIS:** für LED Bänder bis max. 18 Watt

Surface profile MINI 17 for flexible LED stripes up to width 12mm

**INFO:** for LED stripes up to: 18 Watt

## MINI 17 AUFBAU/MINI 17 SURFACE

ART. NR./CODE	INFO	DETAIL/DETAIL	L x B x H/L x W x H	FARBE/COLOUR	PREIS/PRICE
600-a203w	Profil/Profile		2000 x 17 x 8,8	<input type="checkbox"/> white	12,00
600-a203b	Profil/Profile		2000 x 17 x 8,8	<input checked="" type="checkbox"/> black	15,00
600-a203s	Profil/Profile		2000 x 17 x 8,8	<input type="checkbox"/> alu anodized	12,00
	INFO	DETAIL/DETAIL	MATERIAL/MATERIAL	FARBE/COLOUR	PREIS/PRICE
600-aek203w	Endkappen (2 Stk.)/End Piece (2 pcs.)		Kunststoff/plastic	<input type="checkbox"/> white	1,60
600-aek203b	Endkappen (2 Stk.)/End Piece (2 pcs.)		Kunststoff/plastic	<input checked="" type="checkbox"/> black	1,60
600-aek203s	Endkappen (2 Stk.)/End Piece (2 pcs.)		Kunststoff/plastic	<input type="checkbox"/> grey	1,60
600-c203	Abdeckung/Cover		PMMA Weiß opal/PMMA white opal	<input type="checkbox"/> white opal	7,00
600-mc203	Montageclips (2 Stk.)/ Mounting Clips (2 pcs.)		Edelstahl/Stainless Steel	<input type="checkbox"/> stainless steel	1,60

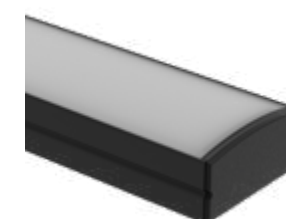

Aufbauprofil MIDI für LED Flexbänder bis Breite 15mm

**HINWEIS:** für LED Bänder bis max. 28 Watt

Surface profile MIDI for flexible LED stripes up to width 15mm

**INFO:** for LED stripes up to: 28 Watt

## MIDI AUFBAU/MIDI SURFACE

ART. NR./CODE	INFO	DETAIL/DETAIL	L x B x H/L x W x H	FARBE/COLOUR	PREIS/PRICE
600-a204w	Profil/Profile		2000 x 23 x 11,2	<input type="checkbox"/> white	18,00
600-a204b	Profil/Profile		2000 x 23 x 11,2	<input checked="" type="checkbox"/> black	18,00
600-a204s	Profil/Profile		2000 x 23 x 11,2	<input type="checkbox"/> alu anodized	18,00
	INFO	DETAIL/DETAIL	MATERIAL/MATERIAL	FARBE/COLOUR	PREIS/PRICE
600-aek204w	Endkappen (2 Stk.)/End Piece (2 pcs.)		Kunststoff/plastic	<input type="checkbox"/> white	2,10
600-aek204b	Endkappen (2 Stk.)/End Piece (2 pcs.)		Kunststoff/plastic	<input checked="" type="checkbox"/> black	2,10
600-aek204s	Endkappen (2 Stk.)/End Piece (2 pcs.)		Kunststoff/plastic	<input type="checkbox"/> grey	2,10
600-c204	Abdeckung/Cover		PMMA Weiß opal/PMMA white opal	<input type="checkbox"/> white opal	9,00
600-ck204	Abdeckung/Cover		PMMA transparent/PMMA transparent	<input type="checkbox"/> transparent	9,00
600-mc204	Montageclips (2 Stk.)/ Mounting Clips (2 pcs.)		Edelstahl/Stainless Steel	<input type="checkbox"/> stainless steel	1,60



**AUFBAUPROFILE AUS ALUMINIUM/SURFACE ALUMINIUM PROFILES**

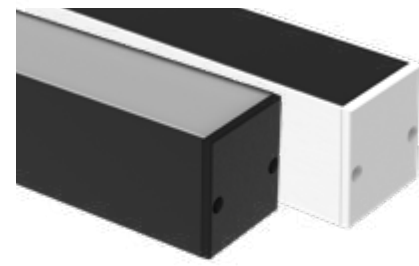

Aufbauprofil MAXI für LED Flexbänder bis Breite 15mm  
**HINWEIS:** für LED Bänder bis max. 28 Watt  
 Surface profile MAXI for flexible LED stripes up to width 15mm  
**INFO:** for LED stripes up to: 28 Watt



**MAXI AUFBAU/MAXI SURFACE**

ART. NR./CODE	INFO	DETAIL/DETAIL	L x B x H / L x W x H	FARBE/COLOUR	PREIS/PRICE
600-a205w	Profil/Profile		2000 x 23 x 25	white	29,00
600-a205b	Profil/Profile		2000 x 23 x 25	black	29,00
600-a205s	Profil/Profile		2000 x 23 x 25	alu anodized	25,00
	INFO	DETAIL/DETAIL	MATERIAL/MATERIAL	FARBE/COLOUR	PREIS/PRICE
600-aek205w	Endkappen (2 Stk.)/End Piece (2 pcs.)		Kunststoff/plastic	white	2,60
600-aek205b	Endkappen (2 Stk.)/End Piece (2 pcs.)		Kunststoff/plastic	black	2,90
600-aek205s	Endkappen (2 Stk.)/End Piece (2 pcs.)		Kunststoff/plastic	grey	2,60
600-aekc205w	Endkappen (2 Stk.)/End Piece (2 pcs.)		Kunststoff (H 25 mm)/plastic	white	2,60
600-aekc205b	Endkappen (2 Stk.)/End Piece (2 pcs.)		Kunststoff (H 25 mm)/plastic	black	2,60
600-aekc205s	Endkappen (2 Stk.)/End Piece (2 pcs.)		Kunststoff (H 25 mm)/plastic	grey	2,60
600-c205	Abdeckung flach/Cover flat		PMMA Weiß opal/PMMA white opal	white opal	9,00
600-cu205	Abdeckung kubisch/Cover cubic		PMMA Weiß opal/PMMA white opal	white opal	19,00
600-cb205	Abdeckung flach/Cover flat		PMMA Schwarz opal/PMMA black opal	black opal	10,00
600-amc205	Montageclips (2 Stk.)/ Mounting Clips (2 pcs.)		Edelstahl/Stainless Steel	stainless steel	2,10



Aufbauprofil MEGA für LED Flexbänder bis Breite 15mm  
**HINWEIS:** für LED Bänder bis max. 28 Watt  
 Surface profile MEGA for flexible LED stripes up to width 15mm  
**INFO:** for LED stripes up to: 28 Watt



**MEGA AUFBAU/MEGA SURFACE**

ART. NR./CODE	INFO	DETAIL/DETAIL	L x B x H / L x W x H	FARBE/COLOUR	PREIS/PRICE
600-a206w	Profil/Profile		2000 x 30 x 10,1	white	19,00
600-a206b	Profil/Profile		2000 x 30 x 10,1	black	19,00
600-a206s	Profil/Profile		2000 x 30 x 10,1	alu anodized	24,00
	INFO	DETAIL/DETAIL	MATERIAL/MATERIAL	FARBE/COLOUR	PREIS/PRICE
600-aek206w	Endkappen (2 Stk.)/End Piece (2 pcs.)		Kunststoff/plastic	white	2,60
600-aek206b	Endkappen (2 Stk.)/End Piece (2 pcs.)		Kunststoff/plastic	black	2,60
600-aek206s	Endkappen (2 Stk.)/End Piece (2 pcs.)		Kunststoff/plastic	grey	2,60
600-c206	Abdeckung/Cover		PMMA Weiß opal/PMMA white opal	white opal	9,00
600-amc206	Montageclips (2 Stk.)/ Mounting Clips (2 pcs.)		Edelstahl/Stainless Steel	stainless steel	2,10

**ECKPROFILE AUS ALUMINIUM/CORNER ALUMINIUM PROFILES**

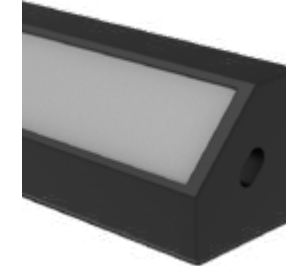

Aufbauprofil MINI CORNER für LED Flexbänder bis Breite 8mm  
**HINWEIS:** für LED Bänder bis max. 12 Watt  
 Surface profile MINI CORNER for flexible LED stripes up to width 8mm  
**INFO:** for LED stripes up to: 12 Watt



**MINI CORNER AUFBAU/MINI CORNER SURFACE**

ART. NR./CODE	INFO	DETAIL/DETAIL	L x B x H / L x W x H	FARBE/COLOUR	PREIS/PRICE
600-1a209w	Profil/Profile		2000 x 18,5 x 18,5	white	22,00
600-1a209b	Profil/Profile		2000 x 18,5 x 18,5	black	22,00
600-1a209s	Profil/Profile		2000 x 18,5 x 18,5	alu anodized	22,00
	INFO	DETAIL/DETAIL	MATERIAL/MATERIAL	FARBE/COLOUR	PREIS/PRICE
600-1aek209w	Endkappen (2 Stk.)/End Piece (2 pcs.)		Kunststoff/plastic	white	2,10
600-1aek209b	Endkappen (2 Stk.)/End Piece (2 pcs.)		Kunststoff/plastic	black	2,10
600-1aek209s	Endkappen (2 Stk.)/End Piece (2 pcs.)		Kunststoff/plastic	alu anodized	2,10
600-1c209	Abdeckung/Cover		PMMA Weiß opal/PMMA white opal	white opal	7,00
600-amc209	Montageclips (2 Stk.)/ Mounting Clips (2 pcs.)		Edelstahl/Stainless Steel	stainless steel	2,10



Aufbauprofil MIDI CORNER für LED Flexbänder bis Breite 8mm  
**HINWEIS:** für LED Bänder bis max. 9 Watt  
 Surface profile MIDI CORNER for flexible LED stripes up to width 8mm  
**INFO:** for LED stripes up to: 9 Watt



**MIDI CORNER AUFBAU/MIDI CORNER SURFACE**

ART. NR./CODE	INFO	DETAIL/DETAIL	L x B x H / L x W x H	FARBE/COLOUR	PREIS/PRICE
600-a207w	Profil/Profile		2000 x 16 x 16	white	19,00
600-a207b	Profil/Profile		2000 x 16 x 16	black	16,00
600-a207s	Profil/Profile		2000 x 16 x 16	alu anodized	16,00
	INFO	DETAIL/DETAIL	MATERIAL/MATERIAL	FARBE/COLOUR	PREIS/PRICE
600-aekr207w	Endkappen (2 Stk.)/End Piece (2 pcs.)		Kunststoff/plastic	white	2,50
600-aekr207b	Endkappen (2 Stk.)/End Piece (2 pcs.)		Kunststoff/plastic	black	2,10
600-aekr207s	Endkappen (2 Stk.)/End Piece (2 pcs.)		Kunststoff/plastic	grey	2,10
600-cr207	Abdeckung/Cover		PMMA Weiß opal/PMMA white opal	white opal	8,00
600-crb207	Abdeckung/Cover		PMMA Schwarz opal/PMMA black opal	black opal	9,00
600-amc207	Montageclips (2 Stk.)/ Mounting Clips (2 pcs.)		Edelstahl/Stainless Steel	stainless steel	1,90



## ECKPROFILE AUS ALUMINIUM/CORNER ALUMINIUM PROFILES

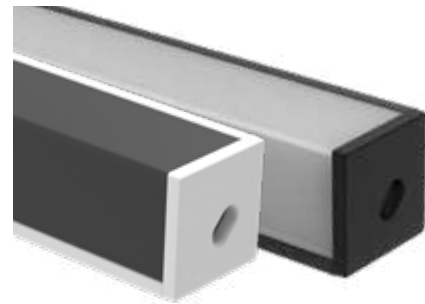

Aufbauprofil MIDI CORNER für LED Flexbänder bis Breite 8mm  
**HINWEIS:** für LED Bänder bis max. 9 Watt

Surface profile MIDI CORNER for flexible LED stripes up to width 8mm  
**INFO:** for LED stripes up to: 9 Watt

## MIDI CORNER AUFBAU/MIDI CORNER SURFACE

ART. NR./CODE	INFO	DETAIL/DETAIL	L x B x H / L x W x H	FARBE/COLOUR	PREIS/PRICE
600-a207w	Profil/Profile		2000 x 16 x 16	□ white	19,00
600-a207b	Profil/Profile		2000 x 16 x 16	■ black	16,00
600-a207s	Profil/Profile		2000 x 16 x 16	■ alu anodized	16,00
	INFO	DETAIL/DETAIL	MATERIAL/MATERIAL	FARBE/COLOUR	PREIS/PRICE
600-aek207w	Endkappen (2 Stk.)/End Piece (2 pcs.)		Kunststoff/plastic	□ white	1,60
600-aek207b	Endkappen (2 Stk.)/End Piece (2 pcs.)		Kunststoff/plastic	■ black	1,60
600-aek207s	Endkappen (2 Stk.)/End Piece (2 pcs.)		Kunststoff/plastic	■ grey	1,60
600-c207	Abdeckung/Cover		PMMA Weiß opal/PMMA white opal	□ white opal	9,00
600-cb207	Abdeckung/Cover		PMMA Schwarz opal/PMMA black opal	■ black opal	9,00
600-amc207	Montageclips (2 Stk.)/ Mounting Clips (2 pcs.)		Edelstahl/Stainless Steel	■ stainless steel	1,90

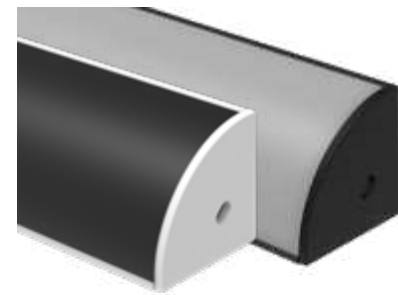

Aufbauprofil MAXI CORNER für LED Flexbänder bis Breite 15mm  
**HINWEIS:** für LED Bänder bis max. 28 Watt

Surface profile MAXI CORNER for flexible LED stripes up to width 15mm  
**INFO:** for LED stripes up to: 28 Watt

## MAXI CORNER AUFBAU/MAXI CORNER SURFACE

ART. NR./CODE	INFO	DETAIL/DETAIL	L x B x H / L x W x H	FARBE/COLOUR	PREIS/PRICE
600-a208w	Profil/Profile		2000 x 30 x 30	□ white	27,50
600-a208b	Profil/Profile		2000 x 30 x 30	■ black	25,00
600-a208s	Profil/Profile		2000 x 30 x 30	■ alu anodized	25,00
	INFO	DETAIL/DETAIL	MATERIAL/MATERIAL	FARBE/COLOUR	PREIS/PRICE
600-aekr208w	Endkappen (2 Stk.)/End Piece (2 pcs.)		Kunststoff/plastic	□ white	2,30
600-aekr208b	Endkappen (2 Stk.)/End Piece (2 pcs.)		Kunststoff/plastic	■ black	2,10
600-aekr208s	Endkappen (2 Stk.)/End Piece (2 pcs.)		Kunststoff/plastic	■ grey	2,10
600-cr208	Abdeckung/Cover		PMMA Weiß opal/PMMA white opal	□ white opal	18,00
600-crb208	Abdeckung/Cover		PMMA Schwarz opal/PMMA black opal	■ black opal	19,00
600-amc208	Montageclips (2 Stk.)/ Mounting Clips (2 pcs.)		Edelstahl/Stainless Steel	■ stainless steel	2,60

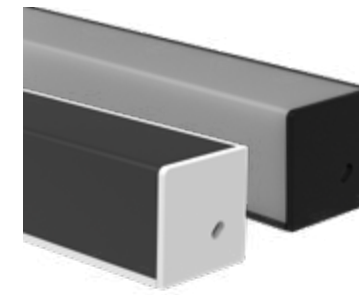

Aufbauprofil MAXI CORNER für LED Flexbänder bis Breite 15mm  
**HINWEIS:** für LED Bänder bis max. 28 Watt

Surface profile MAXI CORNER for flexible LED stripes up to width 15mm  
**INFO:** for LED stripes up to: 28 Watt

## MAXI CORNER AUFBAU/MAXI CORNER SURFACE

ART. NR./CODE	INFO	DETAIL/DETAIL	L x B x H / L x W x H	FARBE/COLOUR	PREIS/PRICE
600-a208w	Profil/Profile		2000 x 30 x 30	□ white	27,50
600-a208b	Profil/Profile		2000 x 30 x 30	■ black	25,00
600-a208s	Profil/Profile		2000 x 30 x 30	■ alu anodized	25,00
	INFO	DETAIL/DETAIL	MATERIAL/MATERIAL	FARBE/COLOUR	PREIS/PRICE
600-aek208w	Endkappen (2 Stk.)/End Piece (2 pcs.)		Kunststoff/plastic	□ white	2,10
600-aek208b	Endkappen (2 Stk.)/End Piece (2 pcs.)		Kunststoff/plastic	■ black	2,10
600-aek208s	Endkappen (2 Stk.)/End Piece (2 pcs.)		Kunststoff/plastic	■ grey	2,10
600-c208	Abdeckung/Cover		PMMA Weiß opal/PMMA white opal	□ white opal	18,00
600-cb208	Abdeckung/Cover		PMMA Schwarz opal/PMMA black opal	■ black opal	19,00
600-amc208	Montageclips (2 Stk.)/ Mounting Clips (2 pcs.)		Edelstahl/Stainless Steel	■ stainless steel	2,60





## AUFBAUPROFILE AUS ALUMINIUM/SURFACE ALUMINIUM PROFILES

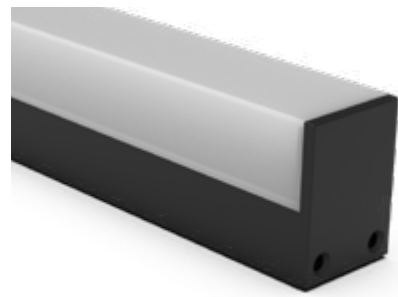

Aufbauprofil MIDI CUBE für LED Flexbänder bis Breite 12mm,  
**HINWEIS:** für LED Bänder bis max. 15 Watt

Surface profile MIDI CUBE for flexible LED stripes up to width 12mm,  
**INFO:** for LED Stripes up to: 15 Watt

## MIDI CUBE AUFBAU/MIDI CUBE SURFACE

ART. NR./CODE	INFO	DETAIL/DETAIL	L x B x H / L x W x H	FARBE/COLOUR	PREIS/PRICE
600-a211w	Profil/Profile		2000 x 20 x 27	<input type="checkbox"/> white	28,00
600-a211b	Profil/Profile		2000 x 20 x 27	<input checked="" type="checkbox"/> black	28,00
600-a211s	Profil/Profile		2000 x 20 x 27	<input checked="" type="checkbox"/> alu anodized	28,00
	INFO	DETAIL/DETAIL	MATERIAL/MATERIAL	FARBE/COLOUR	PREIS/PRICE
600-aek211w	Endkappen (2 Stk.)/End Piece (2 pcs.)		Kunststoff/plastic	<input type="checkbox"/> white	2,10
600-aek211b	Endkappen (2 Stk.)/End Piece (2 pcs.)		Kunststoff/plastic	<input checked="" type="checkbox"/> black	2,10
600-aek211s	Endkappen (2 Stk.)/End Piece (2 pcs.)		Kunststoff/plastic	<input checked="" type="checkbox"/> silver	2,10
600-c211	Abdeckung/Cover		PMMA Weiß opal/PMMA white opal	<input type="checkbox"/> white opal	11,00
600-amc211	Montageclips (2 Stk.)/Mounting Clips (2 pcs.)		Edelstahl/Stainless Steel	<input checked="" type="checkbox"/> stainless steel	2,10

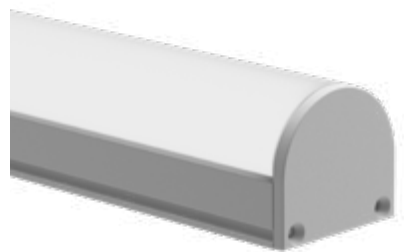

Aufbauprofil MAXI CUBE SOFT für LED Flexbänder bis Breite 18mm,  
**HINWEIS:** für LED Bänder bis max. 12 Watt

Surface profile MAXI CUBE SOFT for flexible LED stripes up to width 18mm,  
**INFO:** for LED Stripes up to: 12 Watt

## MAXI SOFT AUFBAU/MAXI SOFT SURFACE

ART. NR./CODE	INFO	DETAIL/DETAIL	L x B x H / L x W x H	FARBE/COLOUR	PREIS/PRICE
600-a210w	Profil/Profile		2000 x 26,7 x 24,4	<input type="checkbox"/> white	25,00
600-a210b	Profil/Profile		2000 x 26,7 x 24,4	<input checked="" type="checkbox"/> black	25,00
600-a210s	Profil/Profile		2000 x 26,7 x 24,4	<input checked="" type="checkbox"/> alu anodized	25,00
	INFO	DETAIL/DETAIL	MATERIAL/MATERIAL	FARBE/COLOUR	PREIS/PRICE
600-aek210w	Endkappen (2 Stk.)/End Piece (2 pcs.)		Kunststoff/plastic	<input type="checkbox"/> white	2,10
600-aek210b	Endkappen (2 Stk.)/End Piece (2 pcs.)		Kunststoff/plastic	<input checked="" type="checkbox"/> black	2,10
600-aek210s	Endkappen (2 Stk.)/End Piece (2 pcs.)		Kunststoff/plastic	<input checked="" type="checkbox"/> silver	2,10
600-c210	Abdeckung/Cover		PMMA Weiß opal/PMMA white opal	<input type="checkbox"/> white opal	10,00
600-amc210	Montageclips (2 Stk.)/Mounting Clips (2 pcs.)		Edelstahl/Stainless Steel	<input checked="" type="checkbox"/> stainless steel	2,10



Aufbauprofil FLEX für LED Flexbänder bis Breite 12mm,  
**HINWEIS:** für LED Bänder bis max. 9 Watt

Surface profile FLEX for flexible LED stripes up to width 12mm,  
**INFO:** for LED Stripes up to: 9 Watt

## FLEX AUFBAU/FLEX SURFACE

ART. NR./CODE	INFO	DETAIL/DETAIL	L x B x H / L x W x H	FARBE/COLOUR	PREIS/PRICE
600-a212s	Profil max. Biegeradius:200 mm/ Profile max. bending radius: 200 mm		2000 x 17,8 x 5,1	<input checked="" type="checkbox"/> alu anodized	15,00
	INFO	DETAIL/DETAIL	MATERIAL/MATERIAL	FARBE/COLOUR	PREIS/PRICE
600-aek212s	Endkappen (2 Stk.)/End Piece (2 pcs.)		Kunststoff/plastic	<input checked="" type="checkbox"/> silver	2,00
600-c212	Abdeckung/Cover		PMMA Weiß opal/PMMA white opal	<input type="checkbox"/> white opal	7,00
600-amc212	Montageclips (2 Stk.)/Mounting Clips (2 pcs.)		Edelstahl/Stainless Steel	<input checked="" type="checkbox"/> stainless steel	2,00





**EINBAUPROFILE AUS ALUMINIUM/RECESSED ALUMINIUM PROFILES**

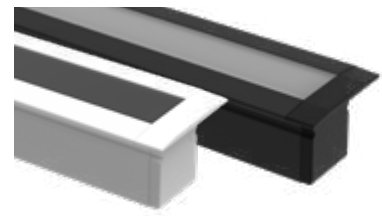

Einbauprofil MINI 10 für LED Flexbänder bis Breite 5mm  
**HINWEIS:** für LED Bänder bis max. 5 Watt, ET: 15mm, Ausschnitt: B: 12mm; Bei Verwendung von Endkappen: Profillänge + 4mm

Recessed profile MINI 10 for flexible LED stripes up to width 5mm  
**INFO:** for LED stripes up to: 5 Watt, ID: 15mm, cutout: W: 12mm; when using end caps: add +4mm to profile length



**MINI 10 EINBAU/MINI 10 RECESSED**

ART. NR./CODE	INFO	DETAIL/DETAIL	L x B x H/L x W x H	FARBE/COLOUR	PREIS/PRICE
600-1e201w	Profil/Profile		2000 x 18 x 13	<input type="checkbox"/> white	19,00
600-1e201b	Profil/Profile		2000 x 18 x 13	<input checked="" type="checkbox"/> black	19,00
600-1e201s	Profil/Profile		2000 x 18 x 13	<input checked="" type="checkbox"/> alu anodized	19,00
	INFO	DETAIL/DETAIL	MATERIAL/MATERIAL	FARBE/COLOUR	PREIS/PRICE
600-1eek201w	Endkappen (2 Stk.)/End Piece (2 pcs.)		Kunststoff/plastic	<input type="checkbox"/> white	1,60
600-1eek201b	Endkappen (2 Stk.)/End Piece (2 pcs.)		Kunststoff/plastic	<input checked="" type="checkbox"/> black	1,60
600-1eek201s	Endkappen (2 Stk.)/End Piece (2 pcs.)		Kunststoff/plastic	<input checked="" type="checkbox"/> grey	1,60
600-0c201	Abdeckung/Cover		PMMA Weiß opal/PMMA white opal	<input type="checkbox"/> white opal	5,30
600-cb201	Abdeckung/Cover		PMMA Schwarz opal/PMMA black opal	<input checked="" type="checkbox"/> black opal	7,00
600-mc201	Montageclips (2 Stk.)/Mounting Clips (2 pcs.)		Edelstahl/Stainless Steel	<input checked="" type="checkbox"/> stainless steel	1,10



Einbauprofil MINI 14 für LED Flexbänder bis Breite 8mm  
**HINWEIS:** für LED Bänder bis max. 9 Watt, ET: 15mm, Ausschnitt: B: 16mm; Bei Verwendung von Endkappen: Profillänge + 4mm

Recessed profile MINI 14 for flexible LED stripes up to width 8mm  
**INFO:** for LED stripes up to: 9 Watt, ID: 15mm, cutout: W: 16mm; when using end caps: add +4mm to profile length



**MINI 14 EINBAUBAU/MINI 14 RECESSED**

ART. NR./CODE	INFO	DETAIL/DETAIL	L x B x H/L x W x H	FARBE/COLOUR	PREIS/PRICE
600-1e202w	Profil/Profile		2000 x 22 x 13	<input type="checkbox"/> white	19,00
600-1e202b	Profil/Profile		2000 x 22 x 13	<input checked="" type="checkbox"/> black	19,00
600-1e202s	Profil/Profile		2000 x 22 x 13	<input checked="" type="checkbox"/> alu anodized	19,00
	INFO	DETAIL/DETAIL	MATERIAL/MATERIAL	FARBE/COLOUR	PREIS/PRICE
600-1eek202w	Endkappen (2 Stk.)/End Piece (2 pcs.)		Kunststoff/plastic	<input type="checkbox"/> white	1,60
600-1eek202b	Endkappen (2 Stk.)/End Piece (2 pcs.)		Kunststoff/plastic	<input checked="" type="checkbox"/> black	1,60
600-1eek202s	Endkappen (2 Stk.)/End Piece (2 pcs.)		Kunststoff/plastic	<input checked="" type="checkbox"/> grey	1,60
600-1c202	Abdeckung/Cover		PMMA Weiß opal/PMMA white opal	<input type="checkbox"/> white opal	7,00
600-cb202	Abdeckung/Cover		PMMA Schwarz opal/PMMA black opal	<input checked="" type="checkbox"/> black opal	7,00
600-emc202	Montageclips (2 Stk.)/Mounting Clips (2 pcs.)		Edelstahl/Stainless Steel	<input checked="" type="checkbox"/> stainless steel	1,10

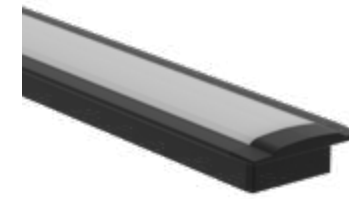

Einbauprofil MINI 17 für LED Flexbänder bis Breite 12mm  
**HINWEIS:** für LED Bänder bis max. 18 Watt, ET: 11mm, Ausschnitt: B: 19mm; Bei Verwendung von Endkappen: Profillänge + 4mm

Recessed profile MINI 17 for flexible LED stripes up to width 12mm  
**INFO:** for LED stripes up to: 18 Watt, ID: 11mm, cutout: W: 19mm; when using end caps: add +4mm to profile length



**MINI 17 EINBAU/MINI 17 RECESSED**

ART. NR./CODE	INFO	DETAIL/DETAIL	L x B x H/L x W x H	FARBE/COLOUR	PREIS/PRICE
600-e203w	Profil/Profile		2000 x 24 x 9	<input type="checkbox"/> white	19,00
600-e203b	Profil/Profile		2000 x 24 x 9	<input checked="" type="checkbox"/> black	19,00
600-e203s	Profil/Profile		2000 x 24 x 9	<input checked="" type="checkbox"/> alu anodized	19,00
	INFO	DETAIL/DETAIL	MATERIAL/MATERIAL	FARBE/COLOUR	PREIS/PRICE
600-eek203w	Endkappen (2 Stk.)/End Piece (2 pcs.)		Kunststoff/plastic	<input type="checkbox"/> white	2,10
600-eek203b	Endkappen (2 Stk.)/End Piece (2 pcs.)		Kunststoff/plastic	<input checked="" type="checkbox"/> black	2,10
600-eek203s	Endkappen (2 Stk.)/End Piece (2 pcs.)		Kunststoff/plastic	<input checked="" type="checkbox"/> grey	2,10
600-c203	Abdeckung/Cover		PMMA Weiß opal/PMMA white opal	<input type="checkbox"/> white opal	7,00
600-mc203	Montageclips (2 Stk.)/Mounting Clips (2 pcs.)		Edelstahl/Stainless Steel	<input checked="" type="checkbox"/> stainless steel	1,60

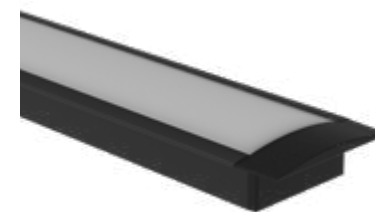

Einbauprofil MIDI für LED Flexbänder bis Breite 15mm  
**HINWEIS:** für LED Bänder bis max. 28 Watt, ET: 15mm, Ausschnitt: B: 24mm; Bei Verwendung von Endkappen: Profillänge + 4mm

Recessed profile MIDI for flexible LED stripes up to width 15mm  
**INFO:** for LED stripes up to: 28 Watt, ID: 15mm, cutout: W: 24mm; when using end caps: add +4mm to profile length



**MIDI EINBAU/MIDI RECESSED**

ART. NR./CODE	INFO	DETAIL/DETAIL	L x B x H/L x W x H	FARBE/COLOUR	PREIS/PRICE
600-e204w	Profil/Profile		2000 x 30 x 11,2	<input type="checkbox"/> white	19,00
600-e204b	Profil/Profile		2000 x 30 x 11,2	<input checked="" type="checkbox"/> black	19,00
600-e204s	Profil/Profile		2000 x 30 x 11,2	<input checked="" type="checkbox"/> alu anodized	19,00
	INFO	DETAIL/DETAIL	MATERIAL/MATERIAL	FARBE/COLOUR	PREIS/PRICE
600-eek204w	Endkappen (2 Stk.)/End Piece (2 pcs.)		Kunststoff/plastic	<input type="checkbox"/> white	2,10
600-eek204b	Endkappen (2 Stk.)/End Piece (2 pcs.)		Kunststoff/plastic	<input checked="" type="checkbox"/> black	2,10
600-eek204s	Endkappen (2 Stk.)/End Piece (2 pcs.)		Kunststoff/plastic	<input checked="" type="checkbox"/> grey	2,10
600-c204	Abdeckung/Cover		PMMA Weiß opal/PMMA white opal	<input type="checkbox"/> white opal	9,00
600-ck204	Abdeckung/Cover		PMMA klar/PMMA clear	<input type="checkbox"/> clear	9,00
600-mc204	Montageclips (2 Stk.)/Mounting Clips (2 pcs.)		Edelstahl/Stainless Steel	<input checked="" type="checkbox"/> stainless steel	1,60
600-emc204	Montageclips (2 Stk.)/Mounting Clips (2 pcs.)		Edelstahl/Stainless Steel	<input checked="" type="checkbox"/> stainless steel	7,00





### EINBAUPROFILE AUS ALUMINIUM/RECESSED ALUMINIUM PROFILES

Einbauprofil MAXI für LED Flexbänder  
bis Breite 15mm

**HINWEIS:** für LED Bänder bis max. 28  
Watt, ET: 28mm, Ausschnitt: B: 24mm;  
Bei Verwendung von Endkappen: Pro-  
fillänge + 4mm

Recessed profile MAXI for flexible LED  
stripes up to width 15mm

**INFO:** for LED stripes up to: 28 Watt, ID:  
28mm, cutout: W: 24mm;  
when using end caps:  
add +4mm to profile length



#### MAXI EINBAU/MAXI RECESSED

ART. NR./CODE	INFO	DETAIL/DETAIL	L x B x H/L x W x H	FARBE/COLOUR	PREIS/PRICE
600-e205w	Profil/Profile		2000 x 37 x 25	<input type="checkbox"/> white	29,00
600-e205b	Profil/Profile		2000 x 37 x 25	<input checked="" type="checkbox"/> black	29,00
600-e205s	Profil/Profile		2000 x 37 x 25	<input type="checkbox"/> alu anodized	35,00
	INFO	DETAIL/DETAIL	MATERIAL/MATERIAL	FARBE/COLOUR	PREIS/PRICE
600-eek205w	Endkappen (2 Stk.)/End Piece (2 pcs.)		Kunststoff/plastic	<input type="checkbox"/> white	2,60
600-eek205b	Endkappen (2 Stk.)/End Piece (2 pcs.)		Kunststoff/plastic	<input checked="" type="checkbox"/> black	2,60
600-eek205s	Endkappen (2 Stk.)/End Piece (2 pcs.)		Kunststoff/plastic	<input type="checkbox"/> grey	2,60
600-eekc205w	Endkappen (2 Stk.)/End Piece (2 pcs.)		Kunststoff/plastic	<input type="checkbox"/> white	3,20
600-eekc205b	Endkappen (2 Stk.)/End Piece (2 pcs.)		Kunststoff/plastic	<input checked="" type="checkbox"/> black	3,20
600-eekc205s	Endkappen (2 Stk.)/End Piece (2 pcs.)		Kunststoff/plastic	<input type="checkbox"/> grey	3,20
600-c205	Abdeckung flach/Cover flat		PMMA Weiß opal/PMMA white opal	<input type="checkbox"/> white opal	9,00
600-cu205	Abdeckung kubisch/Cover cubic		PMMA Weiß opal/PMMA white opal	<input type="checkbox"/> white opal	19,00
600-cb205	Abdeckung flach/Cover flat		PMMA Schwarz opal/PMMA black opal	<input checked="" type="checkbox"/> black opal	10,00
600-emc205	Montageclips (2 Stk.)/ Mounting Clips (2 pcs.)		Edelstahl/Stainless Steel	<input type="checkbox"/> stainless steel	7,00



#### ZUBEHÖR/ACCESSOIRES

ART. NR./CODE	INFO	L x B x H/L x W x H	FARBE/COLOUR	PREIS/PRICE
600-1000	Alustreifen	1000 x 10 x 3	<input type="checkbox"/> alu nature	6,00
600-1000b	Alustreifen mit Bohrungen	1000 x 10 x 3	<input type="checkbox"/> alu nature	11,00
600-3000	Alustreifen	3000 x 10 x 3	<input type="checkbox"/> alu nature	17,00
600-3000b	Alustreifen mit Bohrungen	3000 x 10 x 3	<input type="checkbox"/> alu nature	29,00

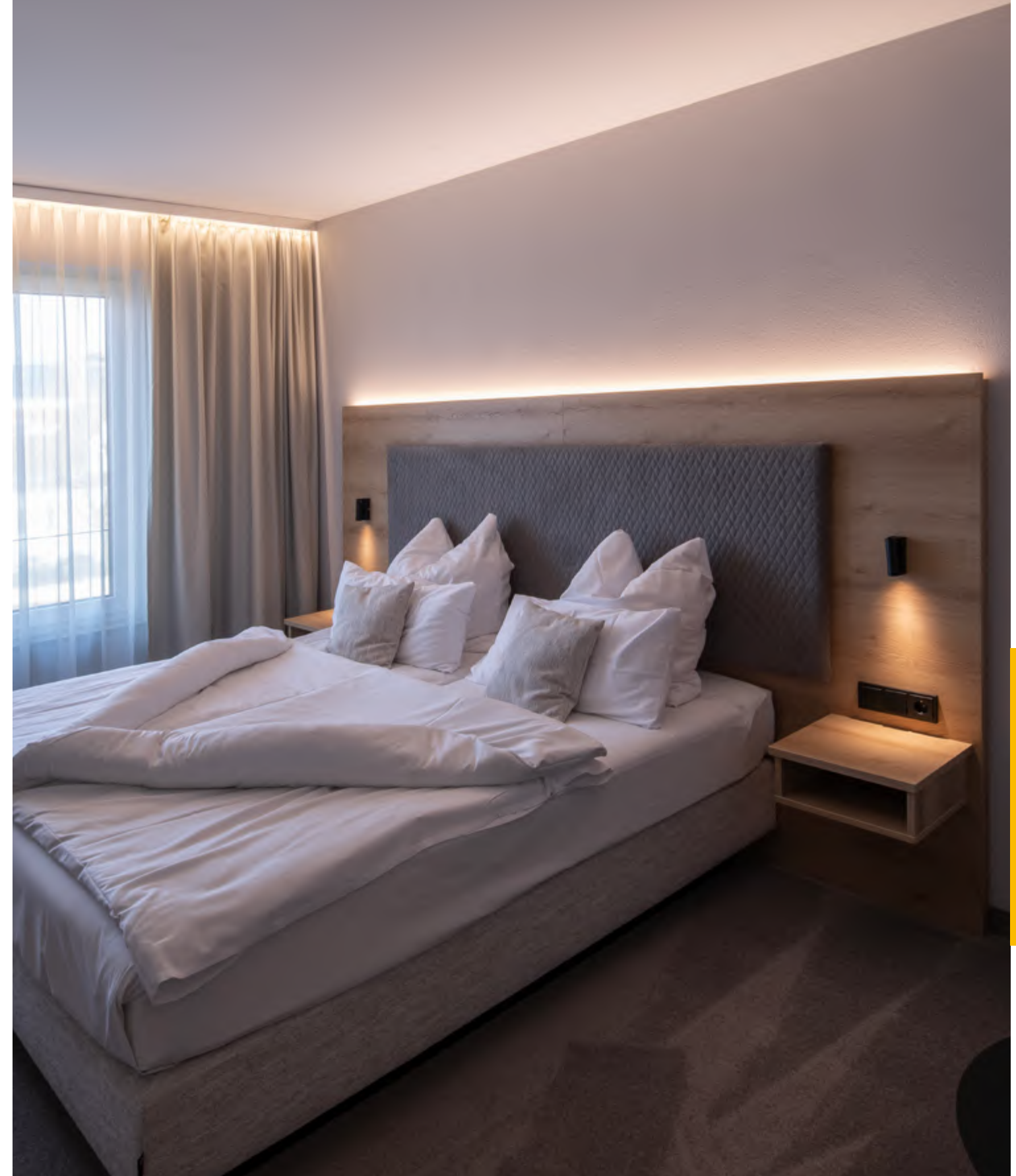



STEUERUNGEN, NETZGERÄTE  
CONTROLS, DRIVERS





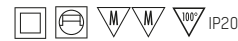

## KONVERTER SLIM/U/DRIVER SLIM/U

ART. NR./CODE	INFO	W	V DC	LxBxH/IDxLxWxH	FARBE/COLOUR	PREIS/PRICE
24-141122	Konverter für Strips, nicht dimmbar, 230 V AC/ driver for Strips, not dimmable, 230 V AC	13	24	158 x 22 x 19	□ white	28,00

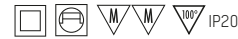

## KONVERTER EFU/DRIVER EFU

ART. NR./CODE	INFO	W	V DC	LxBxH/LxWxH	FARBE/COLOUR	PREIS/PRICE
24-141126	Konverter für Strips, nicht dimmbar, 230 V AC/ driver for Strips, not dimmable, 230 V AC	25	24	146 x 55 x 19	□ white	24,50



## KONVERTER VPS LP/DRIVER VPS LP

ART. NR./CODE	INFO	W	V DC	LxBxH/LxWxH	FARBE/COLOUR	PREIS/PRICE
24-127903	Konverter für Strips, nicht dimmbar, 230 V AC/ driver for Strips, not dimmable, 230 V AC	50	24	167 x 59 x 28,5	□ white	64,60
24-127905		75	24	184 x 61 x 28,5	□ white	81,50



## KONVERTER LCV/DRIVER LCV

ART. NR./CODE	INFO	W	V DC	V AC	LxBxH/LxWxH	FARBE/COLOUR	PREIS/PRICE
24-127821	Konverter für Strips, nicht dimmbar, 230 V AC, schaltbar/ driver for Strips, not dimmable, 230 V AC, switchable	60	24	230	180 x 52 x 30	□ white	29,70
24-127824		120	24	230	300 x 40 x 30	□ white	41,30



## KONVERTER ST2 IP67/DRIVER ST2 IP67

ART. NR./CODE	INFO	W	V DC	LxBxH/LxWxH	FARBE/COLOUR	PREIS/PRICE
24-122479	Konverter für Strips, nicht dimmbar, 230 V AC/ driver for Strips, not dimmable, 230 V AC	70	24	225 x 66 x 51	■ black	141,90
24-122511		150	24	225 x 66 x 51	■ black	301,80



## KONVERTER DC 50W 48V VST/DRIVER DC 50W 48V VST

ART. NR./CODE	INFO	W	V DC	V AC	LxBxH/LxWxH	FARBE/COLOUR	PREIS/PRICE
24-122766	nicht dimmbar/ not dimmable	50	48	230	225 x 60 x 49	□ white	66,70



## KONVERTER DC 150W 48V VST/DRIVER DC 150W 48V VST

ART. NR./CODE	INFO	W	V DC	V AC	LxBxH/LxWxH	FARBE/COLOUR	PREIS/PRICE
24-122764	nicht dimmbar/ not dimmable	150	48	230	240 x 60 x 49	□ white	141,90



## KONVERTER VST/DRIVER VST

ART. NR./CODE	INFO	W	V DC	LxBxH/LxWxH	FARBE/COLOUR	PREIS/PRICE
24-122752	Konverter für Stripes, nicht dimmbar 230V AC/ driver for stripes, not dimmable 230V AC	50	24	225 x 60 x 36	□ white	68,80
24-122750		70	24	225 x 60 x 36	□ white	76,20
24-122754n		150	24	240 x 60 x 49	■ black	103,80



**KONSTANTSPANNUNGSKONVERTER DIMMBAR/CONSTANT VOLTAGE DRIVER DIMMABLE**

**KONVERTER VSTR 1-10V PUSH IR/DRIVER VSTR 1-10V PUSH IR**

ART. NR./CODE	INFO	W	V DC	LxBxH/LxWxH	FARBE/COLOUR	PREIS/PRICE
24-122730	Konverter für Strips, dimmbar 1-10V & Push Dimm., IR-Zubehör separat ordern (IR-Empfänger inkl. 2m Kabel 24-122093 + IR-Fernbedienung 24-150120A)/ driver for Strips, dimmable 1-10V & Push dimm., order IR accessory separately (IR receiver incl. 2m cable 24-122093 + IR remote control 24-150120A)	3x 40 (RGB) 1x 100 white	24	240 x 60 x 49	□ white	217,10

**KONVERTER QT DALI/DRIVER QT DALI**

ART. NR./CODE	INFO	W	V DC	V AC	LxBxH/LxWxH	FARBE/COLOUR	PREIS/PRICE
28-177900	Konverter für Stripes DALI dimmbar, 230V AC/ driver for Stripes DALI dimmable, 230V AC	50	24	230	346 x 32 x 22	□ white	125,00
28-177924		80	24	230	346 x 32 x 22	□ white	161,00

**KONVERTER DALI PUSH/DRIVER DALI PUSH**

ART. NR./CODE	INFO	W	V DC	V AC	LxBxH/LxWxH	FARBE/COLOUR	PREIS/PRICE
711-241501dt6	Konverter für Stripes, dimmbar DALI Push Dimm. 1 KANAL/ driver for Stripes, dimmable DALI Push dimm. 1 CHANNEL	150	24	230	365 x 43 x 30	□ white	244,60

**KONVERTER DALI DT8 PUSH/DRIVER DALI DT8 PUSH**

ART. NR./CODE	INFO	W	V DC	V AC	LxBxH/LxWxH	FARBE/COLOUR	PREIS/PRICE
711-24752dt8	Konverter für Stripes, dimmbar DALI DT8 Push Dimm. 2 KANAL/ driver for Stripes, dimmable DALI DT8 Push dimm. 2 CHANNEL	75	24	230	486 x 31 x 31	■ graphite	184,30

**KONVERTER DALI PUSH/DRIVER DALI PUSH**

ART. NR./CODE	INFO	W	V DC	V AC	LxBxH/LxWxH	FARBE/COLOUR	PREIS/PRICE
711-24302dt6	Konverter für Stripes, dimmbar DALI Push Dimm. 2 KANAL/ driver for Stripes, dimmable DALI Push dimm. 2 CHANNEL	30	24	230	170 x 54 x 54	□ white	97,40

**DALI REPEATER SO DALI STEUERGERÄT/DALI REPEATER SO DALI CONTROLLER**

ART. NR./CODE	INFO	LxBxH/LxWxH	PREIS/PRICE
28-292599	DALI Signalverstärker (Repeater); Erweiterung von DALI Anlagen um jeweils 64 EVG, die an den Repeater angeschlossenen EVG arbeiten als Gruppe Touch DIM Steuerung von jeweils 64 DALI EVG (ohne integrierten Lastkontakt) für Leuchteneinbau/ DALI signal amplifier (repeater); Extension of DALI systems by 64 ECGs each; The ECGs connected to the repeater operate as a group Touch DIM control of 64 DALI ECGs each (without integrated load contact) for luminaire installation	189 x 30 x 21	225,60

**DALI REPEATER SO DALI STEUERGERÄT/DALI REPEATER SO DALI CONTROLLER**

ART. NR./CODE	INFO	LxBxH/LxWxH	PREIS/PRICE
28-301093	DALI-Signalverstärker / Steuergerät mit TOUCH-DIMM, Eingang für max. 64 DALI EVG, Ansteuerung mit jedem handelsüblichen Taster, der DALI-Ausgang erlaubt die Ansteuerung von OSRAM fremden DALI-EVG's (Philips, Tridonic usw.), mit TOUCH-DIMM Funktion, 230V, 50-60Hz/ DALI signal amplifier / control unit with TOUCH-DIMM, input for max. 64 DALI ECGs, control with any commercially available pushbutton, the DALI output allows control of third-party OSRAM DALI ECGs (Philips, Tridonic etc.), with TOUCH-DIMM function, 230V, 50-60Hz	72 x 96 x 62	271,10





IP20



### DALI MCU TW G2 STEUERGERÄT/DALI MCU TW G2 CONTROLLER

ART. NR./CODE	INFO	L x B x H/L x W x H	BLLENDE B x H/COVER W x H	PREIS/PRICE
28-224673	DALI MCU Drehregler für max. 25 DALI EVG's, ermöglicht manuelles Dimmen über DALI und Steuerung der Farbtemperatur mittels DALI DT8 tunable white, bis zu 4 DALI MCU sind parallel verwendbar, Kompatibel mit Abdeckungen von Jung, Berker, Siemens, Gira und Schneider Electric - für genauere Informationen benutzen Sie bitte den aktuellen OSRAM Katalog oder Montageanleitung, 230V / 50-60Hz, inkl. Blende (81x81mm) cremeweiß/ DALI MCU rotary controller for max. 25 DALI ECGs, enables manual dimming via DALI and control of colour temperature via DALI DT8 tunable white, up to 4 DALI MCU can be used in parallel, compatible with covers from Jung, Berker, Siemens, Gira and Schneider Electric - for more detailed information please use the current OSRAM catalogue or installation instructions, 230V / 50-60Hz, incl. cover (81x81mm) cream white	71 x 71 x 50	81 x 81	152,50



IP20



### DALI PCU STEUERGERÄT/DALI PCU CONTROLLER

ART. NR./CODE	INFO	L x B x H/L x W x H	PREIS/PRICE
28-631625	DALI PCU Steuergerät (Eingang Taster / Ausgang DALI für 25 DALI Geräte) für Einbau in UP-Dose/ DALI PCU controller (input pushbutton / output DALI for 25 DALI units) for installation in flush-mounted box	49 x 48 x 22	174,00



IP20



### DALIECO CONTROL STEUERGERÄT/DALIECO CONTROL CONTROLLER

ART. NR./CODE	INFO	L x B x H/L x W x H	PREIS/PRICE
28-988645	2-Kanal-Lichtsteuergerät mit DALI-Schnittstelle; Anschluss für bis zu 32 elektronische Vorschaltgeräte möglich Ausgänge mit elektronisch reversiblen Übertemperatur-, Kurzschluss-, Überlastschutz/ 2-CHANNEL-lightcontroller with DALI interface; connection for up to 32 electronic ballasts possible Outputs with electronic reversible overtemperature, short-circuit and overload protection	118 x 30 x 21	68,80

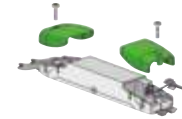

IP20



### DALIECO CI KIT/DALIECO CI KIT

ART. NR./CODE	INFO	PREIS/PRICE
28-392091	Zugentlastungskit für DALIECO CONTROL Steuergerät notwendig bei externer Montage von Steuergerät DALIECO CONTROL (Deckeneinbau)/ Strain relief kit for DALIECO controller required for external mounting of controller DALIECO control (ceiling mounting)	18,00



IP20



### DALIECO LS PD LI/DALIECO LS PD LI

ART. NR./CODE	INFO	L x B x H/L x W x H	PREIS/PRICE
28-988645	Licht- & Präsenzsensoren für Arbeitsplätze; Präsenzerfassung über passives IR-Element, Präsenzerfassungsbereich über integrierte Shutter zwischen 40...90° einstellbar, Funktionsanzeige mit zweifarbigem, Integrierter Infrarot-Fernbedienungs-Empfänger; maximale Installationshöhe 5m, für externe Montage Zubehör separat bestellen/ Light & Presence Sensor for Workplaces Presence detection via passive IR element, presence detection range via integrated shutter between 40...90° Adjustable, radiation display with two-colour, integrated infrared remote control receiver; maximum installation height 5m, for external mounting order accessories separately	48 x 15 x 17	68,80

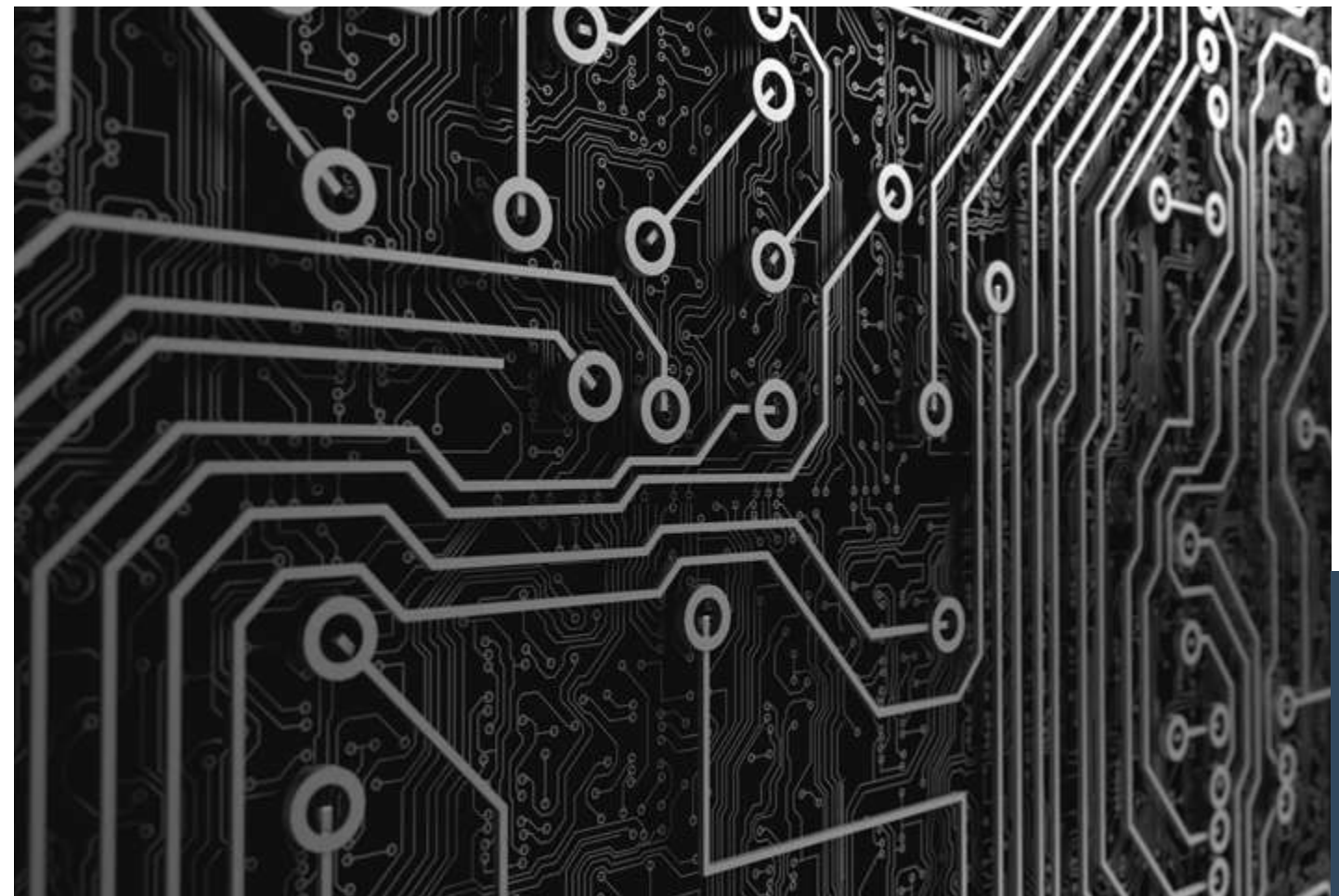



**DALIECO DECKENEINBAUADAPTER/DALIECO CEILING MOUNTING ADAPTER**



ART. NR./CODE	INFO	L x B x H/L x W x H	PREIS/PRICE
28-920293	Deckeneinbauadapter für DALIECO Sensoren [LS/PD]/ Ceiling installation adapter for DALIECO sensors [LS/PD]	80 x 36 x 68	45,50

**DALIECO DECKENAUFBAUGEHÄUSE/DALIECO CEILING MOUNTING HOUSING**

ART. NR./CODE	INFO	L x B x H/L x W x H	PREIS/PRICE
28-173385	Aufbaugeschütz für DALIECO Sensoren [LS/PD]/ Surface-mounted housing for DALIECO sensors [LS/PD]	65 x 65 x 34	53,00

**DALIECO REMOTE KIT MASTER/DALIECO REMOTE KIT MASTER**

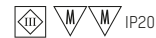
ART. NR./CODE	INFO	L x B x H/L x W x H	PREIS/PRICE
28-195967	Fernbedienung [Master] für die Konfiguration und Inbetriebnahme des DALIECO Lichtsteuerungssystems; Digitale IR-Übertragung mit Reichweite bis 10m, s zur Anzeige von Betriebs- und Programmiermodus und Signalübertragung, mit PC-Schnittstelle; im Lieferprogramm sind enthalten: Fernbedienung, 2 Stück Knopfzellen Typ CR2032, USB Verbindungskabel, DALIECO PC Software/ Remote control [Master] for configuration and commissioning of the DALIECO lighting control system; digital IR transmission with range up to 10m, s for display of operating and programming mode and signal transmission, with PC interface; included in delivery: Remote control, 2 button cells type CR2032, USB connection cable, DALIECO PC software.	230 x 45 x 13	206,50

**DMX RGBW DIMMER/DMX RGBW DIMMER**

ART. NR./CODE	INFO	V DC	L x B x H/L x W x H	FARBE/COLOUR	PREIS/PRICE
711-000705	RGBW Dimmer 12-36V DMX, 12V - 36V DC, geeignet zur Steuerung von RGBW Stripes, max. 5A / Kanal/ RGBW dimmer 12-36V DMX, 12V - 36V DC, suitable for controlling RGBW strips, max. 5A / channel	12-36	178 x 46 x 19	white	129,20

**UNIVERSALDIMMER/UNIVERSALDIMMER**

ART. NR./CODE	INFO	V DC	L x B x H/L x W x H	FARBE/COLOUR	PREIS/PRICE
322-ud3000	Universal dimmer 1 Kanal, separater Steuereingang für DALI, 1-10V, Push, Sync Anschluß für bis zu 9 Slaves bei 1-10V oder Push-Ansteuerung, max. Anschluß: 5A Zugentlastung separat ordern ZUGENTLASTUNG für 1-Kanal Universal dimmer, 2 Stück/ Universal dimmer 1 channel, separate control input for DALI, 1-10V, Push, Sync connection for up to 9 slaves with 1-10V or Push control, max. connection: 5A Strain relief to be ordered separately STAIN RELIEF for 1-channel universal dimmer, 2 pcs.	15-50	153 x 30 x 21	white	123,00
322-ud7001					12,70

**DALI DT8 PUSH DIMMER - 4 KANAL/DALI DT8 PUSH DIMMER - 4 CHANNEL**

ART. NR./CODE	INFO	W	VDC	VAC	L x B x H/L x W x H	FARBE/COLOUR	PREIS/PRICE
711-24180dt8	Dimmer für Stripes, DALI DT8 für RGB/W, Konverter separat ordern/ Dimmer for Stripes, DALI DT8 for RGB/W, order driver separately	60-180	12-36	230	170 x 54 x 28	white	170,50

**DALI DT8 RGBW - TOUCHPANEL/DALI DT8 RGBW - TOUCHPANEL**

ART. NR./CODE	INFO	VAC	L x B x H/L x W x H	FARBE/COLOUR	PREIS/PRICE
711-01230d8rgbw	Lichtszenenkontroller DALI DT8 für RGB/W Stripes, 4 Szenen konfigurierbar, zur Montage in Standard-Einbaudose Ø 68mm/ DALI DT8 light scene controller for RGB/W strips, 4 scenes configurable, for mounting in standard recessed box Ø 68mm	230	86 x 86 x 41	white	177,90

**DALI DT8 TUNABLE WHITE - TOUCHPANEL/DALI DT8 TUNABLE WHITE - TOUCHPANEL**

ART. NR./CODE	INFO	VAC	L x B x H/L x W x H	FARBE/COLOUR	PREIS/PRICE
711-01230d8tw	Lichtszenenkontroller DALI DT8 für tunable white Stripes, 4 Szenen konfigurierbar, zur Montage in Standard-Einbaudose Ø 68mm/ DALI DT8 light scene controller for tunable white strips, 4 scenes configurable, for mounting in standard recessed box Ø 68mm	230	86 x 86 x 41	white	177,90

**FUNK-STEUERUNG/RADIO CONTROLLER**

**LICHTSZENENKONTROLLER - TOUCHPANEL/LIGHT SCENES CONTROLLER**

ART. NR./CODE	INFO	FÜR/FOR	VDC	B x H x T/W x H x D	FARBE/COLOUR	PREIS/PRICE
711-000806	RGBW Funk Controller für bis zu 4 Zonen, bis zu 4 Stimmungen, Geschwindigkeit und Helligkeit kann angepasst werden, Steuereinheit kann auf Standard EB-Dose 68mm montiert werden/ RGBW radio controller for up to 4 zones, up to 4 moods, speed and brightness can be adjusted, control unit can be mounted on standard EB box 68mm	DMX	12-24	86 x 86 x 10	black	176,90
711-000606		WIFI/FUNK/RADIO	12-24	86 x 86 x 10	black	147,20





IP20

## FUNK-STEUERUNG/RADIO CONTROLLER

## WLAN GATEWAY/WLAN GATEWAY



ART. NR./CODE	INFO	V DC	B x H x T/W x H x D	FARBE/COLOUR	PREIS/PRICE
711-000406	WLAN Gateway, zur Ansteuerung von 711-000305, dazugehöriges App. EASYColor Pro im Appstore bzw. Playstore kostenlos erhältlich, Integration in hauseigenes WLAN möglich/ WLAN gateway, for controlling 711-000305, associated app. EASYColor Pro available free of charge in the Appstore or Playstore, integration into the in-house WLAN possible.	12-24	110 x 85 x 24,2	black	129,20



IP20

## RGB FUNKDIMMERFUNK FERNBEDIENUNG/RGBW RADIO DIMMER



ART. NR./CODE	INFO	W	V DC	L x B x H/L x W x H	FARBE/COLOUR	PREIS/PRICE
711-000305	4-Kanal Funk Dimmer zur Ansteuerung von RGBW, RGB oder weißen Stripes max. 5A/Kanal, Spannungsversorgung separat ordern/ 4-channel radio dimmer for controlling RGBW, RGB or white strips max. 5A/CHANNEL, order power supply separately	240-720	12-36	140 x 48 x 16	white	162,00



## FUNK FERNBEDIENUNG/RADIO REMOTE CONTROL



ART. NR./CODE	INFO	L x B x H/L x W x H	FARBE/COLOUR	PREIS/PRICE
711-000506	Funk Fernbedienung für bis zu 4 Zonen, bis zu 4 Stimmungen, Geschwindigkeit und Helligkeit kann angepasst werden, inkl. Wandhalterung/ Radio remote control for up to 4 zones, up to 4 moods, speed and brightness can be adjusted, incl. wall bracket	140 x 48 x 16	black	166,30



## FUNK FERNBEDIENUNG/RADIO REMOTE CONTROL



ART. NR./CODE	INFO	L x B x H/L x W x H	FARBE/COLOUR	PREIS/PRICE
711-001106	Funk Fernbedienung mit Farbrad zur einfachen Tunable White Steuerung, 2 Lichtfarben können gespeichert werden, 2 Szenen-Wahl, Dimmstufen in 25% Schritten abrufbar/ Radio remote control with colour wheel for easy tunable white control, 2 light colours can be stored, 2 scene selection, dimming levels can be called up in 25% steps	120 x 48 x 18	white	53,00



## FUNK FERNBEDIENUNG/RADIO REMOTE CONTROL



ART. NR./CODE	INFO	L x B x H/L x W x H	FARBE/COLOUR	PREIS/PRICE
711-000906	Funk Fernbedienung für bis zu 5 Zonen zur Dimmung der Helligkeit, Fernbedienung kann mit bis zu 8 verschiedenen Empfängern arbeiten/ Radio remote control for up to 5 zones for dimming the brightness, remote control can work with up to 8 different receivers	136 x 39 x 11	black	47,70



IP20

## FUNK DIMMER TUNABLE WHITE/RADIO DIMMER TUNABLE WHITE

277



ART. NR./CODE	INFO	W	V DC	L x B x H/L x W x H	FARBE/COLOUR	PREIS/PRICE
711-001005	2-Kanal Funk Dimmer zur Ansteuerung von Tunable White Stripes max. 5A/Kanal, Spannungsversorgung separat ordern/ 2-channel radio dimmer for controlling Tunable White LED strips max. 5A/channel, order power supply separately	110-240	12-24	145 x 47 x 16	white	60,40



## BLUETOOTHSTEUERUNG/BLUETOOTH CONTROLLER



## PUSH BUTTON INTERFACE/PUSH BUTTON INTERFACE

ART. NR./CODE	INFO	V AC	L x B x H/L x W x H	FARBE/COLOUR	PREIS/PRICE
701-1005	Zur Integration von handelsüblichen Tastern in die MOLTO LUCE Smart App BLUETOOTH Dimm., 3 Kanal UP-Dosenmodul/ For integrating commercially available push-buttons into the MOLTO LUCE Smart App., BLUETOOTH Dimm., 3 channel flush-mounted box module.	230	43 x 43 x 18	blue	111,20



IP20

## BLUETOOTH DIMMER-2 KANAL/BLUETOOTH DIMMER-2 CHANNEL



ART. NR./CODE	INFO	W	V DC OUT	L x B x H/L x W x H	FARBE/COLOUR	PREIS/PRICE
701-1004	SED DCC 2CH BLL Konverter, PWM-dimmbar, Draht Querschnitt bis zu 2,5mm, Schutz gegen Überhitzung und Kurzschluss, Netzüber- spannungen, Überlast, Deckeneinlegeausschnitt=40mm, I out = 4,5A max./ SED DCC 2CH BLL converter, PWM-dimmable, wire cross-section up to 2.5mm, protection against overheating and short-circuit, mains overvoltage, overload, ceiling cut-out=40mm, I out = 4.5A max.	2x 55 1x 110	2x 24	115 x 34 x 19	blue	92,10



IP20

## INTERFACE SMART BLUETOOTH TO DALI/INTERFACE SMART BLUETOOTH TO DALI



ART. NR./CODE	INFO	V AC	L x B x H/L x W x H	FARBE/COLOUR	PREIS/PRICE
701-1003	Zur Integration von max. 40 Dali dimmbaren Leuchte in die MOLTO LUCE Smart App, BLUETOOTH Dimm., Smart BLUETOOTH to DALI/ For integration of max. 40 Dali dimmable luminaires in the MOLTO LUCE Smart App, BLUETOOTH Dimm., Smart BLUETOOTH to DALI	230	85 x 30 x 22	blue	81,50

## MOLTO LUCE SMART APP/MOLTO LUCE SMART APP



## INFO

Die Molto Luce Smart APP ist ihr System zur Lichtsteuerung, egal ob einzelne Gruppen, ganze Netzwerke, Szenen, Zeitsteuerungen und komplexe Lösungen wie Heatmapping. Die Molto Luce Smart APP stellt Ihnen alle Möglichkeiten zur Verfügung. **DOWNLOAD IM APP ODER PLAY STORE!**  
The Molto Luce Smart APP is your system for lighting control, whether individual groups, entire networks, scenes, time controls and complex solutions such as heat mapping. The Molto Luce Smart APP provides you with all possibilities. **DOWNLOAD IN APP OR PLAY STORE**

SMART APP BEDIENUNGSANLEITUNG:  
SMART APP INSTRUCTION MANUAL:





## TRANSFORMATOREN/TRANSFORMER

## ELEKTRONISCHER TRANSFORMATOR/ELECTRONIC TRANSFORMER

ART. NR./CODE	INFO	W	LxBxH/IDxLxWxH	FARBE/COLOUR	PREIS/PRICE
24-119654	Elektronischer Transformator, weiß, dimmbar mit Phasen-/abschnittdimmer, thermisch progressive Sicherung (NTC), gesichert gegen Kurzschluß und Überlast auf Sekundärseite, automatische Wiederherstellung, elektromagnetische Verträglichkeit, Funkenstörfilter gem. EN55014/5, Transformatorbefestigung durch Ösen und Schrauben, Klemmabdeckung mit integrierter Zugentlastung, primär 2,5mm <sup>2</sup> , sekundär bis 2,5mm <sup>2</sup> (60-105VA), bzw. bis 6mm <sup>2</sup> (150VA), * nur Phasenabschnitt dimmbar (210 und 250VA)/	10-60	94 x 31 x 20	white	15,90
24-119730	electronic transformer, white, dimmable with leading edge / trailing edge, thermal progressive fuse (NTC), protections against short circuits and against overloads on secondary side; automatic recovery, electromagnetic compatibility, radio interference filter according to EN55014/5, transformer fixing by eyelets and screws, terminal cover with integrated strain relief, primary 2,5mm <sup>2</sup> , secondary up to 2,5mm <sup>2</sup> (60-105VA) respectively up to 6mm <sup>2</sup> (150VA), only trailing edge dimmable (210 and 250VA)	20-105	128 x 38 x 28	white	16,90
24-119851u		30-150	166 x 47 x 35	white	30,70



## ELEKTRONISCHER TRANSFORMATOR/ELECTRONIC TRANSFORMER

ART. NR./CODE	INFO	W	LxBxH/IDxLxWxH	FARBE/COLOUR	PREIS/PRICE
75-pr105	Elektronischer Transformator, schwarz, vergossen, dimmbar mit Phasenabschnittdimmer, thermisch progressive Sicherung gesichert gegen Kurzschluß und Überlast auf Sekundärseite, elektromagnetische Verträglichkeit, Funkenstörfilter gem. EN55014/5, Anschluß mit Litzekabel Länge 200mm, Primärleitung 2x 0,75mm <sup>2</sup> doppelt isoliert, Sekundärleitung 2x 0,75mm <sup>2</sup> , Umgebungstemperatur -10° bis +40°/ electronic transformer, black, spilled, dimmable with trailing edge, thermal progressive fuse (NTC), protections against short circuits and against overloads on secondary side; electromagnetic compatibility, radio interference filter according to EN55014/5, connection with stranded wire length 200mm, primary line 2x 0,75mm <sup>2</sup> , double isolated, secondary line 2x 0,75mm <sup>2</sup> , ambient temperature -10° up to +40°	20-105	134 x 30 x 21	black	26,50



## ELEKTRONISCHER TRANSFORMATOR/ELECTRONIC TRANSFORMER

ART. NR./CODE	INFO	W	Ø x H/Ø x H	FARBE/COLOUR	PREIS/PRICE
24-119640	Elektronischer Transformator, weiß, rund, dimmbar mit Phasen-/ abschnittdimmer, thermisch progressive Sicherung (NTC) gesichert gegen Kurzschluß und Überlast auf Sekundärseite, Wiederherstellung automatisch, elektromagnetische Verträglichkeit, Funkenstörfilter gem. EN55014/5, Ausgangsspannung 12V/	20-60	53 x 19	white	18,00
24-119618	electronic transformer, white, round, dimmable with leading edge / trailing edge, thermal progressive fuse (NTC), protections against short circuits and against overloads on secondary side; automatic recovery, electromagnetic compatibility, radio interference filter according to EN55014/5, output voltage 12V	20-105	70 x 22	white	26,50

## KONSTANTSTROM KONVERTER/CONSTANT CURRENT DRIVER



## KONVERTER STM U/DRIVER STM U

ART. NR./CODE	INFO	W	mA	V DC	LxBxH/LxWxH	FARBE/COLOUR	PREIS/PRICE
24-127719	nicht dimmbar, 230V/ not dimmable, 230V	6	250	23	42 x 40 x 22	black	19,80
24-127715		8	350	23	42 x 40 x 22	black	19,80
24-127717		6	500	9	42 x 40 x 22	black	19,80
24-127718		6	700	12	42 x 40 x 22	black	19,80



## KONVERTER BULL U/DRIVER BULL U

ART. NR./CODE	INFO	W	mA	V DC	LxBxH/LxWxH	FARBE/COLOUR	PREIS/PRICE
24-141133	nicht dimmbar, 230V AC/ not dimmable, 230V AC	9	250	36	60 x 35 x 21,5	white	23,30
24-141130		4	350	12	60 x 35 x 21,5	white	21,00
24-141132		8	350	22	60 x 35 x 21,5	white	21,00
24-141131		6	500	12	60 x 35 x 21,5	white	22,10



## KONVERTER STC U/DRIVER STC U

ART. NR./CODE	INFO	W	mA	V DC	LxBxH/LxWxH	FARBE/COLOUR	PREIS/PRICE
24-141050	nicht dimmbar, 230V AC/ not dimmable, 230V AC	8	350	23	51 x 31 x 21	black	17,50
24-141054		6	500	12	51 x 31 x 21	black	17,50



## KONVERTER SLIM U/DRIVER SLIM U

ART. NR./CODE	INFO	W	mA	V DC	LxBxH/LxWxH	FARBE/COLOUR	PREIS/PRICE
24-141110	nicht dimmbar, 230V AC/ not dimmable, 230V AC	15	350	43	142 x 22 x 19	white	28,00



## KONVERTER PMR/DRIVER PMR

ART. NR./CODE	INFO	W	mA	V DC	Ø x H/Ø x H	FARBE/COLOUR	PREIS/PRICE
75-pmr12	nicht dimmbar, 230V AC/ not dimmable, 230V AC	8	700	12	53 x 19	white	21,20





## KONVERTER PMR/DRIVER PMR

ART. NR./CODE	INFO	W	mA	V DC	L x B x H/L x W x H	FARBE/COLOUR	PREIS/PRICE
75-mp11	nicht dimmbar, 230V AC/ not dimmable, 230V AC	1	350	6	51 x 32 x 18	■ black	18,00
75-mp13		4	350	12	51 x 32 x 18	■ black	18,00
75-mp14		2	700	6	51 x 32 x 18	■ black	18,00
75-mp15		4	500	9	51 x 32 x 18	■ black	16,90

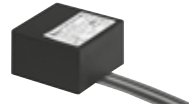

## KONVERTER STPM U IP54/DRIVER STPM U 54

ART. NR./CODE	INFO	W	mA	V DC	L x B x H/L x W x H	FARBE/COLOUR	PREIS/PRICE
24-127703	nicht dimmbar, 230V AC/ not dimmable, 230V AC	8	350	23	44 x 46 x 26,5	■ black	32,10
24-127705		8	500	12	44 x 46 x 26,5	■ black	32,10
24-127701		6	700	12	44 x 46 x 26,5	■ black	32,10

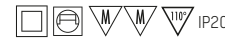

## KONVERTER MOLTO LUCE/DRIVER MOLTO LUCE

ART. NR./CODE	INFO	W	mA	V DC	L x B x H/L x W x H	FARBE/COLOUR	PREIS/PRICE		
877-BKPSL012LA0300AS	Konverter, nicht dimmbar, 230V AC, doppelter Anschlussblock für Durchgangsverdrahtung/ driver, non-dimmable, 230V AC, double terminal block for through-wiring Einstellbar mittels/Adjustable with DIP-Switch:	8-12	200-300	28-42	157,5 x 48 x 30	■ grey/white	25,00		
	<b>mA</b>							<b>W</b>	<b>V DC</b>
	200							8	28-42
	250							10	28-42
	300							12	28-42



## KONVERTER MOLTO LUCE/DRIVER MOLTO LUCE

ART. NR./CODE	INFO	W	mA	V DC	L x B x H/L x W x H	FARBE/COLOUR	PREIS/PRICE		
877-BKPSL022LA0500AS	Konverter, nicht dimmbar, 230V AC, doppelter Anschlussblock für Durchgangsverdrahtung/ driver, non-dimmable, 230V AC, double terminal block for through-wiring Einstellbar mittels/Adjustable with DIP-Switch:	12 - 21	300 - 500	28-42	157,5 x 48 x 30	■ grey/white	25,00		
	<b>mA</b>							<b>W</b>	<b>V DC</b>
	300							12	28-42
	350							14	28-42
	400							16	28-42
	450							18	28-42
	500							21	28-42



## KONVERTER XITANIUM MINI 20W/DRIVER XITANIUM MINI 20W

ART. NR./CODE	INFO	W	mA	V DC	L x B x H/L x W x H	FARBE/COLOUR	PREIS/PRICE		
30-880006	Konverter, nicht dimmbar, 230V AC, doppelter Anschlussblock für Durchgangsverdrahtung/ driver, non-dimmable, 230V AC, double terminal block for through-wiring Einstellbar mittels/Adjustable with DIP-Switch:	6-20	150-500	5-44	156 x 43 x 30	□ white	13,00		
	<b>mA</b>							<b>W</b>	<b>V DC</b>
	150							6	5-44
	200							8,5	5-44
	250							11	5-44
	300							13	5-44
	350							15	5-44
	400							17,5	5-44
	450							20	5-44
	500							18,5	5-37



## KONVERTER XITANIUM MINI 30W/DRIVER XITANIUM MINI 30W

ART. NR./CODE	INFO	W	mA	V DC	L x B x H/L x W x H	FARBE/COLOUR	PREIS/PRICE		
30-880106	Konverter, nicht dimmbar, 230V AC, doppelter Anschlussblock für Durchgangsverdrahtung/ driver, non-dimmable, 230V AC, double terminal block for through-wiring Einstellbar mittels/Adjustable with DIP-Switch:	9-30	350-700	5-44	156 x 43 x 30	□ white	14,00		
	<b>mA</b>							<b>W</b>	<b>V DC</b>
	350							15	5-44
	400							17	5-44
	450							19	5-44
	500							22	5-44
	550							24	5-44
	600							26	5-44
	650							28	5-44
	700							30	5-44



## KONVERTER XITANIUM MINI 40W/DRIVER XITANIUM MINI 40W

ART. NR./CODE	INFO	W	mA	V DC	L x B x H/L x W x H	FARBE/COLOUR	PREIS/PRICE		
30-880206	Konverter, nicht dimmbar, 230V AC, doppelter Anschlussblock für Durchgangsverdrahtung/ driver, non-dimmable, 230V AC, double terminal block for through-wiring Einstellbar mittels/Adjustable with DIP-Switch:	12 - 40	700 - 1050	5-44	156 x 43 x 30	□ white	15,00		
	<b>mA</b>							<b>W</b>	<b>V DC</b>
	700							30	5-44
	750							33	5-44
	800							35	5-44
	850							37	5-44
	900							39	5-44
	950							40	5-44
	1000							40	5-40
	1050							40	5-38





KONVERTER PROFESSIONALE IN 52/DRIVER PROFESSIONALE IN 52

ART. NR./CODE	INFO	W	mA	V DC	LxBxH/LxWxH	FARBE/COLOUR	PREIS/PRICE																																																					
24-127483	nicht dimmbar, 230V AC, doppelter Anschlussblock für Durchgangsverdrahtung/ not dimmable, 230V AC, Double terminal block for through-wiring Einstellbar mittels/Adjustable with DIP-Switch:	27,3-52	650-1400	42-37,5	132 x 79 x 30	■ grey	64,60																																																					
	<table border="1"> <thead> <tr> <th>mA</th> <th>W</th> <th>V DC</th> <th>mA</th> <th>W</th> <th>V DC</th> </tr> </thead> <tbody> <tr><td>650</td><td>27,3</td><td>42</td><td>1050</td><td>42</td><td>40</td></tr> <tr><td>700</td><td>29,4</td><td>42</td><td>1100</td><td>42,9</td><td>39</td></tr> <tr><td>750</td><td>30,7</td><td>41</td><td>1150</td><td>44,8</td><td>39</td></tr> <tr><td>800</td><td>32,8</td><td>41</td><td>1200</td><td>46,8</td><td>39</td></tr> <tr><td>850</td><td>34,8</td><td>41</td><td>1250</td><td>47,5</td><td>38</td></tr> <tr><td>900</td><td>36</td><td>40</td><td>1300</td><td>49,4</td><td>38</td></tr> <tr><td>950</td><td>38</td><td>40</td><td>1350</td><td>51,3</td><td>38</td></tr> <tr><td>1000</td><td>40</td><td>40</td><td>1400</td><td>52</td><td>37,5</td></tr> </tbody> </table>	mA	W	V DC	mA	W	V DC	650	27,3	42	1050	42	40	700	29,4	42	1100	42,9	39	750	30,7	41	1150	44,8	39	800	32,8	41	1200	46,8	39	850	34,8	41	1250	47,5	38	900	36	40	1300	49,4	38	950	38	40	1350	51,3	38	1000	40	40	1400	52	37,5					
mA	W	V DC	mA	W	V DC																																																							
650	27,3	42	1050	42	40																																																							
700	29,4	42	1100	42,9	39																																																							
750	30,7	41	1150	44,8	39																																																							
800	32,8	41	1200	46,8	39																																																							
850	34,8	41	1250	47,5	38																																																							
900	36	40	1300	49,4	38																																																							
950	38	40	1350	51,3	38																																																							
1000	40	40	1400	52	37,5																																																							



KONVERTER MP 50 K3/DRIVER MP 50 K3

ART. NR./CODE	INFO	W	mA	V DC	LxBxH/LxWxH	FARBE/COLOUR	PREIS/PRICE																																			
24-122204	nicht dimmbar, 230V AC/ not dimmable, 230V AC Einstellbar mittels/Adjustable with DIP-Switch:	25-50	350-1050	74-48	124 x 79 x 22	□ white	60,40																																			
	<table border="1"> <thead> <tr> <th>mA</th> <th>W</th> <th>V DC</th> <th>mA</th> <th>W</th> <th>V DC</th> </tr> </thead> <tbody> <tr><td>350</td><td>25</td><td>74</td><td>750</td><td>50</td><td>66</td></tr> <tr><td>500</td><td>35</td><td>72</td><td>850</td><td>50</td><td>58</td></tr> <tr><td>550</td><td>39</td><td>72</td><td>900</td><td>50</td><td>55</td></tr> <tr><td>650</td><td>46</td><td>72</td><td>1050</td><td>50</td><td>48</td></tr> <tr><td>700</td><td>50</td><td>71</td><td></td><td></td><td></td></tr> </tbody> </table>	mA	W	V DC	mA	W	V DC	350	25	74	750	50	66	500	35	72	850	50	58	550	39	72	900	50	55	650	46	72	1050	50	48	700	50	71								
mA	W	V DC	mA	W	V DC																																					
350	25	74	750	50	66																																					
500	35	72	850	50	58																																					
550	39	72	900	50	55																																					
650	46	72	1050	50	48																																					
700	50	71																																								

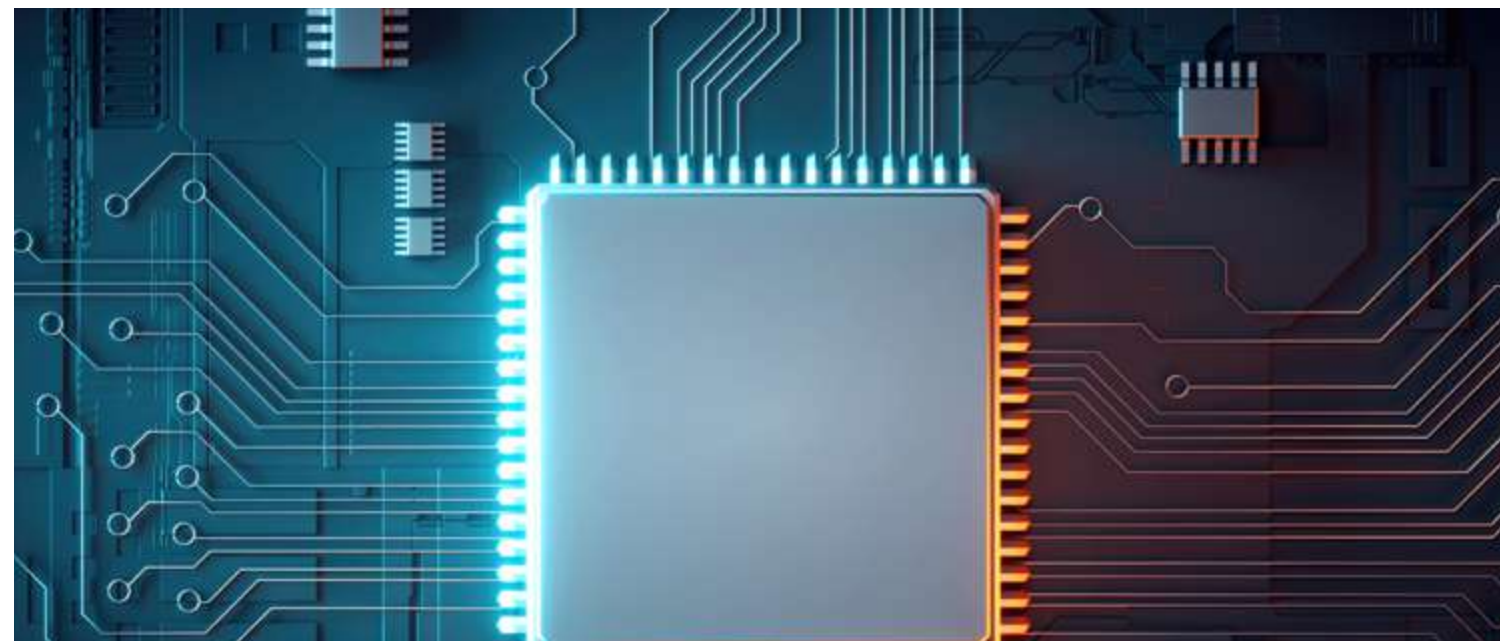

KONVERTER MINI JOLLY 20/DRIVER MINI JOLLY 20

ART. NR./CODE	INFO	W	mA	V DC	LxBxH/LxWxH	FARBE/COLOUR	PREIS/PRICE																																															
24-151400	Konverter, 1-10V & PUSH dimmbar, 230V AC/ driver, 1-10V & PUSH dimmable, 230V AC Einstellbar mittels/Adjustable with DIP-Switch: Konstantstrom/constant current	13-20	250-900	53-23	111 x 52 x 22	□ white	47,70																																															
	<table border="1"> <thead> <tr> <th>mA</th> <th>W</th> <th>V DC</th> <th>mA</th> <th>W</th> <th>V DC</th> </tr> </thead> <tbody> <tr><td>250</td><td>13</td><td>53</td><td>600</td><td>20</td><td>34</td></tr> <tr><td>300</td><td>15</td><td>52</td><td>650</td><td>20</td><td>31</td></tr> <tr><td>350</td><td>18</td><td>50</td><td>700</td><td>20</td><td>29</td></tr> <tr><td>400</td><td>20</td><td>50</td><td>750</td><td>20</td><td>27</td></tr> <tr><td>450</td><td>20</td><td>45</td><td>800</td><td>20</td><td>25</td></tr> <tr><td>500</td><td>20</td><td>40</td><td>850</td><td>20</td><td>24</td></tr> <tr><td>550</td><td>20</td><td>37</td><td>900</td><td>20</td><td>23</td></tr> </tbody> </table>	mA	W	V DC	mA	W	V DC	250	13	53	600	20	34	300	15	52	650	20	31	350	18	50	700	20	29	400	20	50	750	20	27	450	20	45	800	20	25	500	20	40	850	20	24	550	20	37	900	20	23					
mA	W	V DC	mA	W	V DC																																																	
250	13	53	600	20	34																																																	
300	15	52	650	20	31																																																	
350	18	50	700	20	29																																																	
400	20	50	750	20	27																																																	
450	20	45	800	20	25																																																	
500	20	40	850	20	24																																																	
550	20	37	900	20	23																																																	



KONVERTER MINI JOLLY LC20/DRIVER MINI JOLLY LC20

ART. NR./CODE	INFO	W	mA	V DC	LxBxH/LxWxH	FARBE/COLOUR	PREIS/PRICE																																															
24-151401	Konverter, 1-10V & PUSH dimmbar, 230V AC/ driver, 1-10V & PUSH dimmable, 230V AC Einstellbar mittels/Adjustable with DIP-Switch: Konstantstrom/constant current	5-20	100-380	54-52	111 x 52 x 22	□ white	48,70																																															
	<table border="1"> <thead> <tr> <th>mA</th> <th>W</th> <th>V DC</th> <th>mA</th> <th>W</th> <th>V DC</th> </tr> </thead> <tbody> <tr><td>100</td><td>5</td><td>54</td><td>260</td><td>14</td><td>53</td></tr> <tr><td>120</td><td>6</td><td>54</td><td>280</td><td>15</td><td>53</td></tr> <tr><td>140</td><td>7</td><td>53</td><td>300</td><td>16</td><td>52,5</td></tr> <tr><td>160</td><td>8</td><td>53</td><td>320</td><td>17</td><td>52</td></tr> <tr><td>180</td><td>9</td><td>53</td><td>340</td><td>18</td><td>52</td></tr> <tr><td>200</td><td>10</td><td>53</td><td>360</td><td>19</td><td>52</td></tr> <tr><td>240</td><td>12</td><td>53</td><td>380</td><td>20</td><td>52</td></tr> </tbody> </table>	mA	W	V DC	mA	W	V DC	100	5	54	260	14	53	120	6	54	280	15	53	140	7	53	300	16	52,5	160	8	53	320	17	52	180	9	53	340	18	52	200	10	53	360	19	52	240	12	53	380	20	52					
mA	W	V DC	mA	W	V DC																																																	
100	5	54	260	14	53																																																	
120	6	54	280	15	53																																																	
140	7	53	300	16	52,5																																																	
160	8	53	320	17	52																																																	
180	9	53	340	18	52																																																	
200	10	53	360	19	52																																																	
240	12	53	380	20	52																																																	



KONVERTER MINI JOLLY DALI 20/DRIVER MINI JOLLY DALI 20

ART. NR./CODE	INFO	W	mA	V DC	LxBxH/LxWxH	FARBE/COLOUR	PREIS/PRICE																													
24-151403	Konverter, DALI dimmbar, 230V AC/ driver, DALI dimmable, 230V AC Einstellbar mittels/Adjustable with DIP-Switch: Konstantstrom/constant current	12-20	250-700	49-28	111 x 52 x 22	□ white	57,20																													
	<table border="1"> <thead> <tr> <th>mA</th> <th>W</th> <th>V DC</th> <th>mA</th> <th>W</th> <th>V DC</th> </tr> </thead> <tbody> <tr><td>250</td><td>12</td><td>49</td><td>500</td><td>20</td><td>40</td></tr> <tr><td>350</td><td>17</td><td>49</td><td>550</td><td>20</td><td>36</td></tr> <tr><td>400</td><td>19</td><td>49</td><td>600</td><td>20</td><td>33</td></tr> <tr><td>450</td><td>20</td><td>45</td><td>700</td><td>20</td><td>28</td></tr> </tbody> </table>	mA	W	V DC	mA	W	V DC	250	12	49	500	20	40	350	17	49	550	20	36	400	19	49	600	20	33	450	20	45	700	20	28					
mA	W	V DC	mA	W	V DC																															
250	12	49	500	20	40																															
350	17	49	550	20	36																															
400	19	49	600	20	33																															
450	20	45	700	20	28																															



**KONSTANTSTROM KONVERTER DIMMBAR/CONSTANT CURRENT DRIVER DIMMABLE**

**KONVERTER MINI JOLLY LC DALI/DRIVER MINI JOLLY LC DALI**

ART. NR./CODE	INFO	W	mA	V DC	LxBxH/LxWxH	FARBE/COLOUR	PREIS/PRICE						
24-151395	Konverter, DALI dimmbar, 230V AC/ driver, DALI dimmable, 230V AC Einstellbar mittels/Adjustable with DIP-Switch: Konstantstrom/constant current	5-19	100-380	50	108 x 52 x 22	□ white	58,20						
								mA	W	V DC	mA	W	V DC
								100	5	50	260	13	50
								140	7	50	300	15	50
								180	9	50	340	17	50
								220	11	53	380	19	50

**KONVERTER PROFESSIONALE DALI 36/DRIVER PROFESSIONALE DALI 36**

ART. NR./CODE	INFO	W	mA	V DC	LxBxH/LxWxH	FARBE/COLOUR	PREIS/PRICE						
24-127490	Konverter, DALI dimmbar, 230V AC/ driver, DALI dimmable, 230V AC Einstellbar mittels/Adjustable with DIP-Switch: Konstantstrom/constant current	16-38	300-1050	54-36	147 x 44 x 30	□ white	67,80						
								mA	W	V DC	mA	W	V DC
								300	16	54	700	38	54
								350	18	54	750	38	51
								400	21	54	800	38	48
								450	24	54	850	38	45
								500	27	54	900	38	42
								550	29	54	950	38	40
								600	32	54	1000	38	38
								650	35	54	1050	38	36

**KONVERTER MAXI JOLLY SV DALI 50/DRIVER MAXI JOLLY SV DALI 50**

ART. NR./CODE	INFO	W	mA	V DC	LxBxH/LxWxH	FARBE/COLOUR	PREIS/PRICE						
24-151504	Konverter, 1-10V PUSH & DALI dimmbar, 230V AC/ driver, 1-10V PUSH & DALI dimmable, 230V AC Einstellbar mittels/Adjustable with DIP-Switch:	18-50	350-1200	53-41	124 x 79 x 22	□ white	80,50						
								mA	W	V DC	mA	W	V DC
								350	18	53	800	39	53
								400	21	53	850	42	53
								450	23	53	900	45	53
								500	2	53	950	47,	52
								550	29	53	1000	50	50
								600	31	53	1050	50	48
								650	34	53	1100	50	45
								700	34	53	1150	50	43
								750	37	53	1200	50	41

**KONSTANTSTROM KONVERTER DIMMBAR/CONSTANT CURRENT DRIVER DIMMABLE**

**KONVERTER PROFESSIONALE IN DALI 20/DRIVER PROFESSIONALE IN DALI 20**

ART. NR./CODE	INFO	W	mA	V DC	LxBxH/LxWxH	FARBE/COLOUR	PREIS/PRICE						
24-127508	Konverter, PUSH & DALI dimmbar, 230V AC, doppelte Anschluss- und DALI-Klemmblöcke für Durchgangsverdrahtung/ driver, PUSH & DALI dimmable, 230V AC, double connection and DALI terminal blocks for through-wiring Einstellbar mittels/Adjustable with DIP-Switch:	6,5-20	125-500	54-40	132 x 79 x 30	■ grey	46,60						
								mA	W	V DC	mA	W	V DC
								125	6,5	54	325	17	54
								150	8	54	350	19	54
								175	9	54	375	20	54
								200	10	54	400	20	54
								225	12	54	425	20	47
								250	13	54	450	20	44
								275	14	54	475	20	42
								300	16	54	500	20	40

**KONVERTER PROFESSIONALE IN DALI 40/DRIVER PROFESSIONALE IN DALI 40**

ART. NR./CODE	INFO	W	mA	V DC	LxBxH/LxWxH	FARBE/COLOUR	PREIS/PRICE						
24-127481	Konverter, PUSH & DALI dimmbar, 230V AC, doppelte Anschluss- und DALI-Klemmblöcke für Durchgangsverdrahtung/ driver, PUSH & DALI dimmable, 230V AC, double connection and DALI terminal blocks for through-wiring Einstellbar mittels/Adjustable with DIP-Switch:	16-40	300-1050	54-38	132 x 80 x 30	■ grey	56,10						
								mA	W	V DC	mA	W	V DC
								300	16	54	700	38	54
								350	19	54	750	40	54
								400	21	54	800	40	50
								450	24	54	850	40	47
								500	27	54	900	40	45
								550	29	54	950	40	42
								600	32	54	1000	40	40
								650	35	54	1050	40	38

**KONVERTER MOLTO LUCE DALI/DRIVER MOLTO LUCE DALI**

ART. NR./CODE	INFO	W	mA	V DC	LxBxH/LxWxH	FARBE/COLOUR	PREIS/PRICE						
877-BKDDL030B0800ADP	Konverter, PUSH & DALI-2 dimmbar, 230V AC, doppelte Anschluss- und DALI-Klemmblöcke für Durchgangsverdrahtung/ Converter, PUSH & DALI-2 dimmable, 230V AC, double connection and DALI terminal blocks for through-wiring Einstellbar mittels/Adjustable with DIP-Switch:	10,50 - 33,50	250 - 800	6-42	172 x 57,5 x 30	■ blue/black	55,00						
								mA	W	V DC	mA	W	V DC
								250	10,5	6-42	450	18	6-42
								275	11	6-42	500	21	6-42
								300	12	6-42	550	23	6-42
								325	13	6-42	600	25	6-42
								350	14	6-42	650	27	6-42
								375	15	6-42	700	29	6-42
								400	16	6-42	750	31	6-42
								425	17	6-42	800	33,5	6-42



**KONSTANTSTROM KONVERTER DIMMBAR/CONSTANT CURRENT DRIVER DIMMABLE**

**KONVERTER FÜR PANELLEUCHE FIT/DRIVER FOR PANEL LIGHT FIT**

ART. NR./CODE	INFO	AUSFÜHRUNG/EXECUTION	mA	L x B x H/ L x W x H	FARBE/COLOUR	PREIS/PRICE
757-k900s	Konverter 230V AC für Panelleuchte FIT, inkl. MOLEX Steckverbindung/ 230V AC converter for FIT panel light, incl. MOLEX plug connection	schaltbar/switchable	900	103 x 67 x 30	<input type="checkbox"/> white	<b>31,80</b>
757-k1200s		schaltbar/switchable	1200	130 x 43 x 30	<input type="checkbox"/> white	<b>42,40</b>
757-k900d		DALI dimmbar/dimmable	900	110 x 75 x 25	<input type="checkbox"/> white	<b>87,90</b>
757-k1200d		DALI dimmbar/dimmable	1200	171 x 81 x 30	<input type="checkbox"/> white	<b>97,40</b>

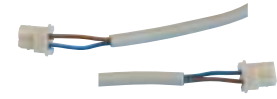
**SYNCHRONISATIONSKABEL FÜR MAXI JOLLY/SYNCHRONISATION CABLE FOR MAXI JOLLY**

ART. NR./CODE	INFO	L	FARBE/COLOUR	PREIS/PRICE
24-485720512	Für MAXI JOLLY Konverter/ For MAXI JOLLY driver	1500	<input type="checkbox"/> white	<b>7,40</b>

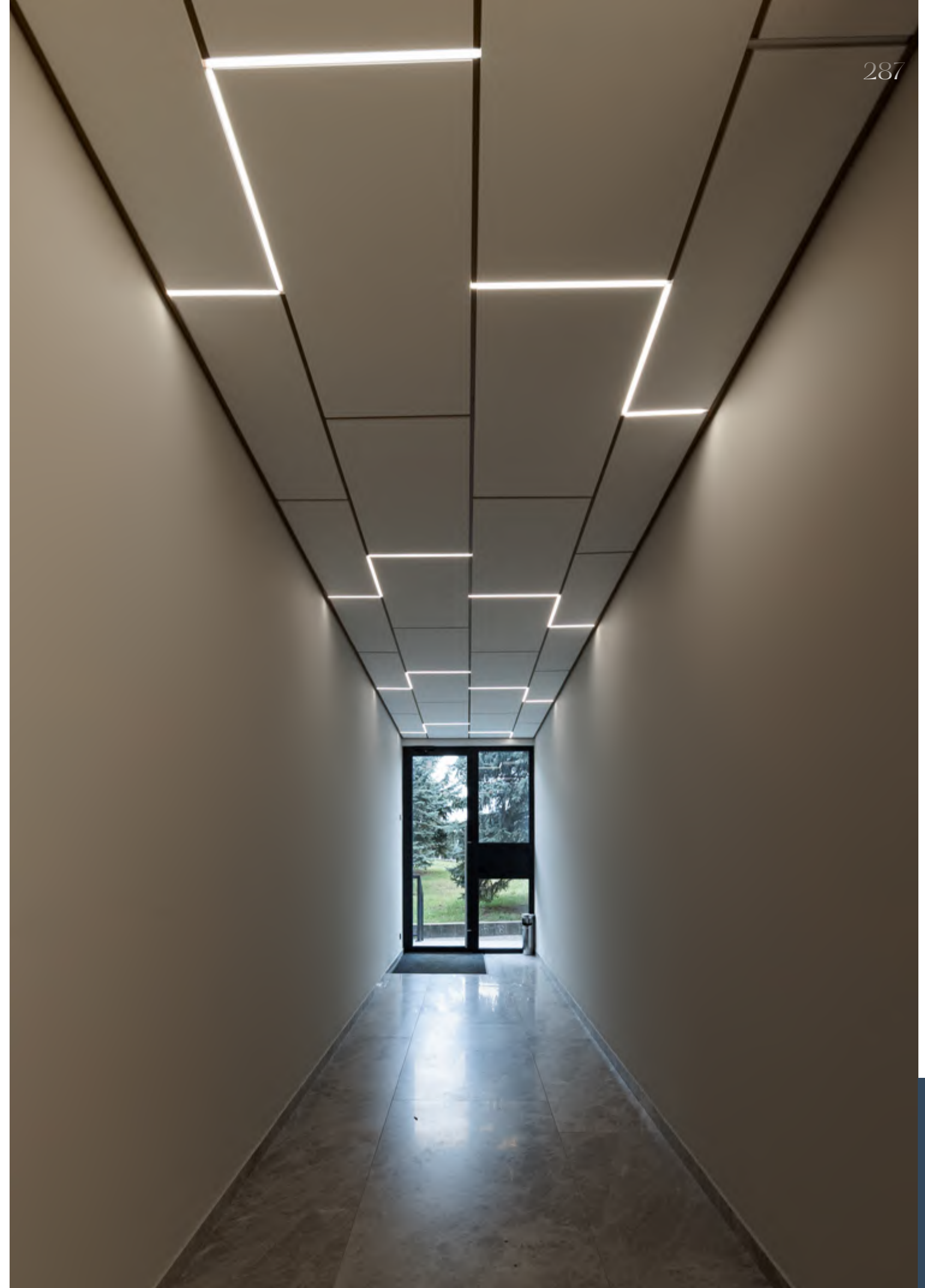





LEUCHTMITTEL  
BULBS





## LED RETROFIT/LED RETROFIT

ART. NR./CODE	INFO	FASSUNG/SOCKET	WATT	KELVIN	EEF	AUSSTRAHLUNGSWINKEL/BEAM ANGLE	PREIS/PRICE
30-347168	A60/CorePro LED Bulb clear	E27	4	2700		>300	4,60
30-380035	A60/CorePro LED Bulb clear		7	2700		>300	4,90
30-347960	ST64/MASTER VLE LED Bulb clear, dim.		6	2700		270	8,20
30-347984	G120/MASTER VLE LED Bulb clear		6	2700		>300	10,00
30-313781	G200/Classic LED Bulb gold, dim.		6,5	1800		>300	65,10



A60

## LED RETROFIT/LED RETROFIT

ART. NR./CODE	INFO	FASSUNG/SOCKET	WATT	KELVIN	EEF	AUSSTRAHLUNGSWINKEL/BEAM ANGLE	PREIS/PRICE
30-324930	A60/MASTER LED Bulb matt, dim.	E27	7	2200-2700		200	14,50
30-325012	A60/MASTER LED Bulb matt		11	2200-2700		>300	18,10



B35 P45

## LED RETROFIT/LED RETROFIT

ART. NR./CODE	INFO	FASSUNG/SOCKET	WATT	KELVIN	EEF	AUSSTRAHLUNGSWINKEL/BEAM ANGLE	PREIS/PRICE
30-377578	B35/CorePro LED Candle	E14	2	2700		>300	4,20
30-347748	CorePro LED Luster		2	2700		>300	4,20



Core Pro QPAR MASTER LED QPAR

## LED RETROFIT/LED RETROFIT

ART. NR./CODE	INFO	FASSUNG/SOCKET	WATT	KELVIN	EEF	AUSSTRAHLUNGSWINKEL/BEAM ANGLE	PREIS/PRICE
30-752531	Core Pro LED Spot	GU10	4	2700		36	6,10
30-707517	Master LED Spot Expert Colour, dim.		4	3000		25	19,20
30-707579	Master LED Spot Expert Colour, dim.		4	3000		36	19,20
30-708118	Master LED Spot VLE, dim.		5	2200-2700		36	8,10
30-707630	Master LED Spot Expert Colour, dim.		6	3000		25	24,00
30-707692	Master LED Spot Expert Colour, dim.		6	3000		36	24,00
30-752517	Core Pro LED Spot		5	2700		36	6,50



AR111

## LED RETROFIT/LED RETROFIT

ART. NR./CODE	INFO	FASSUNG/SOCKET	WATT	KELVIN	EEF	AUSSTRAHLUNGSWINKEL/BEAM ANGLE	PREIS/PRICE
30-333932	Master LED Spot Expert Colour, dim.	G53	11	2700		24	47,90
30-333994			11	3000		24	47,90
30-333956			11	2700		24	47,90
30-334014			11	3000		40	47,90
30-333819			15	2700		40	54,00



Core Pro Master LED

## LED RETROFIT/LED RETROFIT

ART. NR./CODE	INFO	FASSUNG/SOCKET	WATT	KELVIN	EEF	AUSSTRAHLUNGSWINKEL/BEAM ANGLE	PREIS/PRICE
30-307063	MR16 Core Pro LED Spot	GU 5,3	5	2700		36	9,40
30-307186	MR16 MASTER LED Spot VLE, dim.		6	2700			16,80
30-307209	MR16 MASTER LED Spot VLE, dim.		6	3000			16,80
30-307322	MR16 MASTER LED Spot VLE, dim.		8	2700			24,00



QT 14

## LED RETROFIT/LED RETROFIT

ART. NR./CODE	INFO	FASSUNG/SOCKET	WATT	KELVIN	EEF	AUSSTRAHLUNGSWINKEL/BEAM ANGLE	PREIS/PRICE
30-303898	Core Pro LED Capsule	G9	2	2700		300	12,40
30-303935			3				13,20
30-657802			5				26,40



QT 9

## LED RETROFIT/LED RETROFIT

ART. NR./CODE	INFO	FASSUNG/SOCKET	WATT	KELVIN	EEF	AUSSTRAHLUNGSWINKEL/BEAM ANGLE	PREIS/PRICE
30-767655	Core Pro LED Capsule	G4	2	2700		300	10,30
30-767754			3				14,40

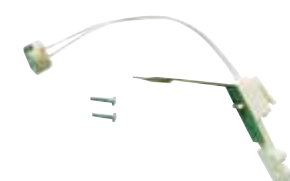

## FASSUNG GU5,3/SOCKET GU5,3

ART. NR./CODE	INFO	L	PREIS/PRICE
259-502990	mit Klemme und Zugentlastung, 12V NV/ with clamp and strain relief, 12V NV	115	2,60

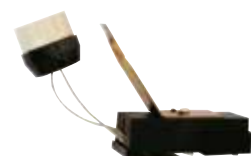

## FASSUNG GU10/SOCKET GU10

ART. NR./CODE	INFO	PREIS/PRICE
259-502991	mit Klemme und Zugentlastung, 230V HV/ with clamp and strain relief, 1230V HV	4,80



Unsere Produkte mit dem 24h Logo sind ab sofort auf Wunsch innerhalb von 24h versandbereit! Achtung: Unser 24h READY TO DELIVER Angebot gilt für den EU Raum!/  
Our products with the 24h logo are now ready for dispatch within 24h on request! Attention: Our 24h READY TO DELIVER offer is valid for the EU area!



Jetzt einfach im Webshop bestellen/Order now in our webshop:



## LIEFER- UND VERKAUFSBEDINGUNGEN/TERMS OF DELIVERY AND SALE

Mit Erscheinen dieses Kataloges verlieren alle bisherigen Preise ihre Gültigkeit. Wir liefern ausschließlich nach unseren gültigen Liefer- und Verkaufsbedingungen. Die Ware bleibt bis zur vollständigen Bezahlung im Eigentum der Molto Luce GmbH. Es gelten unsere allgemeinen Geschäftsbedingungen, abrufbar auf [www.moltoluce.com](http://www.moltoluce.com).

With the publication of this catalogue, all previous prices lose their validity. We deliver exclusively according to our valid delivery and sales conditions. The goods remain the property of Molto Luce GmbH until payment has been made in full. Our general terms and conditions apply, available at [www.moltoluce.com](http://www.moltoluce.com).

## HAFTUNGSAUSSCHLUSS UND NUTZUNGSRECHT/DISCLAIMER AND RIGHT OF USE

Alle Daten in diesem Katalog haben rein informativen Wert. Die Molto Luce GmbH behält sich das Recht vor, die Daten ohne vorhergehende Bekanntgabe oder Begründung zu ändern. Alle Maße sind in Natur zu prüfen. Zudem sind manche, im Katalog abgebildeten Produkte Bildretuschen oder Renderings, die ausschließlich zur Veranschaulichung der Einsatzmöglichkeiten dienen. Für mögliche Irrtümer, Satz- oder Druckfehler sowie Farbabweichungen übernimmt die Molto Luce GmbH keinerlei Haftung. Inhalte und Bilder aus diesem Katalog dürfen ohne Zustimmung der Molto Luce GmbH weder, bearbeitet, vervielfältigt noch veröffentlicht werden.

All data in this catalogue has purely informative value. Molto Luce GmbH reserves the right to modify the data without prior notice or justification. All measurements are to be checked in nature. In addition, some products shown in the catalogue are picture retouchings or renderings which serve exclusively to illustrate the application possibilities. Molto Luce GmbH accepts no liability for possible errors, typesetting or printing errors or colour deviations. Contents and pictures from this catalogue may not be edited, reproduced or published without the consent of Molto Luce GmbH.

## QR-CODE SCANNEN UND ALLE WICHTIGEN INFOS ZM PRODUKT ERHALTEN/ SCAN QR-CODE AND GET ALL IMPORTANT INFORMATION ABOUT THE PRODUCT

Scannen sie den QR-Code der Produkte und erhalten sie sämtliche benötigte Informationen wie z.B. Preise, Lagerstand, Datenblatt, Montageanleitungen, LTD Dateien, ULD-Dateien, 3-DS Dateien und Ausschreibungstexte auf ihr Tablet oder Mobiltelefon./

Click the QR code of the products and get all the information you need, such as prices, stock levels, data sheets, mounting instructions, LTD files, ULD files, 3-DS files and tender texts on your mobile phone or tablet.



KALIO SQUARE R

INFORMATION	LEISTUNG	mA	LUMEN	CRI>	KELVIN	L x B x ET	DA L x B	FARBE	REFL.	ART.NR.
Einbaustrahler, Aluminiumdruckguss, Feinstruktur matt pulverbeschichtet, schwenkbar 45°, zurückversetzte Lichtquelle, exkl. Konverter	LED 8W	250	860	90	2700	96 x 96 x 83	80 x 80	weiß	24°	308-30023500
	LED 8W	250	860	90	2700	96 x 96 x 83	80 x 80	schwarz	24°	308-30023600
	LED 8W	250	860	90	2700	96 x 96 x 83	80 x 80	weiß	38°	308-30033500
	LED 8W	250	860	90	2700	96 x 96 x 83	80 x 80	schwarz	38°	308-30033600
	LED 8W	250	900	90	3000	96 x 96 x 83	80 x 80	weiß	24°	308-30029500
	LED 8W	250	900	90	3000	96 x 96 x 83	80 x 80	schwarz	24°	308-30029600
	LED 8W	250	900	90	3000	96 x 96 x 83	80 x 80	weiß	38°	308-30039500
	LED 8W	250	900	90	3000	96 x 96 x 83	80 x 80	schwarz	38°	308-30039600

## MOLTO LUCE - EIN LEITBETRIEB/MOLTO LUCE - A LEAD COMPANY

Molto Luce führt das Qualitätszeichen der Leitbetriebe Austria. Damit werden Unternehmen ausgezeichnet, die nicht auf kurzfristige Gewinne setzen, sondern auf nachhaltigen Unternehmenserfolg. Betriebe, die durch die Markt- und Werteorientierung zur Entwicklung der Region und Branche beitragen. [www.leitbetriebe.at](http://www.leitbetriebe.at)

Molto Luce carries the quality mark of the leading Austrian companies. It is awarded to companies that do not rely on short-term profits, but on sustainable corporate success, companies that contribute to the development of the region and industry through market and value orientation. [www.leitbetriebe.at](http://www.leitbetriebe.at)



Leitbetrieb  
Österreich

## MOLTO LUCE - TOP SUPPLIER RETAIL 2019/MOLTO LUCE - TOP SUPPLIER RETAIL 2019

Molto Luce wurde als Lösungspartner des EHI Energiemanagement-Award-Preisträgers Metro Cash & Carry Österreich GmbH in der Kategorie „Pilotfilialen mit vorbildlicher Energieeffizienz/Nachhaltigkeit“ mit dem Topp Supplier Retail Award 2019 ausgezeichnet.

In den Augen der Jury haben wir mit einem besonders erfolgreichen Konzept zur Energieeinsparung und zum ressourcenschonenden Einsatz von Energie in der Filiale unseres Partners einen wesentlichen Beitrag geleistet.

Molto Luce was awarded the Top Supplier Retail Award 2019 in the category „Pilot stores with exemplary energy efficiency/sustainability“ as solution partner of the EHI Energy Management Award winner Metro Cash & Carry Austria GmbH.





**DIMMEN VON LED & LEUCHTSTOFFLAMPEN/DIMMING OF LEDS AND FLUOROSCENT BULBS**

**DIMMEN DALI - TASTER/DIMMING DALI - PUSH BUTTON**

nur DALI EVGs mit integrierter Touch DIM Funktion/only DALI ECGs with integrated touch DIM function für max. 2 EVGs möglich, 1-Phasen Betrieb möglich/for max. 2 ECGs possible, 1-phase operation possible

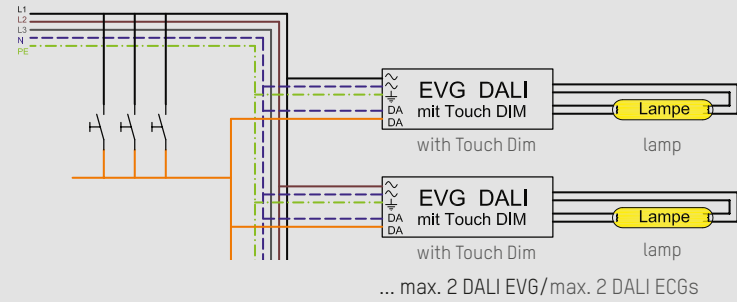

Schalten und Dimmen mit allen handelsüblichen Tastern/switching and dimming with all commercial push buttons

**DIMMEN DALI - DALI MCU**

alle DALI EVGs

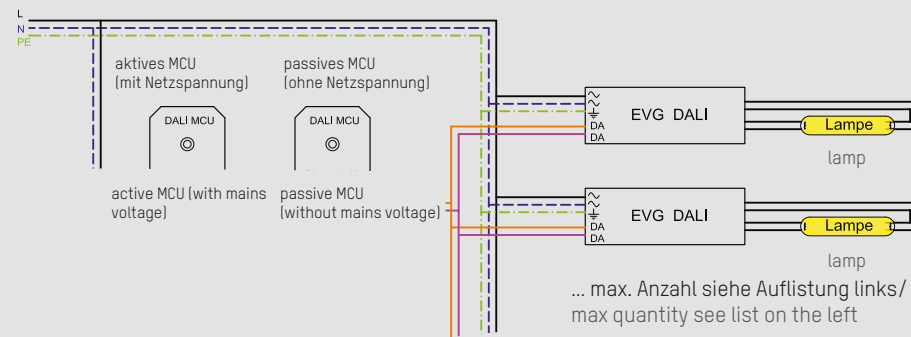

Schalten und Dimmen mit dem DALI Drehrad MCU/switching and dimming with DALI rotary knob MCU

je aktivem MCU ist ein passives MSU anschließbar, insgesamt sind maximal 4 MCU möglich.

- One passive MSU can be connected per active MCU; a maximum of 4 MCUs are possible in total.
- 1 aktives MCU: max. 25 DALI EVG      1 active MCU: max. 25 DALI ECGs
- 1 aktives MCU + 1 passives MCU: max. 25 DALI EVG      1 active MCU + 1 passive MCU: max. 25 DALI ECGs
- 2 aktive MCU: 50 DALI EVG      2 active MCU: 50 DALI ECGs
- 2 aktive MCU + 2 passives MCU: max. 50 DALI EVG      2 active MCUs + 2 passive MCUs: max. 50 DALI ECGs
- 3 aktive MCU: 75 DALI EVG      3 active MCU: 75 DALI ECGs
- 3 aktive MCU + 1 passives MCU: max. 75 DALI EVG      3 active MCUs + 1 passive MCU: max. 75 DALI ECGs
- 4 aktive MCU: max. 100 DALI EVG      4 active MCU: max. 100 DALI ECGs

**DIMMEN DALI - DALI REPEATER SO**

alle DALI EVGs, für max. 64 EVGs/all DALI ECGs, for max. 64 ECGs

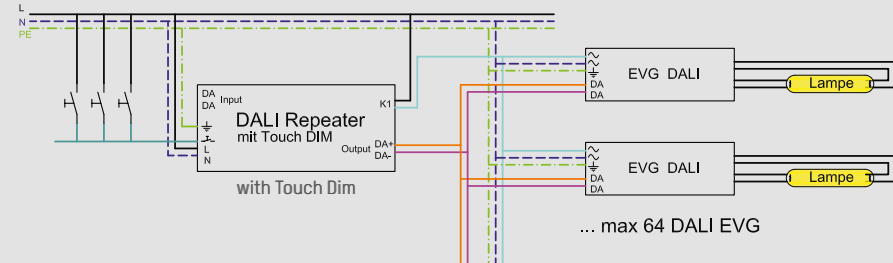

**LED - HINWEISE ZUR VERKABELUNG**

Der Anschluss von elektrischen Verbrauchern an das elektrische Stromnetz unterliegt bestimmten Kriterien, diese sind Spannung, Strom, Polarität und Frequenz, und wir unterscheiden wie folgt:

**1. Spannung**

Alle Verbraucher, die die gleiche Spannung benötigen, werden parallel an die Spannungsquelle angeschlossen. Die Höhe des Stroms, der durch die einzelnen Verbraucher fließt, wird durch den Verbraucher bestimmt.

**Transformatoren** konventioneller Bauart sind Geräte welche Wechselspannung in der Höhe verändern können, z.B. von 230V/50Hz auf 12V/50Hz.

**Transformatoren** elektronischer Bauart sind Geräte welche Wechselspannung in der Höhe verändern können, dabei aber auch die Frequenz verändern, z.B. von 230V/50Hz auf 12V/20kHz. 12V Glühlampen kommen damit zurecht, andere Verbraucher aber nicht, auch keine 12V LEDs. (Ausnahme LED Retrofit)

**LED-WIRING INSTRUCTIONS**

The connection of electrical load to the electrical grid is subject to certain criteria, these are voltage, current, polarity and frequency, and we differentiate as follows:

**1. voltage**

All loads that require the same voltage are connected in parallel to the voltage source. The amount of current flowing through the individual loads is determined by the load.

Conventional transformers are devices that can change the level of alternating voltage e.g. from 230V/50Hz to 12V/50Hz.

Electronic transformers are devices that can change the level of alternating voltage voltage, but which can also change the frequency, e.g. from 230V/50Hz to 12V/20kHz. 12V light bulbs can cope with this, but other consumers cannot, including no 12V LEDs. (Exception LED retrofit)

**LED-KONVERTER RGB 1-10V & PUSH & IR/LED- DRIVER RGB 1-10V & PUSH& IR**

**DIMMEN WEISSER LED STRIPES 24V/DIMMING WHITE LED STRIPES 24V DIMMEN PER TASTER/DIMMING WITH PUSH BUTTON**

kurzer Tastendruck zum Ein-/Ausschalten, langer Tastendruck zum Auf-/Abdimmen, mit Auto-Stop bei minimalen und maximalen Werten mit dimmbarem Betriebsgerät VSTR 120 (230V-50Hz auf 0-24V DC) 24V Konverter (100W) für maximal 1 x 6,9m weißes LED Strip 24V (je 14.4W/lfm)

short press to switch on/off, long press to dim up/down, with auto-stop at minimum and maximum values with dimmable control gear VSTR 120 (230V-50Hz to 0-24V DC) 24V converter (100W) for a maximum of 1 x 6.9m white LED strip 24V (14.4W/running meter each)

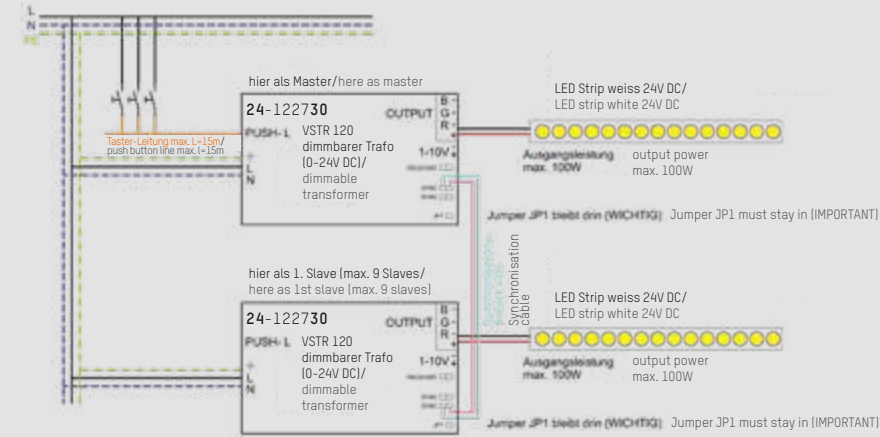

**DIMMEN WEISSER LED STRIPES 24V/DIMMING WHITE LED STRIPES DIMMEN 1-10V/DIMMING 1-10V**

Dimmen mit Potentiometer am 1-10V Eingang mit dimmbarem Betriebsgerät VSTR 120 (230V-50Hz auf 0-24V DC) 24V Konverter (100W) für maximal 1 x 6,9m weißes LED Strip 24V (je 14.4W/lfm)

Dimming with potentiometer at 1-10V input with dimmable control gear VSTR 120 (230V-50Hz to 0-24V DC) 24V converter (100W) for max. 1 x 6.9m white LED Strip 24V (14.4W/running meter each)

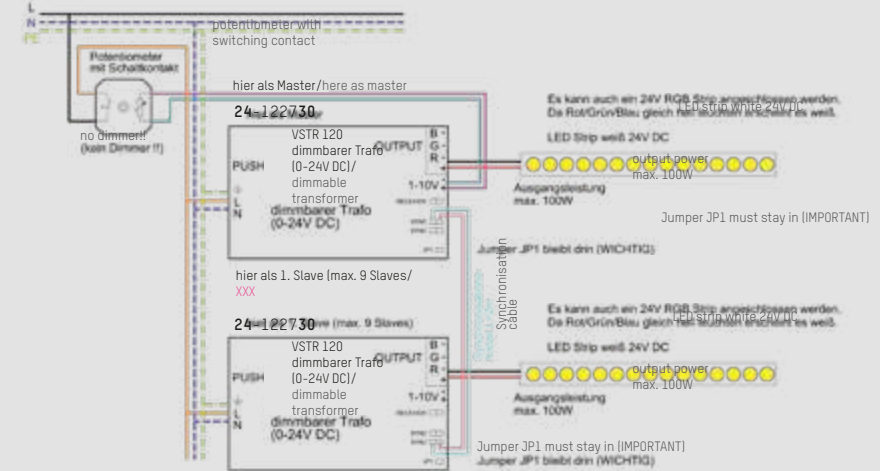

**DIMMEN RGB LED STRIPES 24V/DIMMING RGB LED STRIPES 24V DIMMEN PER FERNBEDIENUNG/DIMMING VIA REMOTE CONTROL**

Infrarotfernbedienung: es können alle drei Farbkanaäle einzeln oder gemeinsam gedimmt werden + einfacher Farbdurchlauf mit dimmbarem Betriebsgerät VSTR 120 (230V-50Hz auf 0-24V DC) 24V Konverter (120W) für maximal 1 x 8,5m weißes LED Strip 24V (je 14.4W/lfm)

Infrared remote control: all three color channels can be dimmed individually or together + simple color flow with dimmable control gear VSTR 120 (230V-50Hz to 0-24V DC) 24V converter (120W) for a maximum of 1 x 8.5m white LED Strip 24V (14.4W/running meter each)

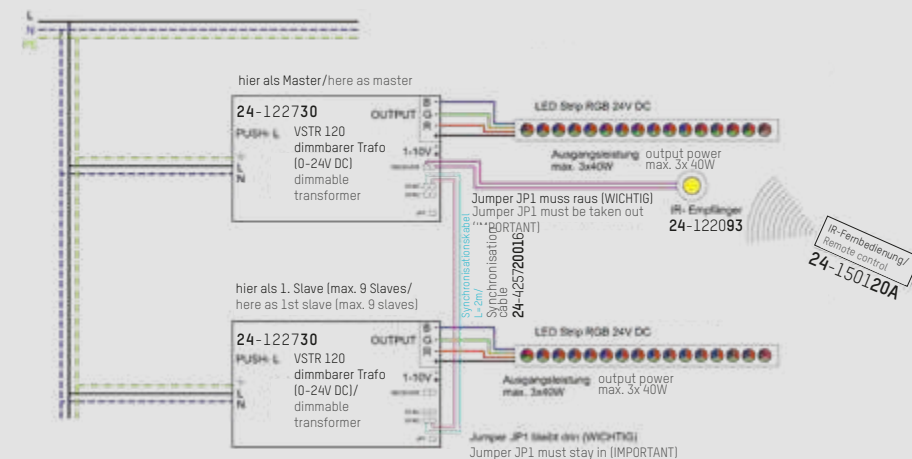



## MAXI JOLLY

### DIMMEN POWER LEDS/DIMMING POWER LEDS DIMMEN PER TASTER/DIMMING VIA PUSH BUTTON

Kurzer Tastendruck zum Ein/Ausschalten, langer Tastendruck zum Auf/Ab-dimmen. Mit Auto-Stop bei min. und max. Werten, die Stellung der DIP-Schalter (DIP switch) legt den Konstantstrom des Konverters am Ausgang fest.

Short press to switch on/off, long press to dim up/down. With auto-stop at min. and max.values, the position of the DIP switches determines the constant current of the converter at the output.

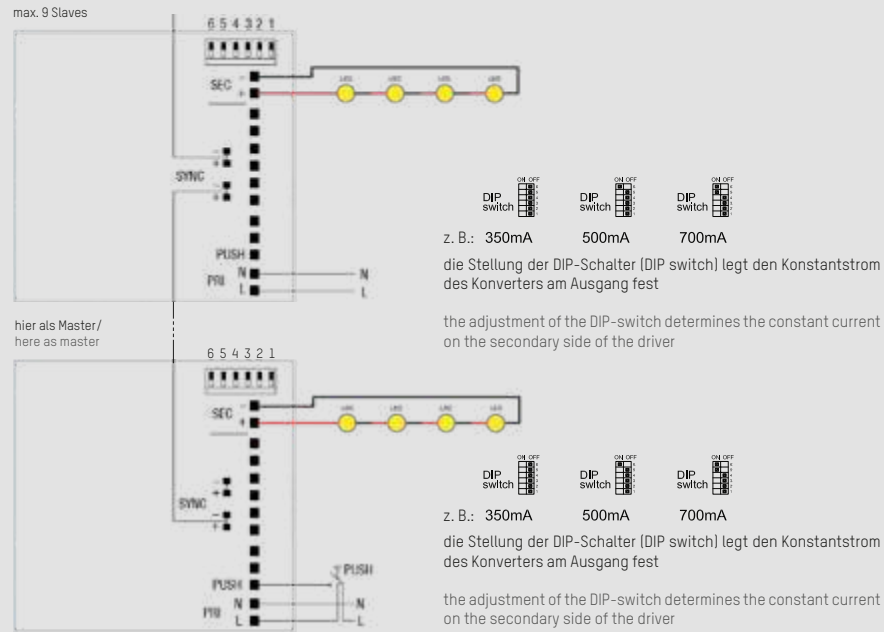

### DIMMEN POWER LEDS/DIMMING POWER LEDS DIMMEN 1-10V/DIMMING 1-10V

Dimmen mit Potentiometer am 1-10V Eingang mit dimmbarem Betriebsgerät MAXI JOLLY, die Stellung der DIP-Schalter (DIP switch) legt den Konstantstrom des Konverters am Ausgang fest.

dimming with potentiometer at the 1-10V input with dimmable MAXI JOLLY control gear, the position of the DIP switch determines the constant current of the converter at the output.

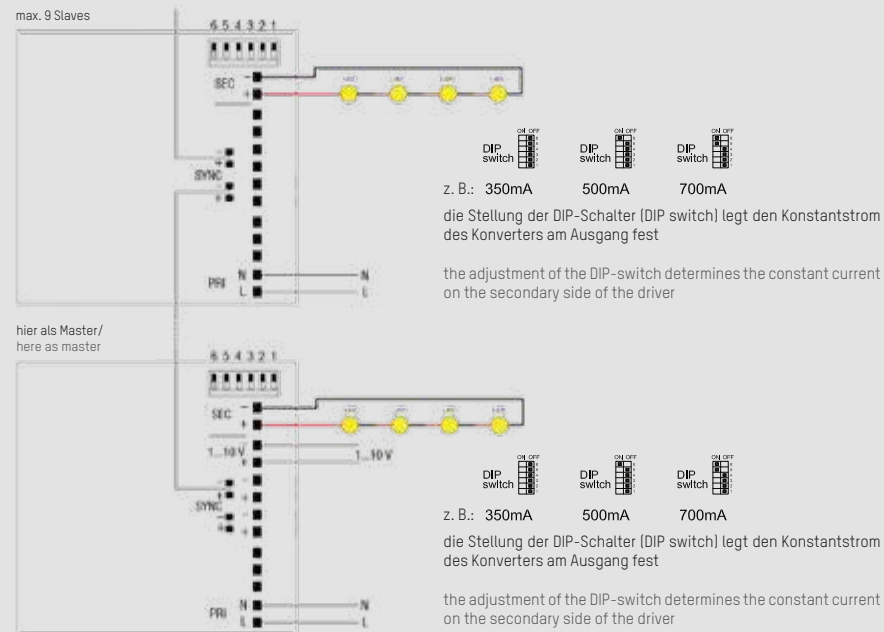

### DIMMEN POWER LEDS/DIMMING POWER LEDS DIMMEN DALI/DIMMING DALI

Dimmen über DALI Steuerung, die Stellung der DIP-Schalter (DIP switch) legt den Konstantstrom des Konverters am Ausgang fest.

dimming via DALI control, the position of the DIP switch determines the constant current of the converter at the output.

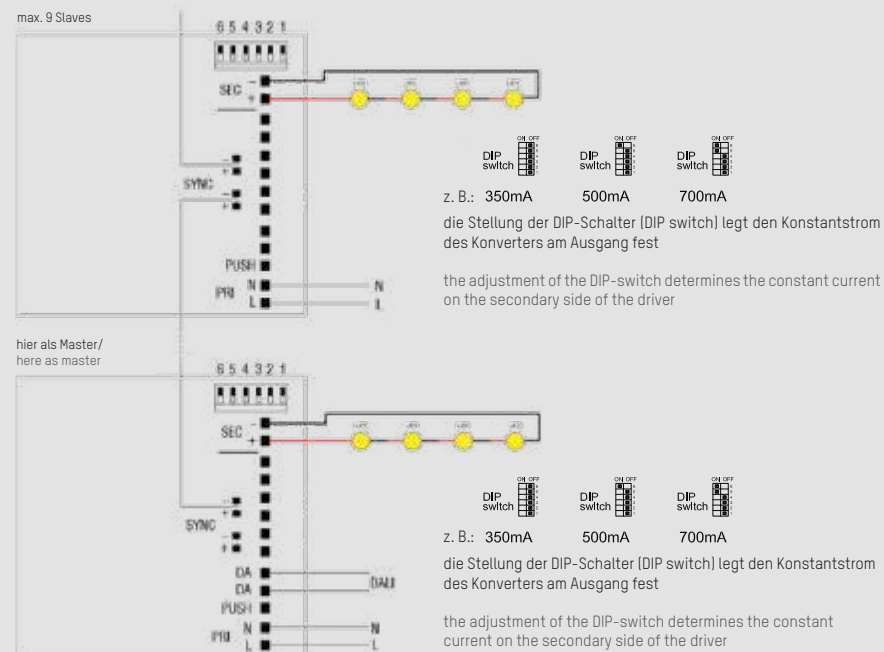

### DALieco ALS MANUELLE TASTENSTEUERUNG/DALIECO AS MANUAL PUSH BUTTON CONTROLLER

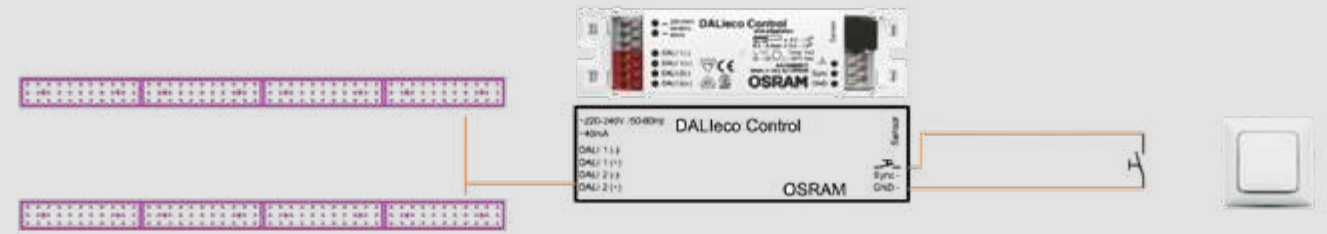

Manuelles Dimmen und Schalten von bis zu 32 EVG's  
Länge des Anschlusskabels zu den Tasten von bis zu 50m, beliebig viele Teilnehmer

Manual dimming and switching up to 32 drivers  
length of the connection cable to the push buttons up to 50m, any number of push buttons connectable

### DALieco ALS MANUELLE 2-KANAL-TASTENSTEUERUNG (kein Sensor angeschlossen)/ DALIECO AS MANUAL 2-CHANNEL-PUSH-BUTTON CONTROLLER (WITHOUT CONNECTED SENSOR)

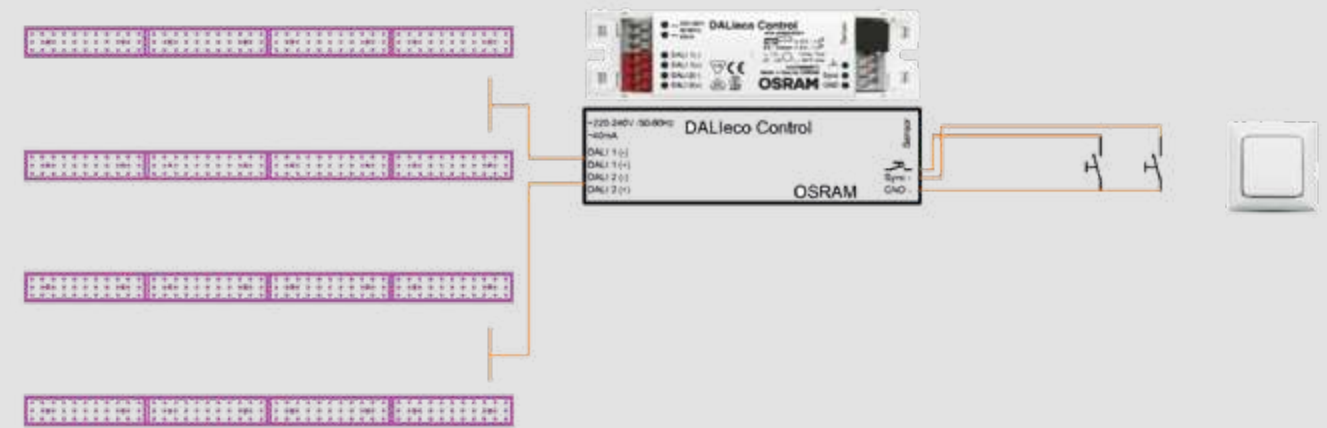

Manuelles Dimmen und Schalten von bis zu 2 x 16 EVGs  
Aktivierung des Tastersteuerungseingangs für Kanal 2 durch gleichzeitiges Drücken beider Taster für 10 Sek.  
Länge des Anschlusskabels zu den Tastern von bis zu 50m, beliebig viele Taster anschließbar

manual dimming and switching of up to 2x 16 drivers activation of the switch control input for channel 2, simultaneous pressing of both push buttons for 10 seconds.  
length of the connection cable to the push buttons up to 50m, any number of push buttons connectable

### DALieco FÜR DIE AUTOMATISCHE LICHTSTEUERUNG VON EINZELLEUCHTEN/EINZELBÜROS /DALIECO FOR AUTOMATIC LIGHT CONTROL OF SINGLE LAMPS/SINGLE OFFICES

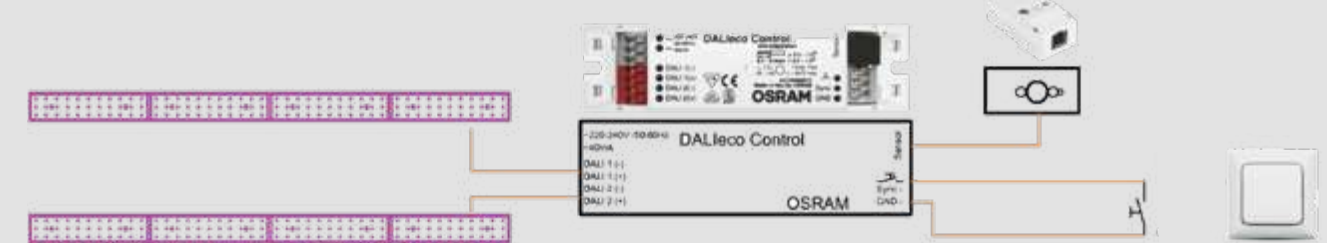

Länge des Anschlusskabels zu den Tastern von bis zu 50m, beliebig viele Taster anschließbar

length of the connection cable to the push buttons up to 50m, any number of push buttons connectable



## UNIVERSALDIMMER/UNIVERSAL DIMMER

Dimmer zur Ansteuerung über DALI, 1 - 10V oder PUSH Dimm. für weisse 24V LED Stripes

Dimmer for control via DALI, 1 - 10V or PUSH Dimm. for white 24V LED Stripes

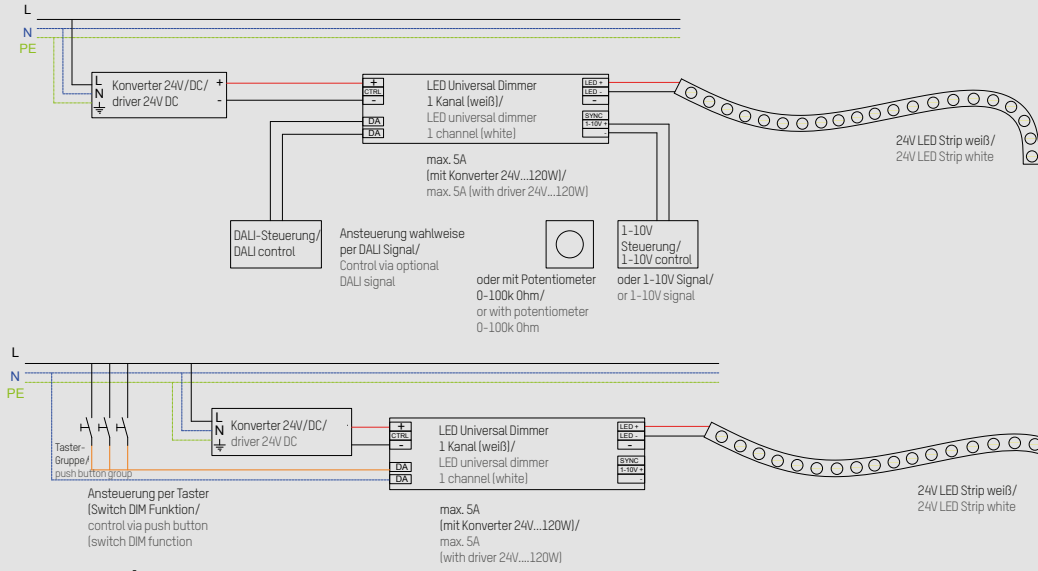

## DMX 200/DMX 200

Dimmen DMX/DALI-RGB FÜR RGB LED 24V STRIPES, für die DMX oder DALI Ansteuerung von max. 2x 5m RGB LED's 24V bei 14,4W/lm (entspricht 144W Gesamtleistung)

Dim DMX/DALI-RGB for RGB LED 24V stripes, for DMX or DALI control of max. 2x 5m RGB LED's 24V at 14.4W/ running meter

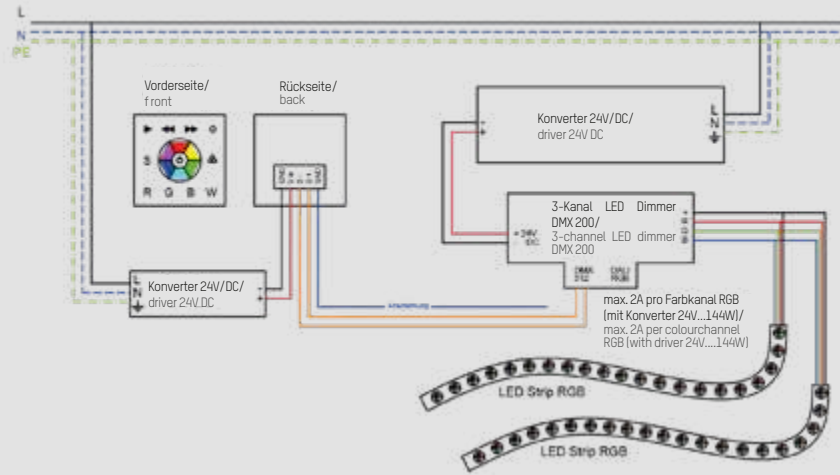

## DMX RGBW DIMMER/DMW RGBW DIMMER

für die DMX Ansteuerung von max. 14m RGBW LED Stripes 24V bei 17,3W/lm (Entspricht 250W Gesamtleistung)

for DMX control of max. 14m RGBW LED Stripes 24V at 17.3W/lm (matches 250W total output)

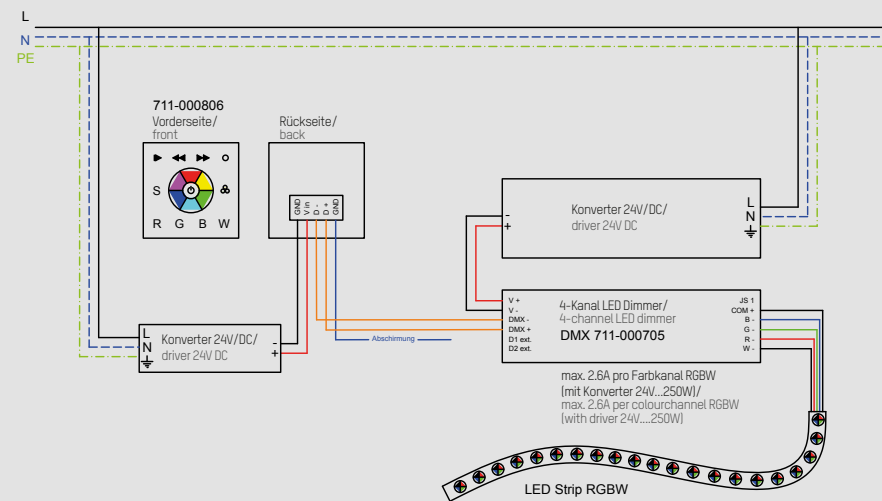

## RGBW FUNKDIMMER/RGBW RADIO DIMMER

Zur Ansteuerung von 24V LED Stripes RGB, RGBW oder weißen 24V LED Stripes. Kommunikation zwischen Controller und Bedienstellen erfolgt über Funk. Optionale APP Steuerung möglich (siehe unten)

For controlling 24V LED Stripes RGB, RGBW or white 24V LED Stripes. Communication between controller and control points via radio. Optional APP control possible (see below)

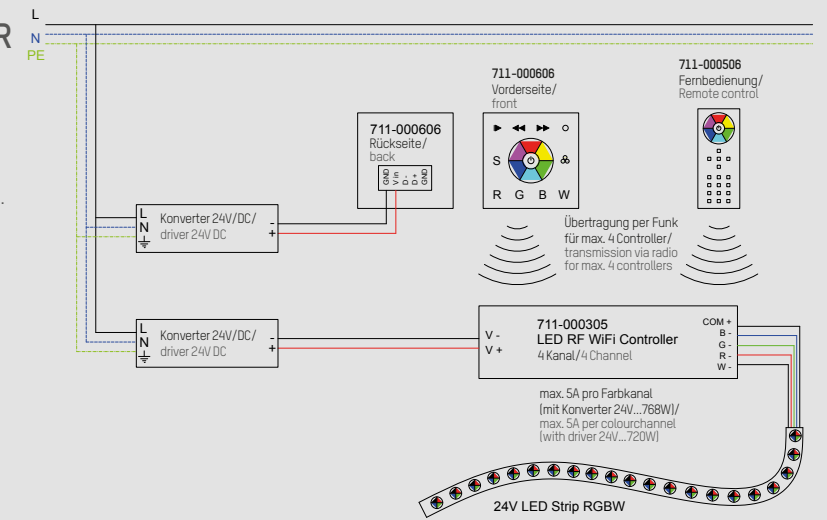

## RGBW FUNKDIMMER/RGBW RADIO DIMMER

APP Steuerung des RGBW Funkdimmers zur Integration in ein haus eigenes WLAN, APP steht zum kostenlosen Download in diversen APP Stores zur Verfügung

APP control of the RGBW wireless dimmer for integration into an in-house WLAN, APP is available for free download in available in various APP stores

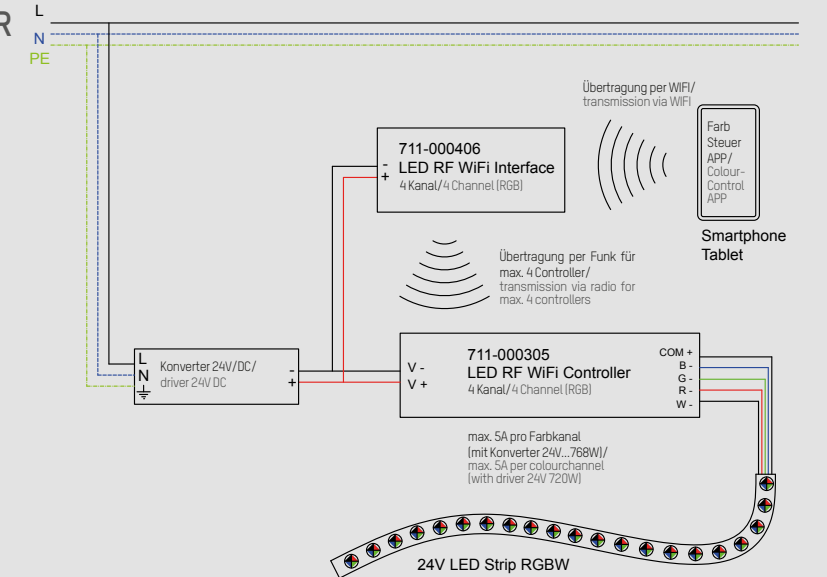

## FUNK DIMMER TUNABLE WHITE/RADIO DIMMER TUNABLE WHITE

2-Kanal Funk Dimmer für die Ansteuerung von Tunable White LED Stripes max. 5A/Kanal, 110-240W/24V

2-channel wireless dimmer for controlling Tunable White LED Stripes max. 5A/channel, 110-240W/24V

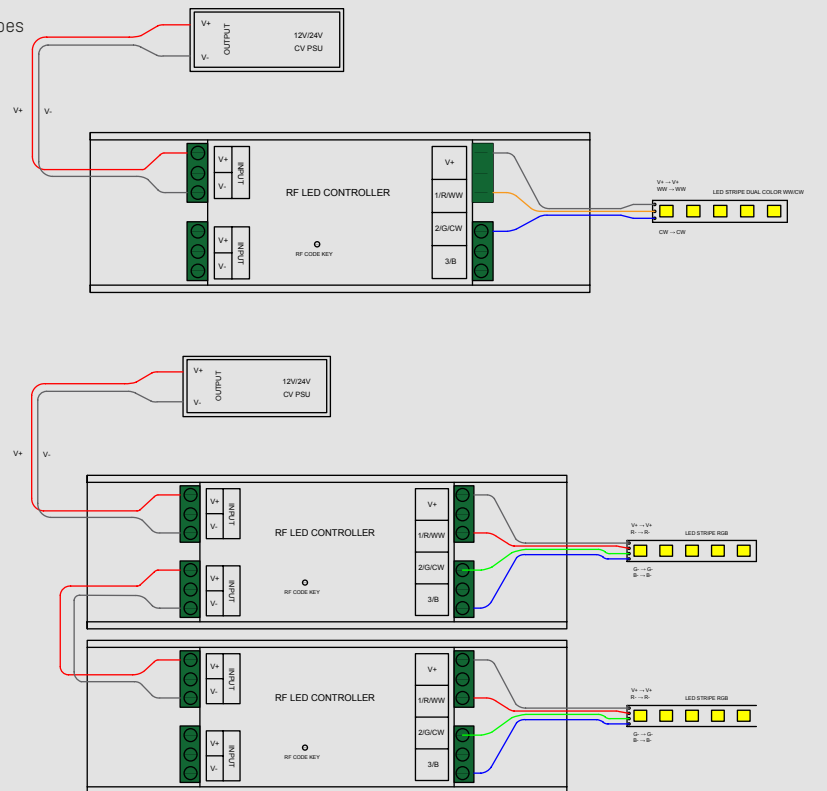



### DALI DT8 / PUSH LED KONVERTER/DALI DT8/ PUSH LED DRIVER

LED Konverter für LED Stripes, dimmbar DALI DT8 Push Dimm. 2 Kanal - max. 75W./LED driver for LED stripes, dimmable DALI DT8 push dimm. 2 channel - max. 75W

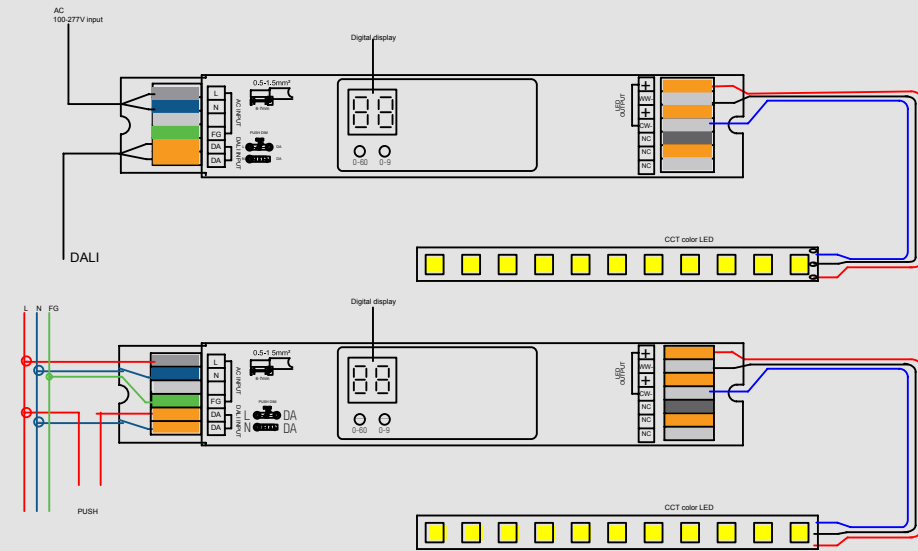

### DALI / PUSH LED KONVERTER/DALI/ PUSH LED DRIVER

LED Konverter für LED Stripes, dimmbar DALI Push Dimm. 2 Kanal - max. 30W. /LED driver for LED stripes, dimmable PUSH dimm. 2 channel - max. 30W

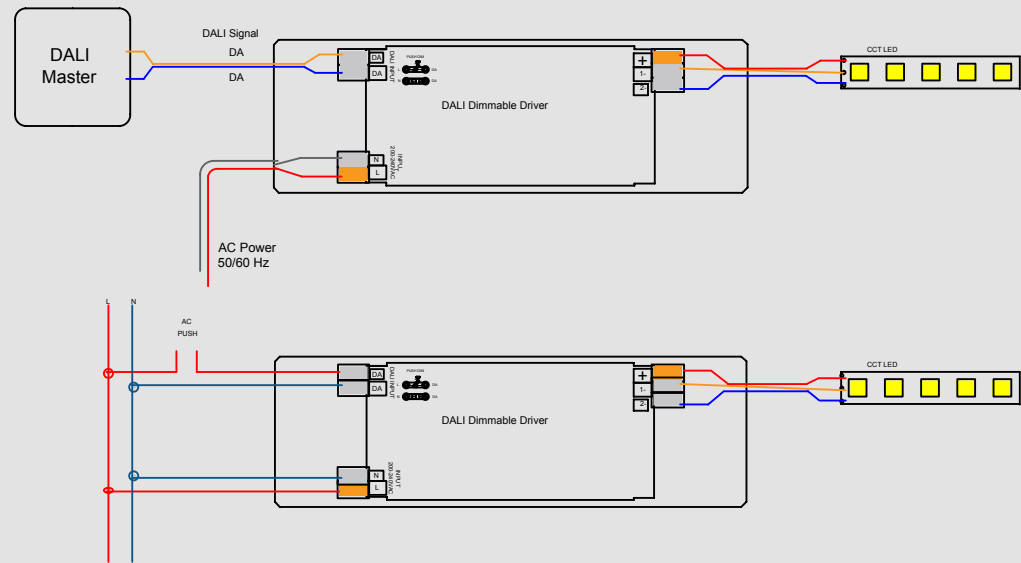

### DALI / PUSH LED KONVERTER/DALI / PUSH LED DRIVER

LED Konverter für LED Stripes, dimmbar DALI Push Dimm. 1 Kanal - max. 150W. /LED driver for LED stripes, dimmable DALI Push dimm. 1 channel - max. 150W

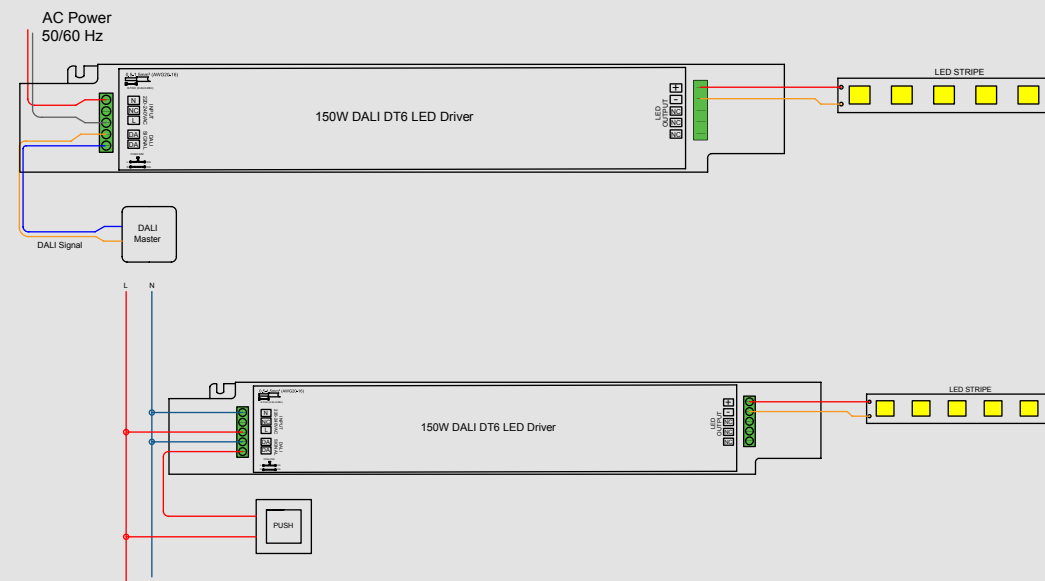

### LED KONVERTER QT DALI/LED DRIVER QT DALI

28-177900 - 50W - DALI LED Konverter für LED Stripes, dimmbar DALI Push Dimm. 1 Kanal - max. 50W./LED driver for LED stripes, dimmable DALI Push Dimm. 1 channel - max. 50W  
 28-177924 - 80W - DALI LED Konverter für LED Stripes, dimmbar DALI Push Dimm. 1 Kanal - max. 80W. /LED driver for LED stripes, dimmable DALI Push Dimm. 1 channel - max. 80W

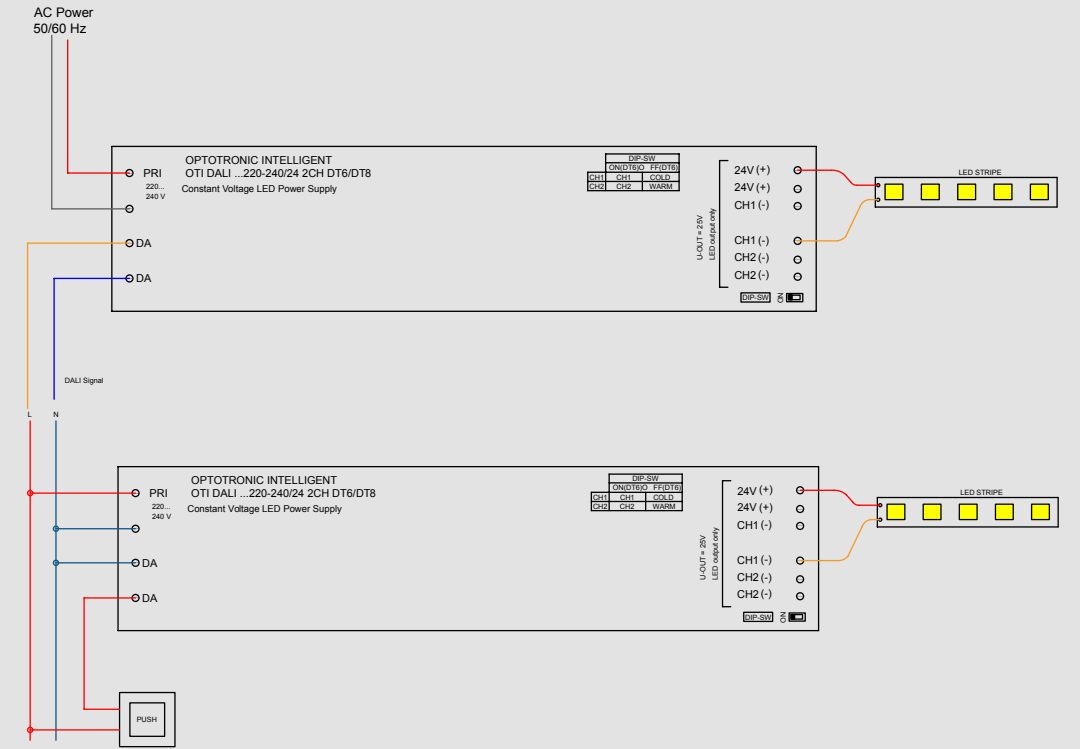

### DALI DT8 / PUSH LED DIMMER - 4 KANAL/DALI DT8 / PUSH LED DIMMER - 4 CHANNEL

Dimmer für LED Stripes, DALI DT8 RGB/W, tunable white, 60-180W/24V/dimmer for LED stripes, DALI DT8 RGB/W, tunable white, 60-180W 24V

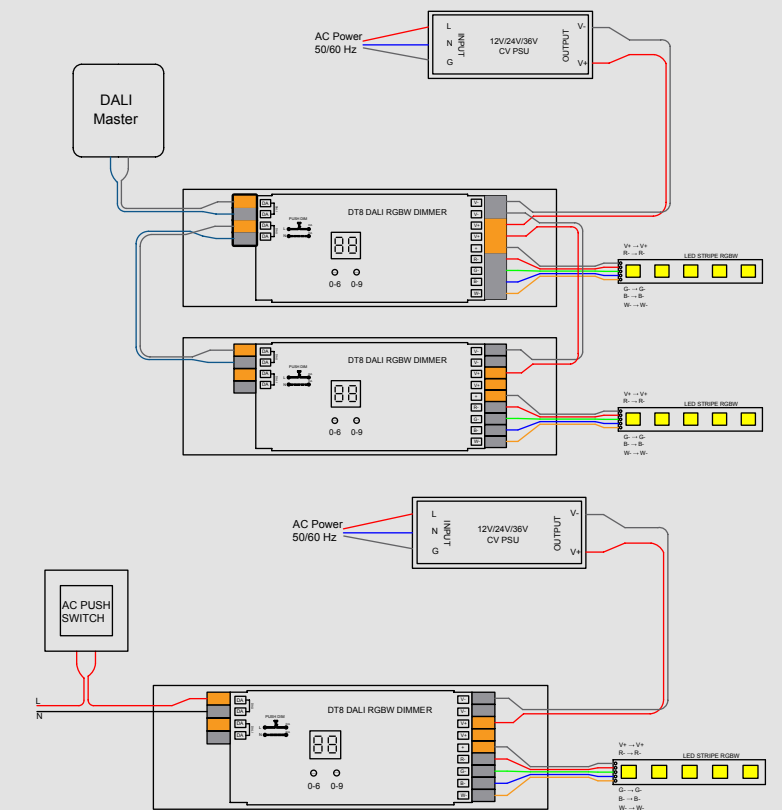



### DALI DT8 / RGBW-TOUCHPANEL

Lichtszenencontroller DALI DT8 RGB/W, 4 Szenen konfigurierbar, Montage in Standard-Einbaudose Ø 68mm.

Light scene controller DALI DT8 RGB/W, 4 scenes configurable, mounting in standard recessed box Ø 68mm.

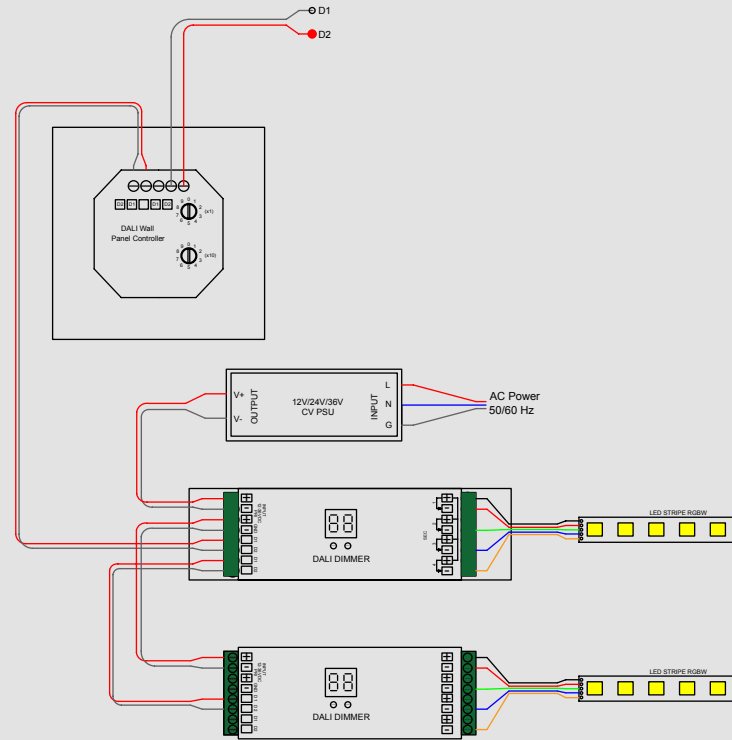

### DALI DT8 TUNABLE WHITE - TOUCHPANEL

Lichtszenencontroller DALI DT8 tunable white, 4 Szenen konfigurierbar, Montage in Standard-Einbaudose Ø 68mm.

Light scene controller DALI DT8 tunable white, 4 scenes configurable, installation in standard recessed box Ø 68mm.

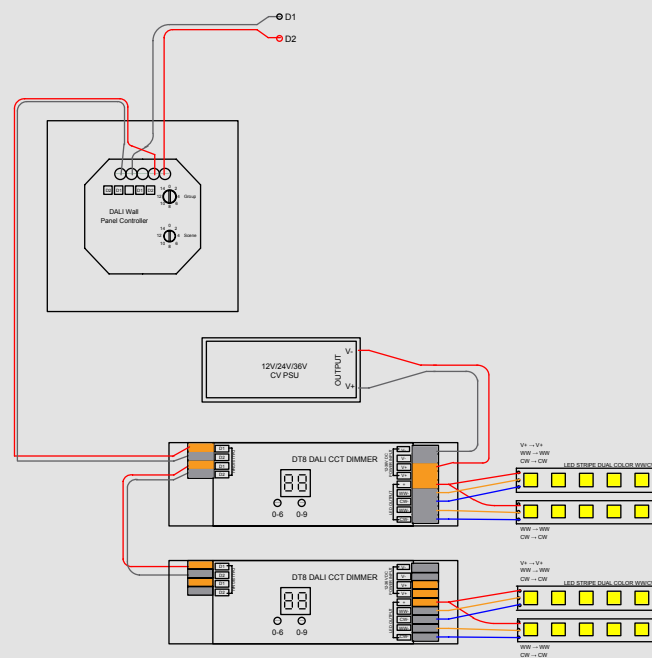

### PUSH BUTTON INTERFACE

Zur Integration von handelsüblichen Tastern in die MOLTO LUCE Smart App. 3 Kanal UP-Dosenmodu

For integrating commercially available push-buttons into the MOLTO LUCE Smart App. 3 channel flush-mounted box module

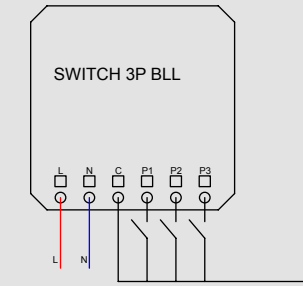

### INTERFACE SMART BLUETOOTH TO DALI

Zur Integration von max. 40 Dalı dimmbaren Leuchten in die MOLTO LUCE Smart App.

For integration of max. 40 Dalı dimmable luminaires in the MOLTO LUCE Smart App.

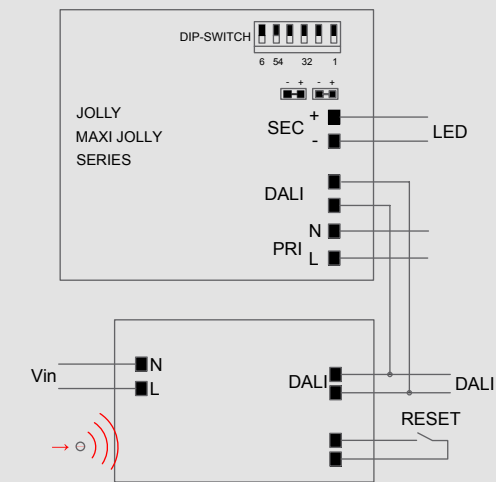





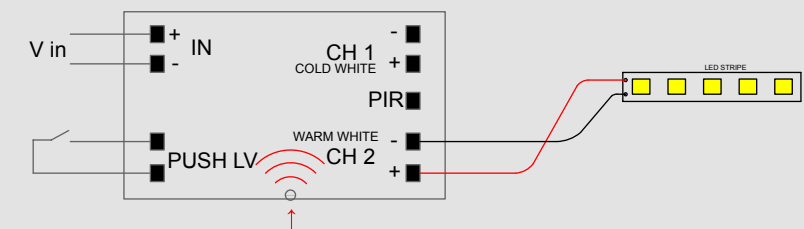



















### BLUETOOTH DIMMER-2 KANAL/BLUETOOTH DIMMER- 2 CHANNEL









BLUETOOTH DIMMER-2 KANAL/bluetoothg dimmer- 2 channel





Symbole/symbols

-  Deckeneinbau/ceiling recessed
-  Deckenaufbau/surface mounted
-  Pendelleuchten/pendant luminaires
-  Wandeinbau/recessed wall
-  Wandaufbau/ceiling wall
-  Decken-Wandeinbau/ceiling-wall recessed
-  Stehleuchte/Floor lamp
-  Decken-Wandaufbau/Surface mounted ceiling-/walllamp
-  Stromschiene/tracklight
-  Bodeneinbau/recessed ground light
-  Poller/bollard
-  Tischleuchte/table lamp
-  Schutzklasse I/protection class I
-  Schutzklasse II/protection class II
-  Schutzklasse III/protection class III
-  IP20 IP-Schutzart/IP-protection class
-  IK02 Stoßfestigkeit/impact protection
-  dimmbar/dimmable
-  DALI 2 dimmbar/DALI 2 dimmable
-  Tastdimmer/touch dimmer
-  Sensor Dimmer/sensor dimmer
-  Energieeffizienz/energy efficiency
-  schwenkbar/tilting
-  schwenkbar/turnable
-  Decken-oder Wandausschnitt rund/ceiling-wall cutout round

-  Decken-oder Wandausschnitt eckig/ceiling-wall cutout square
-  UGR-Wert, je niedriger, desto blendfreier / UGR-value, the lower, the less glare
-  Dim2Warm-Funktion ändert sich die Lichtfarbe wenn man die Leuchte dimmt und damit die Lichtstärke abnimmt / Dim2Warm-function changes the light colour when the lamps is dimmed down
-  Tunable-White-Funktion ändert sich die Lichtfarbe bei gleicher Lichtstärke / Tunable-white-function changes light colour at the same light output
-  48 Volt Gleichstromspannung/48 volt direct current
-  Erlaubt Montage eines elektrischen Betriebsgerätes auf Werkstoffen, deren Entflammverhalten nicht bekannt sind / permits the installation of an electrical control gear on materials whose flammability behavior is not known
-  Max. Oberflächentemperatur an Betriebsgeräten / max. surface temperature on the driver
-  Unabhängiger Konverter: Betriebsgerät auch zur Verwendung außerhalb von Leuchten / independent driver: driver also can be used outside of the luminaire
-  Kurzschlussfestes Sicherheitsbetriebsgerät / short curcuit safe driver

IP - SCHUTZARTEN/IP PROTECTION CLASSES

1. Ziffer/Digit	Berührungsschutz/touch protection	Schutz gegen das Eindringen von Fremdkörpern und Staub / protection against penetration of foreign objects or dust
IP 0X	ungeschützt/no protection	kein besonderer Schutz/no special protection
IP 1X	Schutz gegen Fremdkörper > 50 mm / protection against foreign objects >50mm	Größere Körperteile wie eine Hand (jedoch keine Schutzmaßnahme gegen bewusste Berührung / bigger body part e.g. hands (no protection against conscious touch)
IP 2X	Schutz gegen Fremdkörper > 12 mm / protection against foreign objects >12mm	Finger und dergleichen bis 80 mm Länge; Fremdkörper >12 mm Durchmesser / fingers and similar up to 80mm length; foreign objects >12mm diameter
IP 3X	Schutz gegen Fremdkörper > 2,5 mm / protection against foreign objects >2,5mm	Werkzeuge, Drähte usw. mit Durchmesser oder Dicke > 2,5 mm; Fremdkörper > 2,5mm / tools, wires etc. with diameter or thickness >2,5mm; foreign objects >2,5mm
IP 4X	Schutz gegen Fremdkörper >1 mm / Protection against foreign bodies	Drähte oder Streifen > 1mm; Fremdkörper > 1 mm Durchmesser / wires or stripes >1mm; foreign objects >1mm diameter
IP 5X	Staubschutz/dust protection	Eindringen von Staub wird nicht völlig verhindert, aber Staub dringt nicht in solchen Mengen ein, dass ordnungsgemäßer Betrieb behindert wird. / penetration of dust not completely prevented, but dust cant penetrate in such high quantity to prevent normal operation
IP 6X	Staubdicht/dust-tight	kein Eindringen von Staub/no penetration of dust
2. Ziffer/Digit	Wasserschutz/Water protection	Schutz gegen das Eindringen von Wasser/Protection against the ingress of water
IP X0	ungeschützt/no protection	kein besonderer Schutz/no special protection
IP X1	Schutz gegen Tropfwasser / protection against dripping water	Tropfwasser (senkrecht fallende Tropfen) verursacht keine Schädigung. / bigger body part e.g. hands (no protection against conscious touch)
IP X2	Schutz gegen Tropfwasser unter 15° / protection against dripping water under 15°	Senkrecht fallende Tropfen dürfen keine Schädigung bewirken, wenn das Gehäuse bis zu 15° aus seiner bestimmungsgemäßen Gebrauchslage gekippt wird. / vertical falling drips must not cause damages, even if the housing is tilted 15° to its intended use position
IP X3	Schutz gegen Sprühwasser / protection against spray-water	Sprühwasser darf aus einer Neigung bis 60° gegen die Senkrechte keine Schädigung verursachen. / spray-water with an inclination up to 60° to the vertical axis must not cause any damage
IP X4	Schutz gegen Spritzwasser / protection against splash-water	Spritzwasser aus beliebiger Richtung darf keine Schädigung verursachen / splash-water from any direction must not cause any damages
IP X5	Schutz gegen Strahlwasser / protection against jetting water	Strahlwasser aus einer Düse aus beliebiger Richtung darf keine Schädigung verursachen. / Jet-water out of a nozzle from any direction must not cause and damages
IP X6	Schutz gegen schwere See / protection against heavy sea	Schwere See oder Strahlwasser unter hohem Druck dürfen nicht in gefahrbringender Menge in das Gehäuse eindringen. / Heavy seas or water jets under high pressure must not enter the enclosure in dangerous quantities.
IP X7	Schutz gegen das Eintauchen (t) / protection against immersion in water	Eindringen von Wasser in gefahrbringender Menge dürfen beim Eintauchen in Wasser unter vorgegebenen Bedingungen hinsichtlich Druck und Zeit nicht stattfinden. / Ingress of water in hazardous quantities must not occur during immersion in water under specified conditions of pressure and time.
IP X8	Schutz gegen Untertauchen (t ...m) / protection against submersion in water	Das Gerät ist unter Bedingungen, die vom Hersteller genannt werden, für Dauerbetrieb unter Wasser geeignet. Anmerkung: Üblicherweise bedeutet dies, dass das Gerät vollständig abgedichtet ist. Jedoch kann dies bei bestimmten Geräten auch bedeuten, dass Wasser zwar eindringt, jedoch keine Schädigung verursacht. / Under conditions specified by the manufacturer, the appliance is suitable for continuous operation under water. Note: This usually means that the device is completely sealed. However, with certain appliances this can also mean that water penetrates but does not cause any damage.



